

Wall Filler

3" Wide
WF3X30
WF3X48
WF3X60

6" Wide
WF6X30
WF6X48
WF6X60



Base Filler
30" High

BF3
BF6



Wall Overlay Filler
Includes Filler and Overlay

3" Wide
WOF3X12
WOF3X15
WOF3X18
WOF3X21
WOF3X24
WOF3X27
WOF3X30
WOF3X36
WOF3X42
WOF3X48
WOF3X60

6" Wide
WOF6X12
WOF6X15
WOF6X18
WOF6X21
WOF6X24
WOF6X27
WOF6X30
WOF6X36
WOF6X42
WOF6X48
WOF6X60

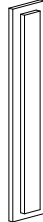

Base Overlay Filler
30" High
Includes Filler and Overlay

BOF3
BOF6

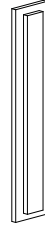

Wall Fluted Filler

3" Wide
WFF3X12
WFF3X15
WFF3X18
WFF3X21
WFF3X24
WFF3X27
WFF3X30
WFF3X36
WFF3X42
WFF3X48
WFF3X60

6" Wide
WFF6X12
WFF6X15
WFF6X18
WFF6X21
WFF6X24
WFF6X27
WFF6X30
WFF6X36
WFF6X42
WFF6X48
WFF6X60

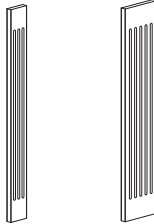

DESIGN NOTE: Flutes Start 3" From Top and End 3" From Bottom

Vanity Overlay Filler
26.5" High
Includes Filler and Overlay

VOF3
VOF6

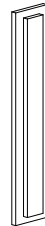

Base Fluted Filler
30" High

BFF3
BFF6

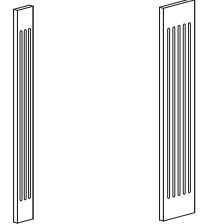

Wall Corner Filler

WCF3X3X30
WCF3X3X42



Base Corner Filler
30" High

BCF3X3

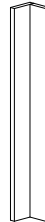

Angle Filler

(For designing 3" or 6" angled set back or set forward into a line of cabinetry.)

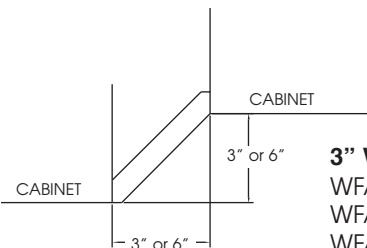

3" Wide
WFA3X30
WFA3X36
WFA3X42
WFA3X48
WFA3X54
WFA3X60

6" Wide
WFA6X30
WFA6X36
WFA6X42
WFA6X48
WFA6X54
WFA6X60

Angle Filler

30" High
(For designing 3" or 6" angled set back or set forward into a line of cabinetry.)

BFA3X30
BFA6X30

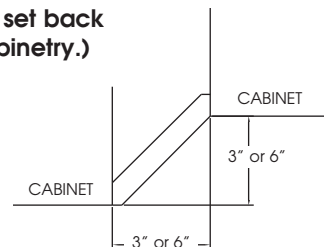

MISCELLANEOUS

Tall Filler

Actual
Height

TF3X84	(79 1/2")
TF3X96	(91 1/2")
TF6X84	(79 1/2")
TF6X96	(91 1/2")



End Panels

1/2" Thick
Front Edge Banded
Matching Woodgrain Laminate
Both Sides

Base
BEP2434
Wall
WEP1230
WEP1260



Base End Panel Arched
BEPA2434

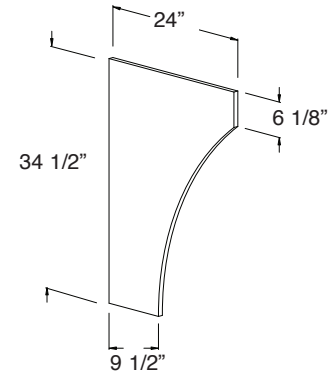

Tall Overlay Filler Includes Filler and Overlay

Actual
Height

TOF3X84	(79 1/2")
TOF3X90	(85 1/2")
TOF3X96	(91 1/2")
TOF6X84	(79 1/2")
TOF6X90	(85 1/2")
TOF6X96	(91 1/2")



Wall End Panel With Filler 12" Deep

1 1/2" Wide	3" Wide
WEPF1 1/2X30	WEPF3X30
WEPF1 1/2X48	WEPF3X48
WEPF1 1/2X60	WEPF3X60

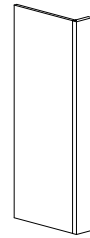

(Panel Shown Left)

Tall Fluted Filler

Actual
Height

TFF3X84	(79 1/2")
TFF3X90	(85 1/2")
TFF3X96	(91 1/2")
TFF6X84	(79 1/2")
TFF6X90	(85 1/2")
TFF6X96	(91 1/2")

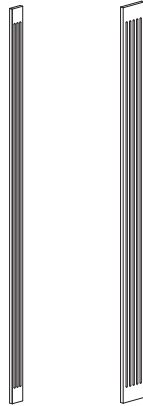

Base End Panel With Filler
1/2" Thick, 24" Deep,
34 1/2" High
1 1/2" or 3" Filler Attached
Matching Woodgrain Laminate
Both Sides

Panel Left
BEPF1 1/2L
BEPF3L
Panel Right
BEPF1 1/2R
BEPF3R

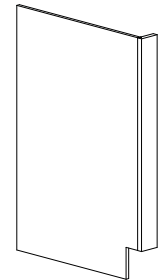

(Panel Shown Left)

Angle Filler

(For designing 3" or 6" angled set back or set forward into a line of cabinetry.)

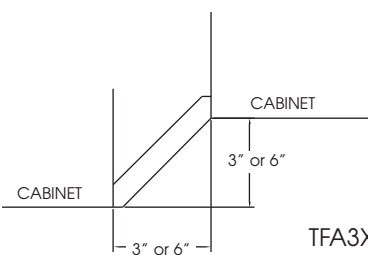

TFA3X96
TFA6X96

Deluxe End Panels
1/4" Thick Plywood veneer panel.
Used for finishing cabinet sides.
Applied on jobsite.

DEP1230
DEP1260
DEP2434
DEP2496

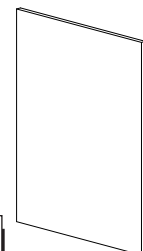

DESIGN NOTE: When using Deluxe End Panels you must use the Plywood Trim Moulding on page M11.

Paper Backed Wood Veneer

Applied to cabinet side at job site.
Not available with white stain.

PBWV1218	PBWV1296
PBWV1231	PBWV2435
PBWV1243	PBWV2496

Plywood Return Option

Available on a per cabinet basis.
Both sides of the cabinet will have a plywood return.
All exterior sides will be finished in the wood species and stain color chosen for the job. All interior sides are a natural birch Woodgrain Laminate.
Please specify PRO

Tall End Panel
1/2" Thick, 96" High
Front Edge Banded
Matching Woodgrain Laminate
Both Sides

TEP1896
TEP2196
TEP2496
TEP2796

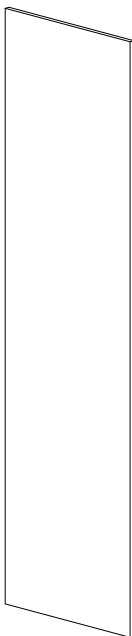

DESIGN NOTE: When using the Plywood Return Option on this item, the item will be 3/4" thick instead of 1/2" thick.

Tall End Panel With Filler
1/2" Thick, 24" Deep
1 1/2" or 3" Filler Attached
Matching Woodgrain Laminate
Both Sides

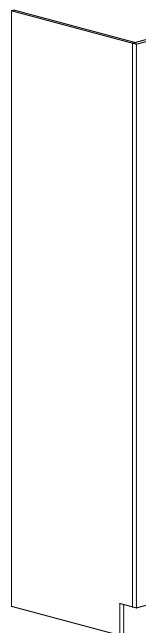

(Panel Shown Left)

24" Deep Panel Left
TEPF1 1/2 X 8424L
TEPF1 1/2 X 9024L
TEPF1 1/2 X 9624L
TEPF3X8424L
TEPF3X9024L
TEPF3X9624L
Panel Right
TEPF1 1/2 X 8424R
TEPF1 1/2 X 9024R
TEPF1 1/2 X 9624R
TEPF3X8424R
TEPF3X9024R
TEPF3X9624R

27" Deep Panel Left
TEPF1 1/2 X 8427L
TEPF1 1/2 X 9027L
TEPF1 1/2 X 9627L
TEPF3X8427L
TEPF3X9027L
TEPF3X9627L
Panel Right
TEPF1 1/2 X 8427R
TEPF1 1/2 X 9027R
TEPF1 1/2 X 9627R
TEPF3X8427R
TEPF3X9027R
TEPF3X9627R

Tall End Panel With Filler and Flush Toe
1/2" Thick,
1 1/2" or 3" Filler Attached
Matching Woodgrain Laminate
Both Sides

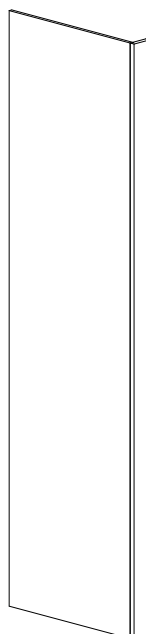

(Panel Shown Left)

24" Deep Panel Left
TEPF1 1/2 X 8424FTL
TEPF1 1/2 X 9024FTL
TEPF1 1/2 X 9624FTL
TEPF3X8424FTL
TEPF3X9024FTL
TEPF3X9624FTL
Panel Right
TEPF1 1/2 X 8424FTR
TEPF1 1/2 X 9024FTR
TEPF1 1/2 X 9624FTR
TEPF3X8424FTR
TEPF3X9024FTR
TEPF3X9624FTR

27" Deep Panel Left
TEPF1 1/2 X 8427FTL
TEPF1 1/2 X 9027FTL
TEPF1 1/2 X 9627FTL
TEPF3X8427FTL
TEPF3X9027FTL
TEPF3X9627FTL
Panel Right
TEPF1 1/2 X 8427FTR
TEPF1 1/2 X 9027FTR
TEPF1 1/2 X 9627FTR
TEPF3X8427FTR
TEPF3X9027FTR
TEPF3X9627FTR

MISCELLANEOUS

Appliance Panels

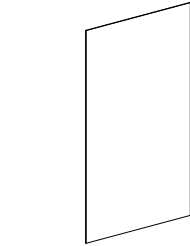
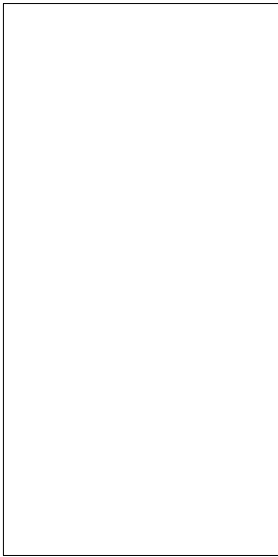

Flat Panel
1/4" Wood Veneer Panel
APA
24"W X 34 1/2"H

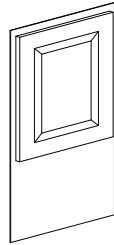

Deluxe Door Style Panel
1/4" Wood Veneer Panel
with Door Attached
APD
24" W X 34 1/2"H

Refrigerator Door Panels
Flat Panel
1/4" Wood Veneer Panel
RDPA
48" W X 96" H

door size
F/O 23.5" w x 21.75" h
S/O 22" w x 21" h

Roll Tray Kit

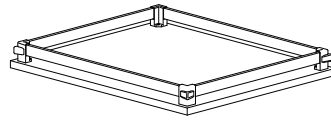

RT15	RT27
RT18	RT30
RT21	RT33
RT24	RT36

Knife Block

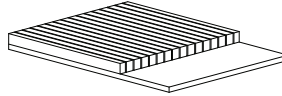

	#of slots
KB18	12
KB21	15

Cutlery Divider

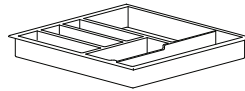

CD18	CD24
CD21	

Finished Panels Wood Veneer Panel

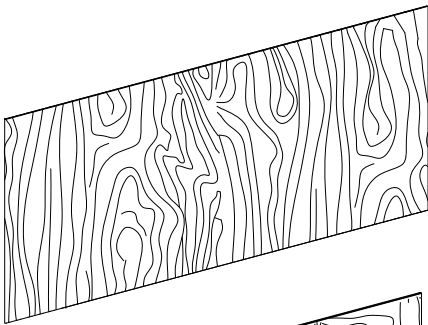

Vertical Grain
FP(V)3448X1/4
FP(V)3448X3/4

FP(V)3496X1/4
FP(V)3496X3/4

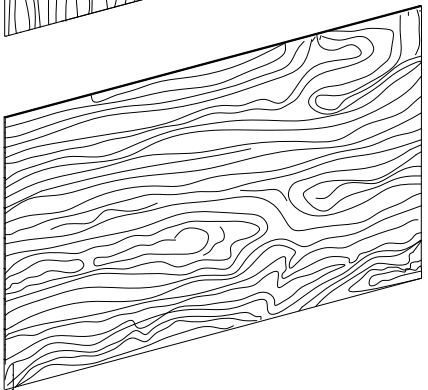

Horizontal Grain
FP(H)4896X1/4
FP(H)4896X3/4

Drawer Front Bin



DFB21	DFB24
DFB30	DFB36

Sliding Towel Bar Kit

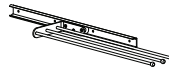

STBK

Stemware Holder

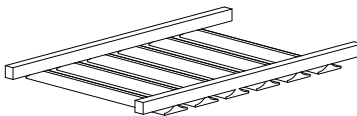

SH24
SH30
SH36

Spice Rack Door

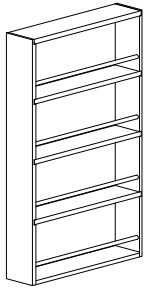

Cabinet Width
 SRD18 18"
 SRD21 21"

Scribe Moulding

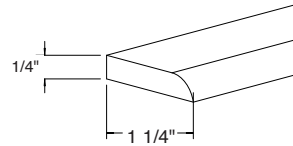

SM48
 SM96

Tray Divider Kit

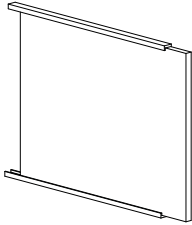

TD-KIT
 Includes 1 tray divider and
 2 tray divider tracks.
 Sized for a 24" deep cabinet.

Batten Moulding

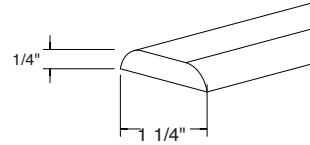

BM48
 BM96

Base Wastebasket Kit

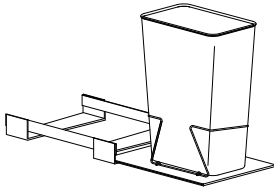

BW1KIT
 Fits a 15" or 18" Wide Cabinet

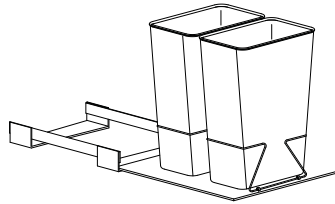

BW2KIT
 Fits a 21" or 24" Wide Cabinet

Inside Corner Moulding

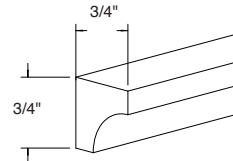

ISC48
 ISC96

Outside Corner Moulding

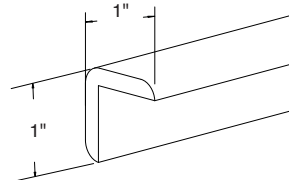

OSC48
 OSC96

Lazy Susan Kit

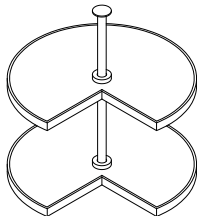

Shelf diameter:
 36" cabinet is 31"
 33" cabinet is 28"

BASE
 LSKB2KIT-
 2 Kidney Shaped Shelves

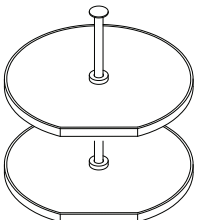

Shelf diameter:
 36" cabinet is 31"
 33" cabinet is 28"

BASE
 LSRB2KIT
 2 Round Shaped Shelves

WALL
 LSRW2KIT
 2 Round Shaped Shelves
 LSRW3BKIT
 3 Round Shaped Shelves

Quarter Round Moulding

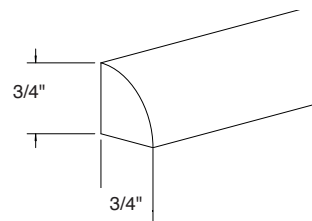

QR48
 QR96

Plywood Trim Moulding

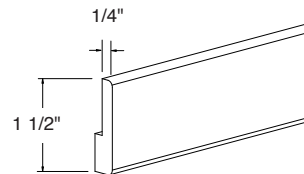

PTM48
 PTM96

MISCELLANEOUS

Chair Rail Moulding

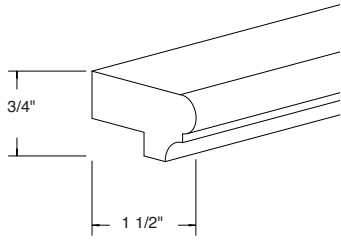

3/4" Traditional

CRM-T3/4X48
CRM-T3/4X72
CRM-T3/4X96

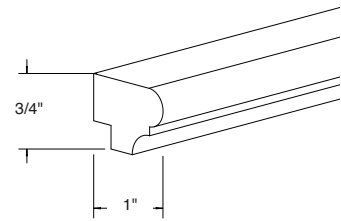

1/4" Traditional

CRM-T1/4X48
CRM-T1/4X72
CRM-T1/4X96

Deluxe Cove Moulding

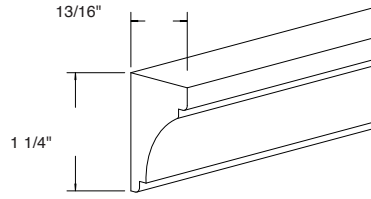

DCM48
DCM72
DCM96

Dentil Moulding

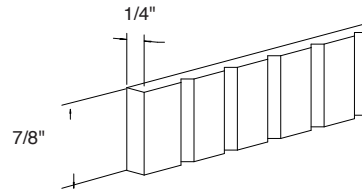

DM48

Countertop Edge Trim

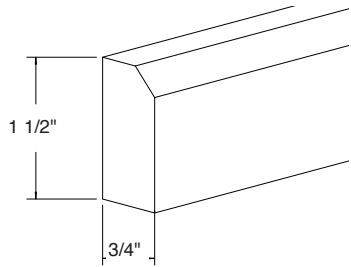

Bevel

CET-B48
CET-B72
CET-B96

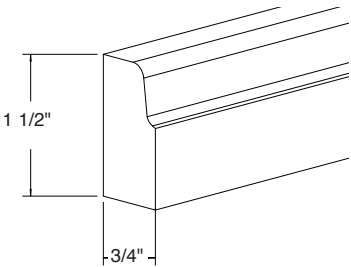

Ogee

CET-OG48
CET-OG72
CET-OG96

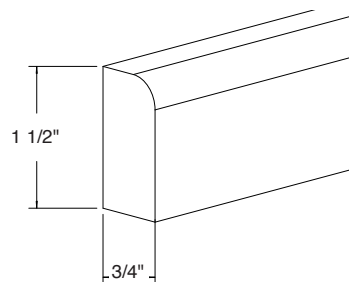

Radius

CET-R48
CET-R72
CET-R96

Plate Rail

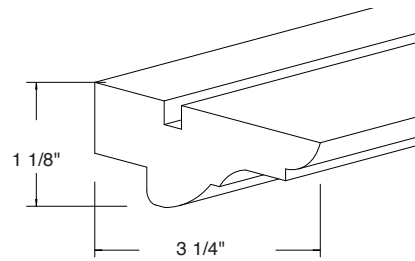

PR48
PR72
PR96

Spindle Rail Wood

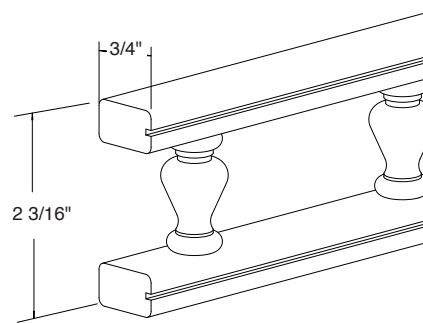

SRW48
SRW72
SRW96

Corner Post

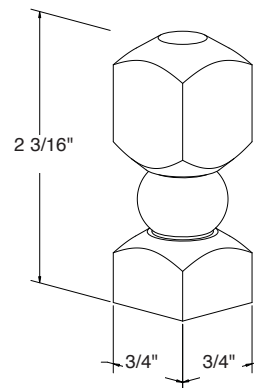

CP

Casing

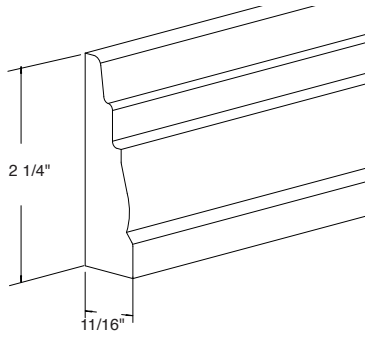

Traditional
C-T48
C-T72
C-T96

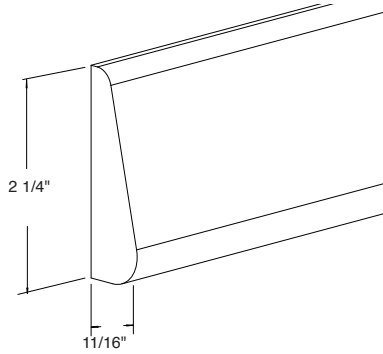

Contemporary
C-C48
C-C72
C-C96

Mini Crown Moulding

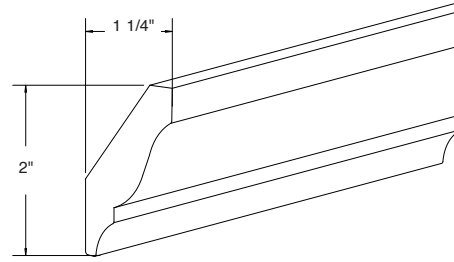

MCM48
MCM72
MCM96

Crown Moulding

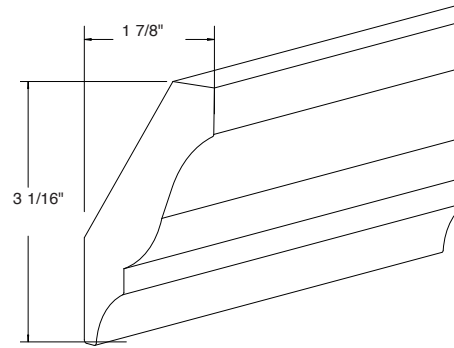

CM48
CM72
CM96

Furniture Base Moulding

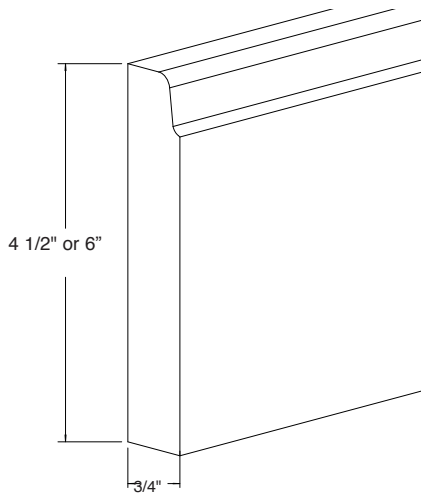

Traditional
FBM-T48
FBM-T72
FBM-T96

FBM-T6X48
FBM-T6X72
FBM-T6X96

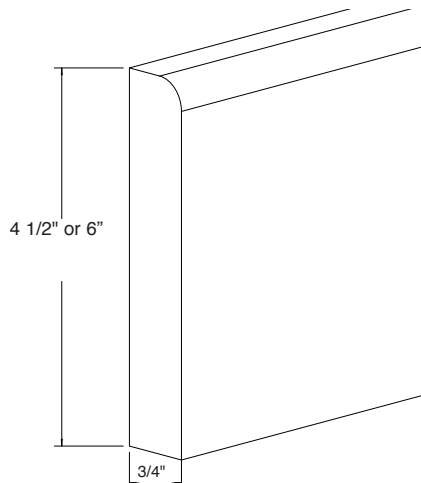

Contemporary
FBM-C48
FBM-C72
FBM-C96

FBM-C6X48
FBM-C6X72
FBM-C6X96

Imperial Crown

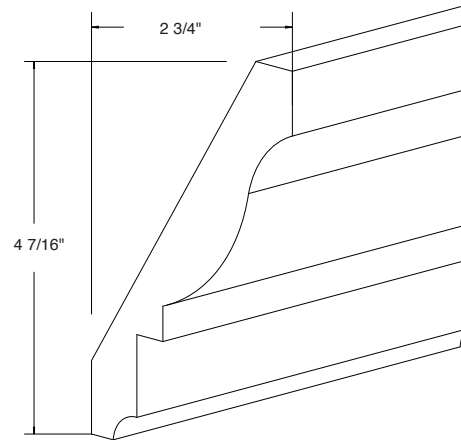

CM148
CM172
CM196

Crown Moulding Angled

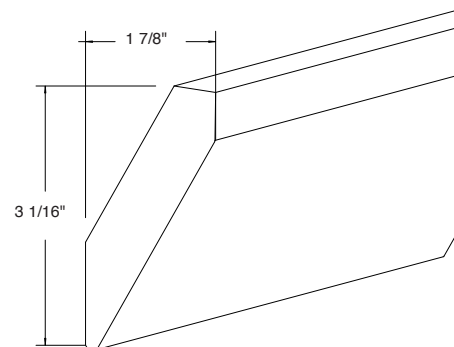

CMA48
CMA72
CMA96

MISCELLANEOUS

Moulding Cleats/Spacers

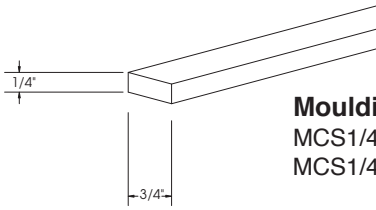

Moulding Cleats/Spacers
MCS1/4x48
MCS1/4x96

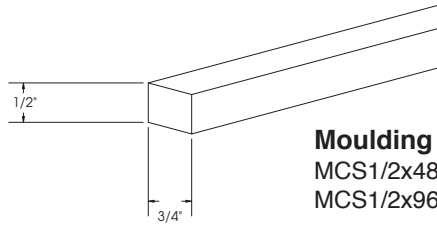

Moulding Cleats/Spacers
MCS1/2x48
MCS1/2x96

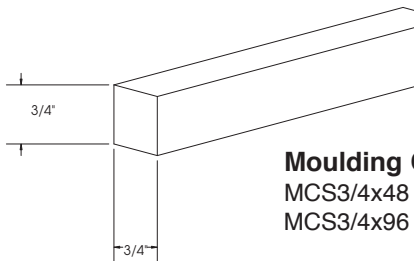

Moulding Cleats/Spacers
MCS3/4x48
MCS3/4x96

Rope Moulding

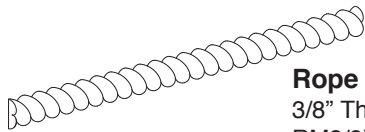

Rope Moulding
3/8" Thick
RM3/8X48
RM3/8X96

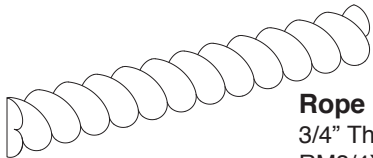

Rope Moulding
3/4" Thick
RM3/4X48
RM3/4X96

Square 4 Sides

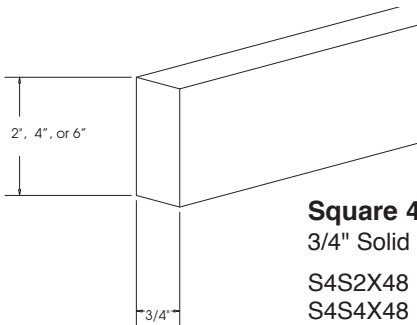

Square 4 Sides
3/4" Solid Wood
S4S2X48 S4S2X96
S4S4X48 S4S4X96
S4S6X48 S4S6X96

Valances

Trimable up to 6"

Straight 4 1/2" High



V37	V55	V84
V43	V61	V96
V49	V73	

Arched 4 1/2" High

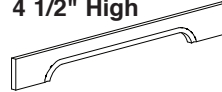

VA37	VA55	VA84
VA43	VA61	VA96
VA49	VA73	

Scrolled 4 1/2" High

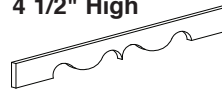

VS37	VS55	VS84
VS43	VS61	VS96
VS49	VS73	

Frieze

6 3/4" High

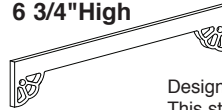

Design Note:
This style is not trimable.

VFC27	VFC39	VFC54	VFC78
VFC30	VFC42	VFC60	VFC84
VFC33	VFC45	VFC66	VFC90
VFC36	VFC51	VFC72	VFC96

Countertop Wood Support
8" High X 8" Wide x 1 1/2" Thick

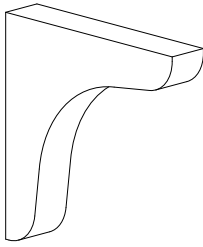

CWS

Toekick
Standard Toekick

1/2" PBC matching woodgrain laminate to match the wood specie of the cabinet ordered. Supplied in 4 1/2" X 96" lengths at no charge per order. Extra toekick is available in 4 1/2" X 48" or 4 1/2" X 96" lengths.

Universal Toekick

1/2" PBC matching woodgrain laminate to match the wood specie of the cabinet ordered. Supplied in 8 1/2" X 96" lengths at no charge per order. Extra toekick is available in 8 1/2" X 48" or 8 1/2" X 96" lengths.

Plywood Toekick

1/2" plywood of the same wood specie as the cabinet ordered. Available in standard and universal toekick sizes.

Deluxe Touch Up Kit

Includes:
Premium Furniture Polish
Water Based Top Coat
(1) Stain Marker
(1) Stain Wax Pencil
Bumper Pads

Stain is available in pints, quarts, and gallons.

Internal Blower Exhaust System

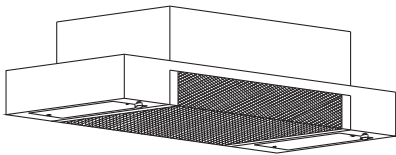

IBE

Twin squirrel cage blower mounted in control unit with 40 watt lights and washable aluminum mesh grease filter, 3 1/4" X 10" vertical or horizontal discharge, 350 CFM.