

# ELAN CATALOG UPDATE

Available April 2023



## CATALOG LAYOUT AND FORMAT

(Price and Spec on Same Page)

## ONE MODIFICATION SECTION

(Rather Than One Behind Each Section)

## SECTION FOR WOOD HOODS AND PANELS/FILLERS

### SPECIFY APPLIANCE CUTOUTS FOR NO CHARGE

**NEW DOOR STYLE:** Huntington

## DISCONTINUATIONS:

- Finish Traits – Dry Brushing, Fly Speck, Spatter
- Elan Braelyn Textured Foil
- Wood Trait #8 Wire Brushing

## WALL CABINETS:

- Arrange Pages like K+ (Heights are Grouped Together)

### E100-1, E100-4

- Add 33", 48", 54", 57", 60" Heights (All Widths)

### E100-5

- Add 33", 48", 54", 57", 60" Heights (All Widths)
- Add 12", 15", 18" Heights (All Widths)
- Add 45" and 48" Widths to 21" Height
- Add 48" Width to 24" Height

### E100-8

- Add 48", 54", 57", 60" Heights to Split Walls
- Add 37" Width to Fridge Walls
- Add 30", 33", 36" Heights to Fridge Walls
- Add 12", 15", 18" Heights to Double Door Fridge Walls

### E100-9

- Add Aventos HL (Out and Up, Lift Up Door) SKUS to Appliance Garage Options

### E100-12

- Add Wall 2 Drawer SKU (All Sizes)

### E100-13

- Discontinue Wall with Vegetable Bin (Whole Page)

## WALL CORNER CABINETS:

- Group Peninsula Cabinets Together like the K+ Catalog

### E200-1, E200-4, E200-5, E200-8, E200-9

- Add 33", 48", 54", 57", 60" Heights
  - Square Corner Walls
  - Blind Corner Walls
  - Diagonal Corner Walls
  - Diagonal Corner with Lazy Susan
- Add 48" Heights
  - Peninsula Blind Corner Walls
  - Peninsula Square Corner Walls
  - Peninsula Diagonal Corner Walls
  - Peninsula Diagonal Corner Split Walls

### E200-4, E200-8, E200-9

- Add 48", 54", 57", 60" Heights
  - Blind Corner Split Walls
  - Diagonal Corner Split Walls

## E200-12

- Add Aventos HL (Out and Up, Lift Up Door) SKUS to Appliance Garage Section

## WALL SPECIALTY CABINETS:

### E300-1

- Add 33", 48", 54", 57", 60" Heights to Wall Organizers

### E300-4

- Discontinue Wall with Plate Rack
- Discontinue Wall with Condiment Drawers

### E300-5

- Add 33" Height to Pull Out Spice Rack and Wall Spice Rack
- Discontinue Wall Pull Out Peg Board

### E300-7

- Wine Wall Storage Cube – Finished Exterior
- Add 54", 57", 60" Heights to Wine Wall Lattice
- Wine Wall Style X – Add 15", 18", 21", 24" Heights, 15", 18", 21", 24", 27" Widths
- Wine Wall Style X – Add Double X 30", 33", 36" Widths
- Discontinue Wine Wall Style B
- Discontinue Wall Plate Rack

### E300-9

- Add 12" Heights
- Add 18", 21" Widths
- Try to add 39" and 42" Widths

### E300-12

- Add Aventos HL (Out and Up, Lift Up Door) to Appliance Garage SKUS
- Add Door Options to Straight Appliance Garage SKUS (Tambour Walls)
- Discontinue Tip Out Bin

### E300-13

- Discontinue Wall End Shelves – Radius, Angled, Square
- Discontinue Fan Cabinet
- Add Wall End Shelf Radius with Square Top

### E300-16

- Add 33", 48", 54", 57", 60" Heights

### E300-17

- Adjust Price to Include Cut Out
- Add 33" Widths
- Add 33" and 48" Heights to Style A and Style B
- Add 54", 57", 60" Heights to Style C

### E300-20 (HOODS)

- Wood Hoods – New Section and Format

## WALL ACCESSORIES/MODIFICATIONS:

- Move Fillers and Panels to Own Sections
- Move Modifications to Own Section
- Move Any Accessories to End of Specialty Walls

### E400-1

- Discontinue Fluted Fillers

### E400-4

- Discontinue Fluted Fillers
- Add J-Filler with Panel

# ELAN CATALOG UPDATE

Available April 2023



## **E400-5**

- Discontinue End Panel (Beaded) and Peninsula Version

## **E400-8**

- Discontinue
  - Soffit Panel
  - Half Round Shelf
  - Under Cabinet Shelf
  - Under Cabinet Square Corner Shelf
- Add/Adjust Heights for Spice Rack Door
- Floating Shelves - Adjust Dimensions to 2-3/4" High x 12" Deep

## **E400-9**

- Decorative End Panel - Factory Installed
- Extended Side Down - Adjust Price to Include Finish Interior
- Discontinue Fluted End Wings

## **E400-12**

- Discontinue Extended End Wing with Angle

## **E400-13**

- Applied Valance Top Rail

## **BASE CABINETS:**

### **E500-5, E500-8**

- Add 39" and 42" Widths to all SKUS

## **BASE CORNER CABINETS:**

### **E600-1**

- Discontinue Blind Corner Base with Full Shelf Turn-Out Wire Shelf Version

### **E600-5**

- Discontinue Base Diagonal Corner with Wire Lazy Susan

### **E600-8**

- Discontinue Base Square Corner with Wire Lazy Susan
- Hinge Option D as Default
- Change Drawings to Doors with Hinge D Rather Than Two Doors

### **E600-9**

- Change Drawing on Square Corner Sing Base to have Hinge D

## **BASE SPECIALTY CABINETS:**

### **E700-1**

- Add Full Height Door SKUS - 15", 18", 21", 24" Widths

### **E700-4**

- Discontinue Base Pull Out Table

### **E700-5**

- Discontinue Base Cookware Organizers
- Discontinue Base with Tip Out Bins

### **E700-12**

- Microwave Bases - Include Cut Out in Price

### **E700-17**

- Discontinue Base Half Round

## **BASE ACCESSORIES/MODIFICATIONS:**

- Move Fillers and Panels to Own Sections
- Move Modifications to Own Section
- Move Any Accessories to End of Specialty Bases

### **E800-1**

- Discontinue Fluted Fillers

### **E800-4**

- Discontinue Fluted Fillers
- Add J-Filler with Panel

### **E800-5**

- Discontinue End Panel (Beaded) and Peninsula Version

### **E800-9**

- Drawer Front Bin - Change to plastic
- Discontinue Sliding Towel Bar Kit

### **E800-13**

- Remove White Laminate Roll Tray and Drawer Box Options

### **E800-16**

- Discontinue Fluted End Wings
- Discontinue Extended End Wing with Angle

## **TALL CABINETS:**

- Add 102", 108", 120" Height to all SKUS (Except Tall Pull Out Storage)

### **E900-1 - E900-5, E900-12**

- Add 102", 108", 120" Height all SKUS
- Add 39" and 42" Widths to all SKUS

### **E900-8**

- Add 27" and 33" Widths (Style C and D)

### **E900-13**

- Discontinue Tall Angled Corner
- Discontinue Tall Wine Storage Cube
- Discontinue Tall End Shelf

### **E900-16**

- Discontinue Curved Cabinets
- Discontinue Outside Corner Tall

### **E900-17, E900-20, E900-21, E900-24, E900-25**

- Add 36" Width to all SKUS
- Include Cut Out Charge in Price

### **E900-28 - E900-49**

- Closet Cabinets will have their Own Tab Section (Closet/Furniture)

## **TALL ACCESSORIES/MODIFICATIONS:**

### **E1000-1**

- Discontinue Fluted Fillers

### **E1000-4**

- Discontinue Fluted Fillers
- Add J-Filler with Panel

### **E1000-5**

- Discontinue End Panel (Beaded) and Peninsula version

### **E1000-8**

- Discontinue Extended End Wing with Angle

# ELAN CATALOG UPDATE

Available April 2023



## BATH CABINETS:

### E1100-5

- Add 48" Wide Vanity with 4 Drawers
- Add 3 Drawer SKUS and 6 Drawer SKUS
- Add Wall Mount SKUS

### E1100-12

- Add Vanity Outlet Drawer
- Add Vanity ht Waste Pull Out

### E1100-13

- Add 4 Drawer Bases

### E1100-16, E1100-17

- Add 90" and 96" Heights to Linen Cabinets

### E1100-20

- Add WCC Wall Cabinet with Open Shelf

### E1100-21

- Discontinue Fluted Fillers

### E1100-24

- Discontinue Fluted Fillers
- Add J-Filler with Panel

### E1100-25

- Discontinue Fluted End Wings
- Discontinue Extended End Wing with Angle

## MOULDINGS/MISCELLANEOUS:

### E1200-1

- Discontinue: CRM-C1/4 and CRM-T1/4 and DBM

### E1200-4

- Discontinue: CET-DB, CET-DR, CET-FR, CET-BE, CET-OC, BNM
- Change Countertop Edge Trim Round to SR Profile

### E1200-5

- Change CBSO11 name to Shoe Moulding
- Add Square Shoe Moulding (3/4" x 1/2")

### E1200-8

- Discontinue: BDM, BDM1/4, SDM, RM3/8, RM3/4, RM1 1/2, DM, UCTB

### E1200-9

- Add Starter Mouldings
- Foil Mouldings

### E1200-12

- Discontinue: T2M, P2M, S1M, S2M, Y2M

### E1200-13

- Discontinue: CR1111, CR1513, CR1512, CR1511

### E1200-16

- Discontinue: CR1611, CR1311
- Add 3-1/2" version of Style 16

### E1200-17

- Discontinue: FBM-GB, CAP
- Change FBM-C to SR Profile
- Names: OG (FBM-T), SR, OC (FBM-OC), OD (FBM-OD)

### E1200-24

- Discontinue 18" High SKUS
- Rename Arched Paneled Valance
- No Applied Mouldings

### E1200-25

- Discontinue: Scrolled, Victorian, and Baroque Valances
- Discontinue: Victorian Toekick Valance

### E1200-28

- Add Shiplap Panel
- Detail Drawing of Spacing on Grooved Panels

### E1200-29

- Discontinue Finished Shelf (Beaded)
- Add Dura Furniture Shelf and Shelf and Rail

### E1200-32

- Discontinue Style A and B
- Rename Style D to Wine Storage Frame

### E1200-33

- Discontinue Style A and B
- Change Pricing to Square Foot Pricing

### E1200-36

- Discontinue - Mirror
- Casters - Loose not Applied
- Plate Groove - Move to Mods

### E1200-37

- Discontinue: TPA01, TPA02, TPA04, TPA05, TPB01, TPB02, TPB04, TPB05

### E1200-40

- Discontinue: TPS01, TPS02, TPS04, TPS05, All TPR sizes

### E1200-44

- Discontinue: TPD01, TPD02, TPD04, TPD05, Architectural Posts with Fluting and Fluting/Corner Blocks
- Add Turned Post Styles (TPE 3", TPL 3 and 6, TPM 3 and 6, TPN 3 and 6)
- Add Architectural Posts with Wainscot Panel

### E1200-45

- Discontinue: WL-06, WL-17, ML-02, ML-06
- Add Black Finish Option to ML-05

### E1200-48

- Discontinue: MCA80, ACRE, TCRG, TCRF

## CLOSET/FURNITURE CABINETS:

- Closet Cabinets Move to Own Section
- Add Mudroom Cabinet SKUS

## ELAN CATALOG UPDATE

Available April 2023



### **MODIFICATIONS:**

- Add:
  - Increase Depth to 13" Mod
  - Increase Depth to 15" Mod
  - Grooved Flush Finished Side
  - Decorative End Panel (Now Factory Installed)
  - Two Finishes One Cabinet (Two Options)
  - Recessed Bottom (Different Process)
  - Omit Bottom Floor (Wall)
  - Toe Space Drawer
  - Convert Shelf to Shelf with Rail
  - Convert Shelf to Furniture Shelf





## TABLE OF CONTENTS

### **ELAN POLICIES/PROCEDURES .....P1-P6**

Delivery/Order Types .....P2

Defective Material.....P3

Warranty .....P5-P6



**PLACING AN ORDER**

Bertch Cabinet, LLC, accepts orders 24 hours a day via email or fax. Orders may be placed using the Bertch Kitchen+ order form or submitting the 2020 Design order form. You can print orders and fax to: **800-973-1200** or you can pdf orders and email to: **kitchen+@bertch.com**

For questions regarding placing an order, contact your sales representative or **Kitchen+ Dealer Services at 319-268-2592. Monday-Thursday 8:00am-5:00pm, Friday 8:00am-4:00pm Central time zone.**

**BERTCH KITCHEN+ ORDER FORM**

A fillable order form can be found on Bertch InfoNet, Kitchen+/Elan, Forms. It also can be found in the Forms tab in the catalog. Make sure the order form is as complete as possible when submitting, as to not delay the order entry process. Please include the floor plan, elevation drawings, Product Awareness Form, Appliance Specification Form, and Job Site Delivery Form with your order.

**2020 DESIGN ORDER FORM**

Submit the completed first page of the Bertch Kitchen+ order form along with the 2020 Design floor plan, elevations and order form. To find the 2020 Order Form go to: Presentation, Reports, Order Form. Set the sort order as Wall/Base/Tall and set Nomenclature as User Codes & Descriptions. This report contains the most detail, especially with modifications and dimension changes. Please include the floor plan, elevation drawings, Product Awareness Form, Appliance Specification Form, and Job Site Delivery Form with your order.

**STANDARD ORDERS**

For current lead times, reference InfoNet for up to the minute information. Go to: [www.bertch.com](http://www.bertch.com), For Pro's, (upper right corner) Dealer Log In. Standard orders will receive 2 days to look the order over for corrections/changes after the acknowledgment has been sent. Changes after 2 business days (M-F) will be subject to a change fee depending on the stage of production the order is in. Order Forms are located in the form section of the catalog or on the Bertch InfoNet.

**JOB COMPLETION ORDERS**

**Job Completion orders will not have the option of changes or cancellations due to their rush status.**

**Level 1: 20% Up-Charge**

Orders to complete an original order. To be eligible for **Level 1** the list price of the order can not exceed **\$1,159**. Lead time is approximately **9-13 calendar days** and shipped UPS at Dealer's expense or next available SCB truck if too large to ship UPS. Alternate Commercial Carrier arrangements may be made at Dealer's expense. Order forms are located in the Form section of the catalog or on the Bertch InfoNet.

**Level 2:** Orders to complete an original order. To be eligible for **Level 2** the list price of the order can not exceed **\$6,235**.

Lead time is approximately 3-4 weeks and shipped UPS at Dealer's expense or next available SCB truck if too large to ship UPS. Alternate Commercial Carrier arrangements may be made at Dealer's expense. Order forms are located in the Form section of the catalog or on the Bertch InfoNet.

**WARRANTY/REPLACEMENT ORDERS**

Orders for product due to a Bertch issue. Refer to Warranty for Details. (Located on page P5) Completed in **8 calendar days** and shipped UPS or next available SCB truck if too large to ship UPS. Alternate Commercial Carrier arrangements may be made at Dealer's expense. Replacement orders exceeding **\$935 list** require field inspection and authorization by a Bertch Sales Representative. Items in this category must be returned to Bertch for credit. Order forms are located in the Form section of the catalog or on the Bertch InfoNet.

**ORDER PROCESSING**

Bertch Cabinet, LLC, processes orders on a first in/first processed basis. If your order is not complete at the time of submission, this can delay the order entry process. Once we receive your order, we will send you a notification that your order has been received. If you do not receive this notification within 2 business days, consider that we did not receive the order and contact **Kitchen+ Dealer Services at 319-268-2592**.

Bertch Dealer Services strives to get your order acknowledgments back to you as soon as possible. Once you receive your order acknowledgment, you will have 2 business days (Monday-Friday) to review and make any no charge corrections or changes.

**ORDER CHANGES/CANCELLATIONS**

Order changes or cancellations are at the discretion of Bertch Cabinet, LLC. Charges for changes will be based on the stage of production at the time the change is requested. When you receive your acknowledgment, look at the bottom of your order and you will see a NCC Date (No Charge Change Date). This will be the date that you can make changes or corrections to the order without any additional charge. Changes after 2 business days (M-F) will be subject to a change fee depending on the stage of production the order is in. Amount of the charge will be dependent on where the order is in production. If the majority of an order is being changed before the NCC date, there may be an additional charge and/or the delivery date may be changed. If the order has been processed and then canceled there may be a **cancellation fee of \$489 list** whether the order has been acknowledged or not.

**DELIVERY**

All cabinets are cartoned for delivery. Shipments will be made on SCB trucks whenever possible, providing the delivery point is within our operating range. Common carrier or other methods may be used in unusual circumstances. It is the Dealer's responsibility to provide personnel to assist the driver in unloading cabinets from the truck. If a delivery of Bertch's combined product is less than six cabinets, there will be a \$180.00 list drop charge. If any order has less than six cabinets the \$180.00 will be added to the order and removed at invoicing if a combined total of six or more cabinets have been shipped. If a job site delivery is requested, our job site form must be filled out and sent in with order and map or instructions. **A job site delivery is \$950 list.**

**DEFECTIVE MATERIAL:****Doors:**

Doors that are warped 1/4" or less must be allowed to hang through one heating cycle before a no charge replacement will be considered. Some doors may warp slightly after installation (due to high or low humidity levels). The door will usually return to its normal flat position after going through the heating cycle. Please be certain the door is warped rather than the cabinet being racked out of square.

**Cabinets or Parts:**

Cabinets or parts that are defective will be replaced on a rush basis. Replacement orders exceeding \$935 list price require field inspection and signed authorization by our Bertch Sales Representative, and original cabinets or parts must be returned to Bertch for credit.

**Finish:**

Complaints concerning finish must be inspected by a field representative. Bertch reserves the option of approving a field repair or returning the cabinet or part to the factory for repair or replacement. No action may be taken without factory authorization. Exposure to smoke or extreme sunlight will alter the original appearance. Slight variations in grain and color are not considered defects, as this is the natural character and warmth of wood.

**PRICING DISCREPANCY**

Bertch Cabinet, LLC, strives to ensure that all pricing programs are accurate and identical. In the event a pricing discrepancy occurs between 2020 Design and the Kitchen+ catalog, use the current Kitchen+ catalog as the rule. **The Kitchen+ catalog supersedes all pricing programs.**

**RETURN POLICY**

Bertch Cabinet, LLC, products are manufactured specifically per customer request. Bertch does not accept returns due to customer errors or if the customer changes their mind. If your order is damaged or defective, please refer to those sections of the catalog or refer to our Bertch Cabinet, LLC. Limited Lifetime Warranty. In the case of a Return, the product needs to be cartoned using the original carton. A label and RGA paperwork will be mailed to you. Place the label on the outside of the carton and have the driver sign your RGA paperwork.

**PRODUCT IMPROVEMENTS**

Product modifications and improvements are part of the ongoing operating philosophy at Bertch. We reserve the right to improve/modify product at any time.



## LIMITED LIFETIME WARRANTY (Residential Purchaser)



Bertch Cabinet, LLC., (“**We**” or “**Us**”) extends the following limited lifetime warranty (“**Limited Warranty**”) to the first Residential Purchaser (“**You**” or “**Your**”) of a cabinet or cast polymer product manufactured by Us (each, a “**Product**”). This Limited Warranty is only applicable to Products sold to the first Residential Purchaser and used in the applications described below within the United States. Except as allowed below or by applicable law, You may not assign or transfer this Limited Warranty.

### **WHO IS A RESIDENTIAL PURCHASER?**

Under this Limited Warranty, a “**Residential Purchaser**” means any of the following:

- a person who purchases and installs the Product in a dwelling that is owned and used by that person as a primary or secondary home;
- any person or business such as a builder, contractor or developer that purchases and installs the Product in a newly constructed or remodeled dwelling that will be used by the initial owner/purchaser of that dwelling as a primary or secondary home. In such situation, this Limited Warranty may be assigned to the initial owner/purchaser who uses the dwelling as a primary or secondary home. Under this Limited Warranty, a primary or secondary home does not include rental property, or homes used for vacation rental properties, even on a part-time basis. (AirBNB, VRBO, etc.) This Limited Warranty does not apply to landlords, leasing companies or other commercial purchasers. (See Commercial Warranty)

### **WHAT DOES THIS LIMITED WARRANTY COVER?**

Subject to the exclusions and limitations set forth in this Limited Warranty, We warrant to You that each Product will be free from defects in material and workmanship, under normal use and maintenance, for the applicable warranty period stated below. This warranty gives You specific legal rights, and You may have other rights which vary from State to State.

### **WHAT IS THE WARRANTY PERIOD APPLICABLE TO RESIDENTIAL PURCHASERS?**

The warranty period for Your Product (excluding certain components discussed in the following paragraph) begins on the date the Product was purchased, whether purchased by You or by a third party on Your behalf. Your warranty is only valid if you use the dwelling as your primary or secondary home and does not extend to future owners if the property is sold.

Notwithstanding the preceding paragraph, the warranty periods applicable to the following Product components that were not originally manufactured by Us are as follows:

- Vent Hoods, Blowers, and components: 1 year from the date of original purchase
- Lighting, Electronic, and Powered components: 2 years from the date of original purchase.

### **DISCLAIMER OF OTHER WARRANTIES:**

THIS LIMITED WARRANTY IS OUR SOLE AND EXCLUSIVE WARRANTY WITH RESPECT TO THE PRODUCTS. ALL IMPLIED WARRANTIES ARE STRICTLY LIMITED TO THE DURATION OF THE LIMITED WARRANTY APPLICABLE TO THE PRODUCT AS STATED ABOVE, INCLUDING BUT NOT LIMITED TO, ANY WARRANTY OF MERCHANTABILITY OR OF FITNESS FOR A PARTICULAR PURPOSE.

### **WHAT THIS LIMITED WARRANTY DOES NOT COVER (EXCLUSIONS):**

The Limited Warranty does not apply to any Product:

1. installed or used outdoors;
2. used for purposes for which it is not designed or intended by Us;
3. which has been subjected to misuse, vandalism, abuse, negligence, accident, or unauthorized modifications;
4. which has been improperly stored (if the Product must be stored, it should be covered and stored in a humidity and temperature controlled environment, away from direct sunlight);
5. which has been improperly installed, cleaned, or maintained (for more information regarding the proper use and care of the Product, please consult the applicable Use and Care Instructions that accompanied the Product or that can be found at <https://www.bertch.com/support/cleaning-care/>);
6. which has been subjected to improper temperature, moisture and/or humidity extremes (temperature outside the range of 50-85°F (10-29°C) and humidity outside the range of 30-55% are considered extreme);
7. which has been subjected to direct contact with water for extended periods. (ie: Bath or Kitchen sink water not being wiped off when direct contact occurs)
8. damaged by fire, flood, acts of God, or other external causes beyond our control;
9. varying in color and characteristics due to age, sunlight, smoke, or other environmental conditions;
10. exhibiting any effects on the color and/or integrity of the finish or appearance due to the use of abrasive cleaners, cleaners that contain chlorine, acidic cleaners, scuffing sponges or steel wool; and/or
11. exhibiting normal wear and tear.

In addition, natural woods may vary in color and characteristics and exhibit subtle changes as they age. For example, painted doors, drawer fronts, and face frames will eventually have visible cracking around the joint area, and cabinet colors may darken or lighten over time. These variations are considered to be the nature of the material in relation to their environmental exposure and are not covered under this Limited Warranty.

**SOLE AND EXCLUSIVE REMEDY:**

In the event of a defect in the workmanship or materials of a Product or Product component occurring during the warranty period described above, We will, at our option, repair or replace any defective Product or Product component. If it is not commercially feasible to repair or replace a defective Product or Product component, We may refund the original price paid by You for the defective Product or Product component, or provide a credit towards a similar type of product sold by Us. The foregoing are Your sole and exclusive remedies for any Product defect or non-conformity. By way of example but not limitation, the following costs and expenses are not covered by this Limited Warranty: (1) labor costs for the original installation, removal, or re-installation of the Product, or defective part thereof; (2) labor costs or material charges for the removal, re-installation, repainting, refinishing or replacement of any other items or building materials which must be removed, replaced, reinstalled, or refinished in order to repair or replace the defective Product or component. For example, costs associated with the following will not be reimbursed: counters, sinks, tiles, flooring, accessories, appliances or plumbing fixtures. When a claim for warped components, joint separation or wood expansion or contraction is submitted, We may, at our option and after inspection, defer action for up to 12 months to allow the Product to acclimate to the installed environment. Further, We reserve the right to modify or alter any Product design, specifications or materials without obligation to make similar changes to Products previously manufactured or sold by Us.

The repair or replacement remedies offered by Us under this Limited Warranty are contingent on the current Product offerings of styles and construction options within our Product line at the time a warranty claim is made by You. If a valid warranty claim is filed for an obsolete Product, We reserve the right, at our sole option, to honor its repair or replacement obligations under this Limited Warranty by either: (1) replacing the affected Product or component with a new Product or component of the same or approximate style or color from our current Product line or offerings; or (2) replacing the affected Product or component to achieve a uniform appearance with a similar or comparable product style or approximate color of the originally purchased style. If a Product or components are replaced or repaired, We cannot guarantee an exact match with the finish or appearance of other products or fixtures installed at Your dwelling. This is due to changes that may occur during the Products' natural aging process, affecting its color and/or grain.

**LIMITATION OF LIABILITY:**

The remedies described above are Your sole and exclusive remedies and our entire liability for any breach of this Limited Warranty. Our total liability shall under no circumstances exceed the actual amount paid by You for the defective product. Further, We shall not under any circumstances be liable for any consequential, indirect, incidental, special or punitive damages or losses (including lost profits), even if this Limited Warranty is deemed to have failed of its essential purpose.

**HOW DO YOU OBTAIN WARRANTY SERVICE?**

This Limited Warranty can also be found online at [www.berth.com/support/warranty](http://www.berth.com/support/warranty) info. To obtain more information regarding the Product or to make a claim under this Limited Warranty, contact one of our authorized dealers or distributors, who will arrange for inspection of the Product. A dated sales receipt as proof of purchase is required to obtain benefits from this Limited Warranty. If you have difficulty obtaining assistance, please write to or e-mail to:

Bertch Cabinet, LLC./ Warranty  
P.O. Box 2280  
Waterloo, IA 50704  
[info@berth.com](mailto:info@berth.com)

---

**Warranty Timeline**

Cabinetry purchased from March 15, 2004 - Current: Lifetime Limited Warranty, As Stated Above

Cabinetry purchased prior to March 15, 2004, 10 year Warranty, now expired.





## TABLE OF CONTENTS

### **ELAN SPECIFICATIONS ..... S1-S8**

Casework..... S2 thru S4

Cabinet Interior Options.....S3

Drawer Box Options/Steel Tandem Box.....S4

Designing Information .....S6 thru S7



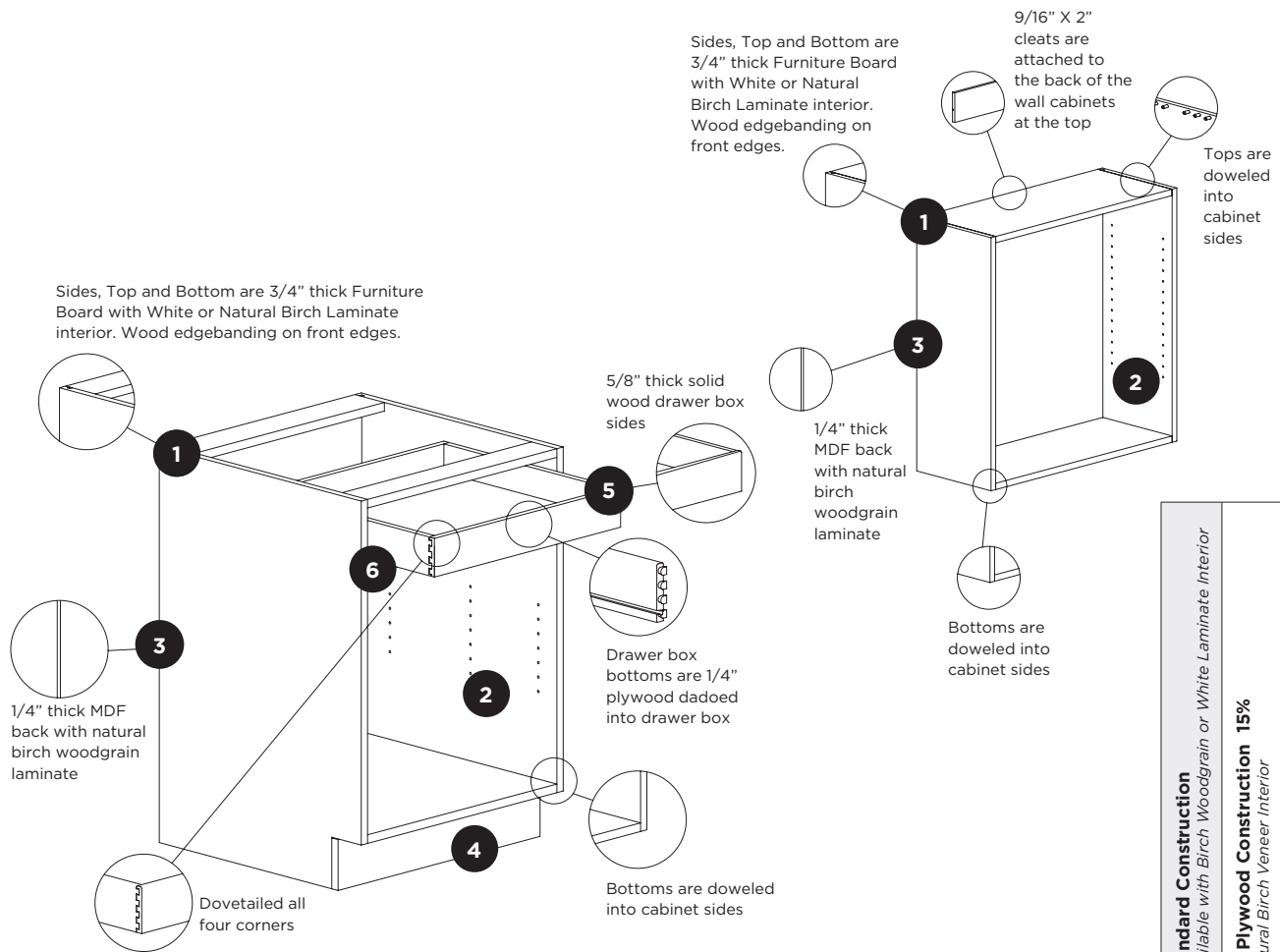

**Standard Construction**  
Available with Birch Woodgrain or White Laminate Interior

**All Plywood Construction 15%**  
Natural Birch Veneer Interior

<b>1. SIDES, TOPS &amp; BOTTOMS</b>		
3/4" thick Furniture Board with natural Birch woodgrain or white laminate interior.	<b>X</b>	
3/4" thick Plywood with natural Birch veneer interior.		<b>X</b>
<b>2. INTERIOR</b>		
Natural Birch woodgrain or white laminate.	<b>X</b>	
Natural Birch veneer.		<b>X</b>
Finished interior available in wood species and finish of exterior.	<b>X</b>	<b>X</b>
<b>3. BACKS</b>		
1/4" thick MDF with natural Birch woodgrain or white laminate.	<b>X</b>	
1/4" thick Plywood with natural Birch veneer.		<b>X</b>
<b>4. TOEKICK</b>		
4-1/2" high x 3-1/2" deep. 3/4" thick (8' lengths) Plywood toe board is included in wood species ordered.	<b>X</b>	<b>X</b>
<b>5. DRAWERS</b>		
5/8" thick, solid wood, dovetailed drawer box. Drawer bottom is 1/4" thick Plywood.	<b>X</b>	<b>X</b>
<b>6. GLIDES</b>		
Full extension, under mount, soft-motion, self-closing with easy release mechanism. Load rating of 75 lbs. 3 way adjustable	<b>X</b>	<b>X</b>
<b>EDGEBANDING</b>		
Front edges are banded with wood edgebanding, finished to match doors.	<b>X</b>	<b>X</b>
<b>SHELVES</b>		
3/4" thick Furniture Board with natural Birch woodgrain or white laminate. Edge banded on front edge.	<b>X</b>	
3/4" thick Plywood with natural Birch veneer. Edge banded on front edge.		<b>X</b>
<b>ROLLTRAYS</b>		
5/8" thick solid wood dovetailed drawer box. Drawer bottom is 1/4" thick Plywood.	<b>X</b>	<b>X</b>
<b>HINGES</b>		
Soft Close, Self-Closing Hinge	<b>X</b>	<b>X</b>



**STANDARD (FRAMELESS) CONSTRUCTION:**

- **Cabinet Sides** are 3/4" thick furniture board with wood edgebanding on the front edge.
- **Top and Bottom** are 3/4" thick furniture board, doweled to the sides, with wood edgebanding on the front edge.
- **Shelves** are 3/4" thick furniture board with PVC edge banding on front edge. Adjustable in 32mm increments.
- **Cabinet Interior** is a durable and smooth, natural birch woodgrain or white laminate unless a finished interior is specified.
- **Cabinet Back** is 1/4" thick MDF.
- **Toe Space** is 4-1/2" high x 3-1/2" deep. 8' lengths of finished plywood toe board are supplied and included.
- **Drawer Box and Roll Trays** are 5/8" thick solid wood, dovetailed at all four corners, sanded smooth and finished natural. Bottoms are 1/4" thick plywood, dadoed into the sides.
- **Drawer and Roll Tray Glides** are full extension, under mount glides with soft-close and self-close feature, with an easy release mechanism.
- **Hinges** are a soft-closing, self-closing concealed hinge.

**ALL PLYWOOD (FRAMELESS) CONSTRUCTION:**

- **Cabinet Sides** are 3/4" thick plywood with wood edgebanding on front edge.
- **Top and Bottom** are 3/4" thick plywood, doweled to the sides, with wood edgebanding on the front edge.
- **Shelves** are 3/4" thick plywood with wood edge banding on front edge. Adjustable in 32mm increments.
- **Cabinet Interior** is a durable and smooth, natural Birch Veneer unless a Finished Interior is specified.
- **Cabinet Back** is 1/4" thick plywood.
- **Toe Space** is 4-1/2" high x 3-1/2" deep. 8' lengths of finished plywood toe board are supplied and included.
- **Drawer Box and Roll Trays** are 5/8" thick solid wood, dovetailed at all four corners, sanded smooth and finished natural. Bottoms are 1/4" thick plywood, dadoed into the sides.
- **Drawer and Roll Tray Glides** are full extension, under mount glides with soft-close and self-close feature, with an easy release mechanism.
- **Hinges** are a soft-closing, self-closing concealed hinge.

STANDARD CONSTRUCTION .....	N/C
ALL PLYWOOD CONSTRUCTION .....	15%
PLYWOOD SHELVES (ONLY) .....	5%

**STANDARD HINGE:**

The standard hinge is the "clip" concealed hinge by Blum. The top hinge includes a soft close feature. This hinge features the very latest innovation in hinge technology. It has a 125 degree opening arc with 3-dimensional independent adjustment. (Degree of opening will vary on corner application.) The hinge baseplate is factory attached to the cabinet side. The "clip" hinge then snaps onto the mounting plate without the use of tools. Once the cabinet doors have been aligned to the proper position they can be removed and put back on the cabinet without further adjustment.

**ELAN BLUM CLIP HINGE**

Opening Angle: 110 Degrees

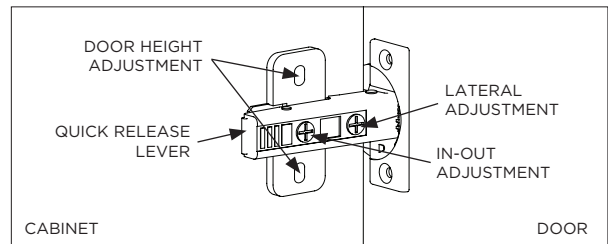

**STAIN FINISHES:**

Cabinets are hand-sanded before a penetrating grain stain is applied and hand-wiped. A catalyzed sealer, which is a blend of alkyd, amino and vinyl resins, is sprayed over the surface and oven-cured. The sealer penetrates the wood providing a "link" between the stain and the topcoat. The sealer is then sanded and prepared for the topcoat application. The final coating is a catalyzed, conversion varnish which is a carefully formulated combination of alkyd and amino resins. After spray application the topcoat is oven-cured to create an exceptionally smooth, clear and durable finish with superior moisture and chemical resistance.

**SOLID COLOR (PAINT) FINISHES:**

All cabinets and parts are filled and sanded before the first finish coat. Primer is a high solids, post catalyzed, acid cured finish with excellent adhesion, filling and sanding properties. The first primer coat is applied to penetrate the surface, then sanded smooth to prepare for the second primer coat. The second primer adds thickness and evens out the coverage. The final coating is a catalyzed, conversion varnish which is a carefully formulated combination of alkyd and amino resins. After spray application the topcoat is oven-cured to create an exceptionally smooth, clear and durable finish with superior moisture and chemical resistance.

**CABINET INTERIORS & CONSTRUCTION CHART**

DOOR STYLES	FURNITURE BOARD BIRCH WOOD GRAIN INTERIOR	FURNITURE BOARD WHITE INTERIOR	PLYWOOD BIRCH VENEER INTERIOR
Wood Door Styles	X	X	X
Foil Door Styles*	X		X
Laminate Door Styles	X	X	X

\* Foil door styles not available with white interior. (See page S4 for Foil Cabinetry special considerations.)

**SPECIAL WALL CABINET CONSIDERATIONS**

Any wall cabinet over 24" wide or 30" tall must be securely installed using one of the following options: Securing the cabinet between two cabinets; between a cabinet and a wall; supported from below; or attached through the frame into a soffit frame structure. Failure to properly secure wall cabinets will void the warranty.

**SPECIAL CONSIDERATIONS FOR FOIL DOOR STYLES**

- Foil door styles are not available with White cabinet interior option.
- Cabinets with Finished Ends or finished Interior are not available over 96" tall.
- For All Plywood Construction, any Finished part (i.e. Finished Ends, Finished Interior, etc.) will be built with Furniture Board. For example: An All Plywood Cabinet with a Finished End: the Finished End will be Furniture Board while the rest of the cabinet is Plywood. Another option is to use Overlay End Panels for a finished end application.
- Cabinets with specific solid wood components (hoods, wine racks, corbels, etc) are not available.

**HEAT SHIELD**

The use of heat shields is required with our foil products. Foil, although very durable, can be damaged by excessive heat. Heat shields are metal strips that deflect heat from the cabinetry and when properly installed, protect cabinets adjacent to ovens, ranges, and dishwashers. We also recommend opening doors and drawers away from the oven during high-temperature self-cleaning cycles. Also, pull countertop appliances, such as toasters, deep fryers or coffee makers, out from under the wall cabinetry before use. Damage caused by excessive heat is not covered by our warranty.

**DRAWER OPTIONS:**

**DOVETAIL DRAWER (STANDARD)**

Sides, front and back are 5/8" thick solid wood, dovetailed at all four corners. Drawer bottoms are 1/4" thick MDF core plywood. Drawer box is fastened to drawer front with screws. Drawer glides are full extension undermount, soft motion self closing with an easy release mechanism. They are lifetime guaranteed and have a load rating of 75 lbs. per pair. 3 way adjustable

**METAL TANDEM DRAWER (Add \$141 per drawer)**

Tandem box incorporates superior quality steel painted sides with soft rounded interior edges to allow easy cleaning and avoid dust build-up. The application possibilities include a standard drawer, an internal drawer and a pan drawer. The drawer front can be precisely adjusted vertically and horizontally. Incorporated into the steel sides are the unique full extension runner with unrivaled excellence in running action and side stability. The tandem runners glide quietly and are automatically pulled closed over the last stage of travel. The drawer bottom is a hefty 5/8" Furniture Board with a Low Pressure White Laminate.

**DRAWER OPTION PRICING**

Dovetail (Standard) .....	N/C
Tandem .....	\$141 per Drawer

**ROLLTRAY OPTIONS:**

**DOVETAIL ROLLTRAY (STANDARD)**

Sides, front and back are 2-7/16" high, 5/8" thick solid wood, dovetailed at all four corners. Rolltray bottoms are 1/4" thick MDF core plywood. Rolltray glides are full extension undermount, soft motion self closing with an easy release mechanism. They are lifetime guaranteed and have a load rating of 75 lbs. per pair.

**METAL TANDEM ROLLTRAY (Add \$141 per Drawer)**

Tandembox incorporates superior quality steel painted sides with soft rounded interior edges to allow easy cleaning and avoid dust build-up. The application possibilities include a standard drawer, an internal drawer and a pan drawer. The drawer front can be precisely adjusted vertically and horizontally. Incorporated into the steel sides are the unique full extension runner with unrivaled excellence in running action and side stability. The tandem runners glide quietly and are automatically pulled closed over the last stage of travel. The drawer bottom is a hefty 5/8" Particle Board Core with a Low Pressure White Laminate.

**ROLLTRAY OPTION PRICING**

Dovetail (Standard) .....	N/C
Tandem .....	\$141 per Drawer



**CLEARANCES**

Elan Cabinetry has very small casework reveals. The top and bottom reveal is  $\frac{3}{16}$ ". There is only  $\frac{3}{32}$ " from the edge of the door or drawer front to the outside of the case on the left and right sides. This is enough to allow your door and drawer to open if you are up tight against a wall. But is your drawer going to hit a door-way casing when you open it? Play it safe, trim out with a filler. When using blind corner cabinets plan 15" corners for your wall cabinets and 27" corners for your base cabinets. Order a 3" filler and trim on job site to 2-1/4" to take you out to the next 3" increment. Be prudent, use them. Leave them out and you may find yourself trying to pack 2 doors into a 1 door space.

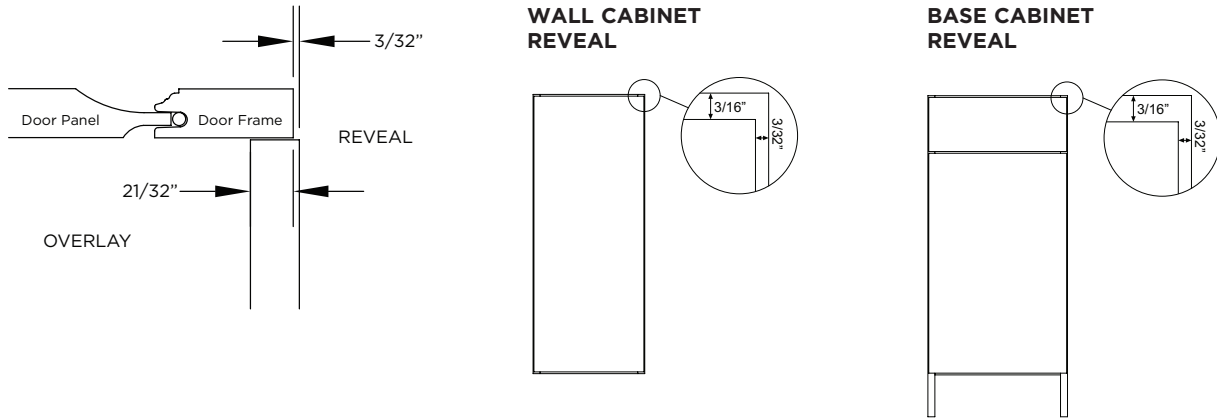

**BLIND CORNERS**

2-1/4" filler is needed (order a 3" filler and trim on site) to provide proper clearance and maintain 3" increments. BCW can be pulled 10"

**BLIND WALL**

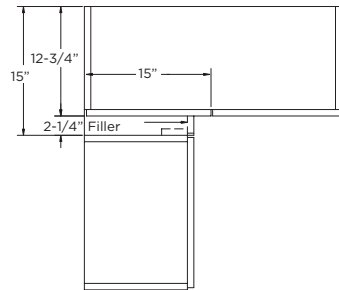

**BLIND BASE**

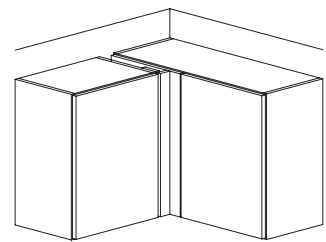
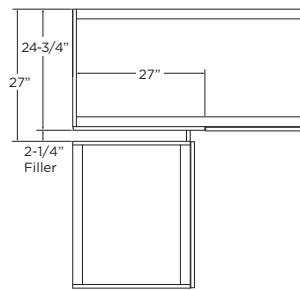

**SQUARE CORNER WALL**

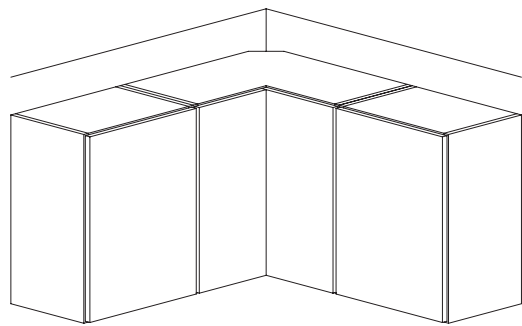
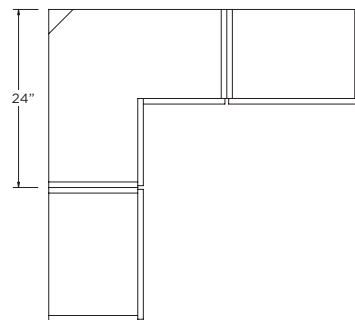

**DIAGONAL CORNER WALL**

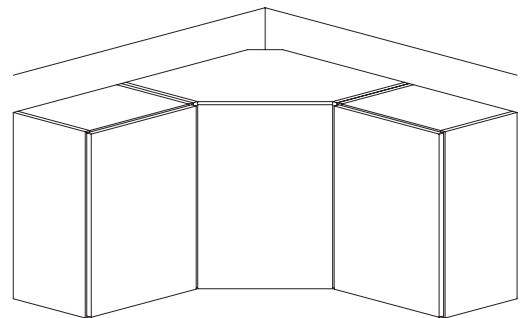
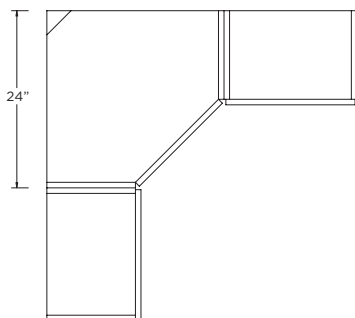

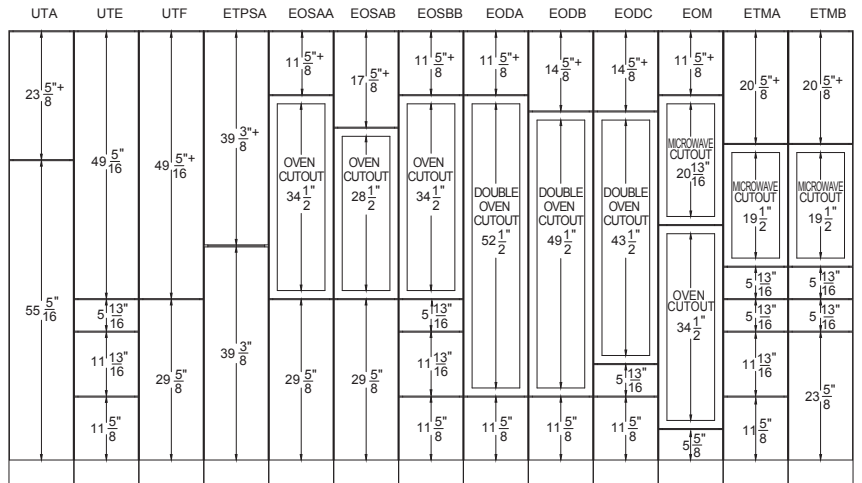
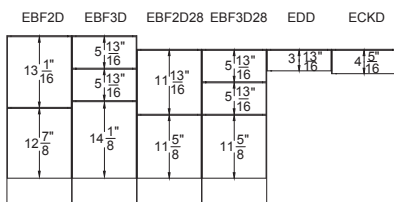
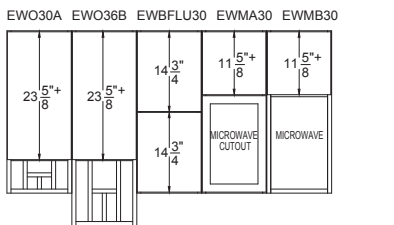
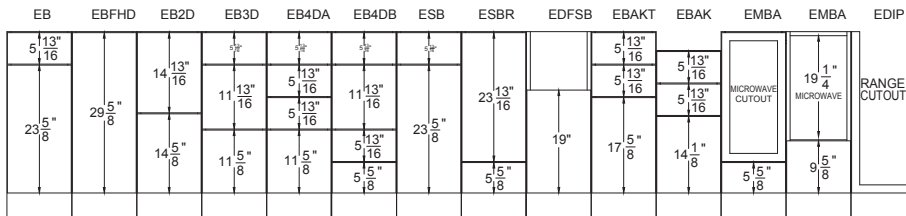
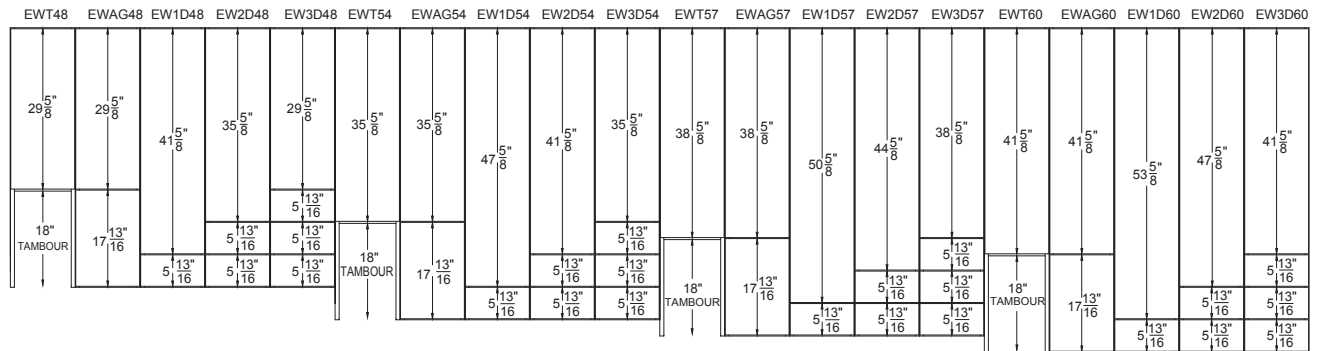
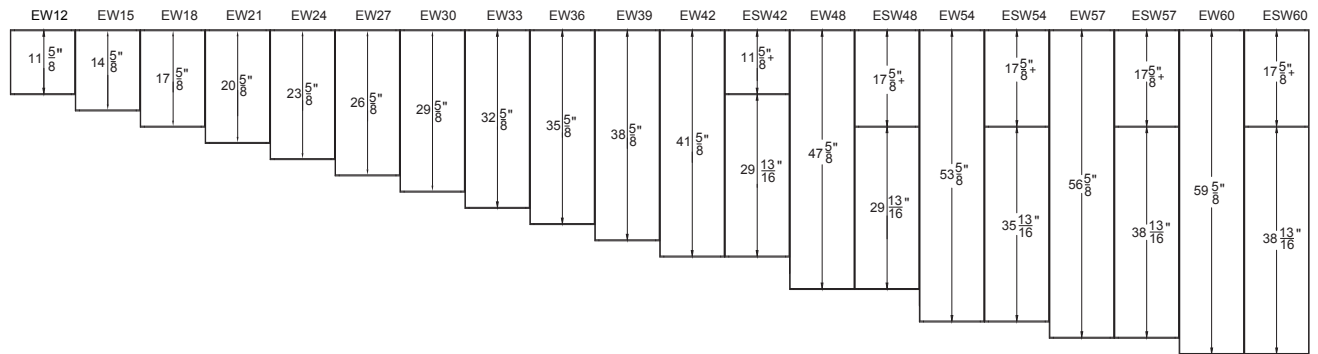

- Wall cabinets are shown at standard height. When height is changed, + indicates which section changes.
- Tall cabinets are shown at 84". For other heights (i.e. 90", 93", 96", 120") the upper section changes by amount of height increase. When height is changed, + indicates which section changes.





**TABLE OF CONTENTS**

**ELAN WOOD SPECIES/FINISHES..... W1-W7**

Wood/Finish Combinations.....	W2
Custom Color .....	W2 thru W3
Finishes/Stains/Solid Colors (Paint)/Sheen.....	W3
Foils/Laminate .....	W4
Glaze Colors/Applications .....	W5
Distressing/Wood Traits.....	W6
Wood Species .....	W7



WOOD SPECIES	BIRCH	ALDER SELECT ALDER **RUSTIC ALDER	CHERRY	HICKORY **RUSTIC HICKORY	MAPLE	1/4 SAWN RED OAK	RED OAK	WALNUT
<b>STAIN FINISHES</b>	BRINDLE	•		•				
	CANYON	•	•	•	•	•	•	•
	CHALET	•	•	•	•	•	•	
	CHINCHILLA	•		•	•	•		
	COFFEE BEAN	•		•		•		
	DAWN	•	•	•	•	•	•	•
	DRIFTWOOD	•	•	•	•	•	•	•
	FLAGSTONE	•	•	•				
	HARVEST	•	•					
	HONEY	•	•	•		•		
	INKWELL	•		•		•	•	
	KODIAK	•	•	•	•		•	•
	KONA	•		•				
	LODGE	•	•	•		•		
	MINERAL	•	•	•	•			
	MOCHA	•	•	•	•	•	•	•
	NATURAL	•	•	•	•	•	•	•
	RIVER ROCK	•	•	•	•	•	•	•
	SHALE	•	•	•	•	•	•	•
	SHORELINE	•	•	•	•		•	
SNOWBANK	•	•			•		•	
TOFFEE	•	•	•	•	•	•	•	

WOOD SPECIES	BIRCH MAPLE RED OAK
BLACK	•
CLOUD	•
COBALT	•
DUNE	•
EGGSHELL	•
GRAPHITE	•
GROVE	•
HARBOR	•
INDIGO	•
LIGHTHOUSE	•
LOFT	•
OLIVE	•
OYSTER BAY	•
POLAR	•
SAGE	•
SAILCLOTH	•
SMOKE	•
SNOWFLAKE	•
SPRUCE	•
WHITE	•

	BLACK GLAZE*	BROWN GLAZE*	GREY GLAZE*
STAIN FINISHES	•	•	•
SOLID COLOR (PAINT)	•	•	•

**FINISH UP-CHARGES:**

Stain Finishes	.0%
Specialty Stain	.4% (Chinchilla, Coffee Bean)
Solid Color (Paint)	.10%
Foil	.N/C
Laminate (HPL)	.Quote
Semi-Gloss or Matte Sheen	.N/C
Custom Stain Match	.2% + Set-Up Fee
Custom Paint Match	.15% + Set-Up Fee
Soft Glaze	.Add 10% to Stain or Paint Finish
Full Glaze	.Add 10% to Stain or Paint Finish
Brushed Glaze	.Add 15% to Stain or Paint Finish
Custom Glaze Color (Select Soft, Full or Brushed Application)	.Add 17%
Distressing & Finish Traits	.See Pages W4 and W5
Unfinished	.Deduct 5%

• Included in color chip set.

\* Glaze finishes are available with soft glaze, full glaze or brushed glaze. Specify glaze color and application (i.e. Black Brushed Glaze). A half door sample is required before ordering to see a finish sample.

\*\* All rustic woods need a Product Awareness Form. (Located in the forms section of the catalog.)

Go to [www.berth.com](http://www.berth.com) to see all combinations of woods and finishes.



**WIPING STAINS**



**UNFINISHED:** Painted/Stained 5% Credit

**CUSTOM WIPING STAIN:** Submit Custom Finish Match Order Form with finish sample to be matched. Add 2% plus one time fee of \$886. Additional lead time. APPROVED HALF DOOR SAMPLE REQUIRED.

Use assigned Custom Finish number when ordering. Custom finish sample is good for 9 months.

**SOLID COLORS (PAINT)**

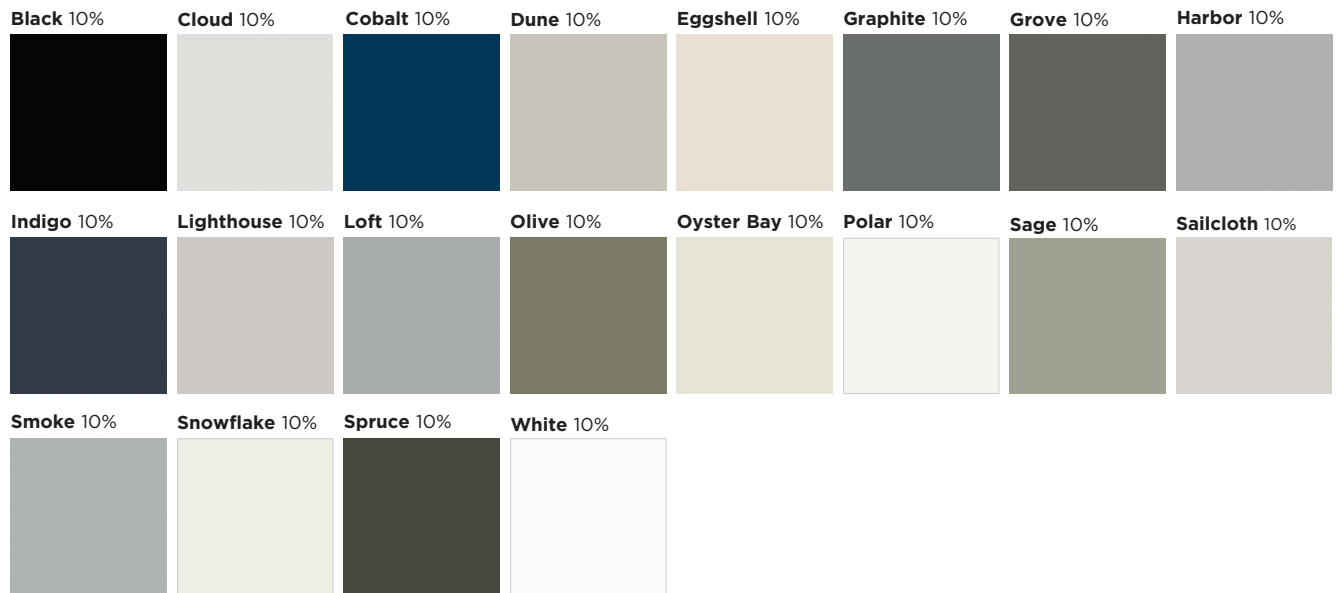

**CUSTOM SOLID COLOR:** Paint Match to Sherwin Williams or Benjamin Moore. Submit Custom Finish Match Order Form. 15% + One Time Set Up Fee \$886. Additional lead time. APPROVED COLOR CHIP REQUIRED.

Paint Match will be supplied on a color chip within 2 weeks. Assigned custom paint number, will be used when ordering. Color Sample is good for 9 months.

**FINISH SHEEN**

**Semi Gloss:** A medium luster that enhances the wood grain and color. .... 35°

**Matte:** A flat, no-gloss finish that creates a soft, rich appearance. .... 15°

Go to [www.berth.com](http://www.berth.com) to see all combinations of woods and finishes.

**FOILS**

Foil door styles have a matching back. Exception: Skye door back is white.

**TEXTURED: (FOR JOSS DOOR STYLE ONLY)**

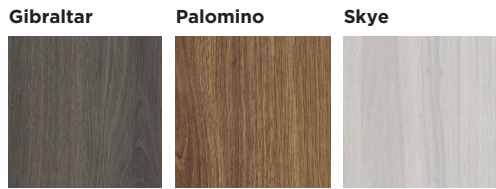

**SOLID:**

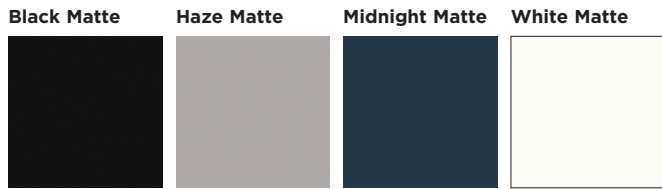

**HIGH GLOSS: (FOR JOSS DOOR STYLE ONLY)**

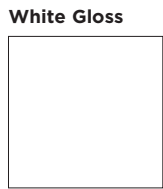

**LAMINATE**

**HIGH PRESSURE LAMINATES (For Solitaire Door Style Only)**

Wilsonart, Formica.....	<b>Call Factory For Pricing</b>
Nevamar, Interlam.....	<b>Call Factory For Pricing</b>
Pionite, Others.....	<b>Call Factory For Pricing</b>
Minimum HPL Order Upcharge:.....	\$703

Go to [www.berth.com](http://www.berth.com) to see all combinations of woods and finishes.

**GLAZE COLOR**



**Black**



**Brown**



**Grey**

**CUSTOM GLAZE COLOR:**  
 Add 17% plus one time fee of \$886. Specify Soft, Full or Brushed application. Additional lead time. **Approved door sample required.**

**GLAZE APPLICATION**



**Soft 10%**  
 Subtle glaze wiped-on profiles and edges.



**Full 10%**  
 All over even-toned wiped on glaze, profiles and edges accentuated.



**Brushed 15%**  
 All over wiped on Glaze with subtle brush strokes, less even toned, profiles and edges accentuated.

**BERTCH COLOR MATCH**

For Bertch Colors offered over 1 year old.

**STAIN** .....2% plus \$227 set-up fee

**SOLID COLOR**..... 12% plus \$227 set-up fee

*Color match will be provided on a half door for approval.*

*Color sample is good for 9 months.*

**CUSTOM FINISH**

Custom Stain, Custom Paint or Custom Multi-Step finish with sample provided for matching.

Color match will be provided on a half door for approval.

\$886 Set Up Fee + Additional Custom Up-Charge.

Submit Custom Finish Match Order Form.

*Assigned custom finish number, will be used when ordering.*

*Color sample is good for 9 months.*

Go to [www.bertch.com](http://www.bertch.com) to see all combinations of woods and finishes.



**#1 - NICKS & DENTS**  
Small, random nicks, dents and dings in the wood substrate.

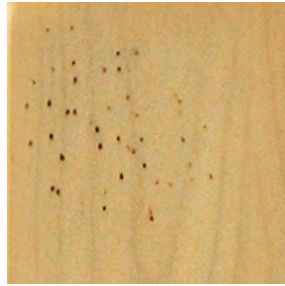

**#2 - BIRD PECKING**  
Small randomly grouped holes, simulation bird pecking.



**#3 - SCREWMARKS**  
Random screw impressions on the wood showing thread marks.



**#4 - WORN CORNERS (ADD 5%)**  
Profiles and corners are sanded down to remove the crisp new looking profiles.



**#5 - RASPING (ADD 5%)**  
Wood material is removed with a hand rasp to create a course, used appearance.



**#6 - RUBTHROUGH (ADD 10%)**  
Sanding through a layer of finish coating to expose another finish layer or wood substrate.

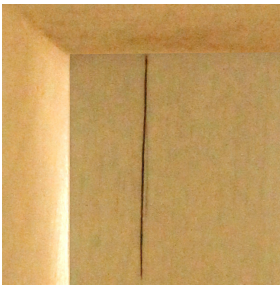

**#7 - CRACKS (ADD 10%)**  
Random, simulated cracks and splits.



**#9 - GOUGES (ADD 10%)**  
Large, deep area where the wood is removed (deeper and wider than "cracks").



**#10 - WORMHOLING (ADD 10%)**  
Closely grouped holes with beaten grain.

**PRICING:** Choose as many or as few wood traits as you want. The highest up-charge will apply once for all that is chosen.

**EXAMPLES:**

- Order for 1, 4 .....5% Up-charge
- Order for 1, 2, 3.....No Up-charge
- Order for 1, 4, 5.....5% Up-charge
- Order for 1, 4, 5, 6, 9,10.....10% Up-charge

*APPROVED DOOR SAMPLE REQUIRED*

*Go to [www.berth.com](http://www.berth.com) to see all combinations of woods and finishes.*





**ALDER (ADD 5%)**  
**RUSTIC ALDER**  
**SELECT ALDER (ADD 10%)**

A fine-grained hardwood similar to Cherry, Birch, and Maple. Pale yellow (tan) to reddish brown in color. A soft, light wood with even texture and straight grain that accepts stain well. Characteristics include random sized tight knots and rays.



**BIRCH**

White Birch, medium hardwood, similar to Maple but not as consistent in color as Maple, good base for solid color finishes, accepts stain unevenly; mottles. Mottling is a blotchy appearance evident due to various densities in the wood. Not recommended for darker stains. Off white color, medium density, fine texture, straight grain.



**CHERRY (ADD 15%)**

Darkens with age at a very fast rate, pitch marks (worm holes), mineral streaks, medium hardwood, accepts stain well. Cherry is especially sensitive to light. Light will cause the wood to darken/redden significantly. Medium reddish brown color, medium density, fine texture, straight grain. Sap wood of up to 20% is standard on any cherry component.



**HICKORY**  
**RUSTIC HICKORY (ADD 10%)**

A strong solid heavy wood with open grain that is known for its light to dark contrast in color. Cabinet components may range from a light, almost white, sapwood to a deep, reddish-brown color. The blend of light and dark wood is highlighted when finished in a natural or light stain; darker stains will mildly tone the color variations.

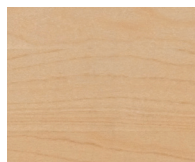

**MAPLE (ADD 8%)**

Hardwood, fine, tight grain, looks best with light, natural, or solid color finishes, yellows slightly with age. Not recommended for darker stains. Cream color, hard density, fine texture, straight grain.



**OAK (RED)**  
**QUARTER SAWN RED OAK (ADD 12%)**

Hardwood, open grain, accepts stain well, will darken slightly with age, grain pattern very evident when a solid color finish is applied. May vary in color from light to dark with possible shades of green.



**WALNUT (ADD 25%)**

Hardwood, dense, defined grain patterns, lightens with age and exposure to sunlight, best with a dark or natural finish. Dark brown color, medium hard density, medium texture, straight to irregular grain, premiere U.S. furniture wood.



**RUSTIC WOODS**

Solid wood will have character marks such as large knots and wane. Other characteristics include: small pin knots, bird pecks, worm tracks, mineral stain, irregular figures in the grain, cracks that do not hurt the strength of the part, sap wood and cherry pitch marks. Tri Views, Oval Mirror and Medicine Cabinet, Wood Tops, Frieze Valances, scribe and outside corner moulding will not be rustic. Rustic Hickory shown in photo.



**OTHER WOOD SPECIES**

Bertch will quote other wood species. Submit a quote request for pricing and availability. Additional lead time is required.

**WOOD SPECIES UP-CHARGES:**

Alder . . . . .	.5%	Quarter-Sawn Red Oak . . . . .	.12%
Birch . . . . .	.0%	Rustic Alder . . . . .	.0%
Cherry . . . . .	.15%	Rustic Hickory . . . . .	.10%
Hickory . . . . .	.0%	Select Alder . . . . .	.10%
Maple . . . . .	.8%	Walnut . . . . .	.25%
Oak (Red) . . . . .	.0%	Custom Species . . . . .	.Quote

Go to [www.bertch.com](http://www.bertch.com) to see all combinations of woods and finishes.





**TABLE OF CONTENTS**

**ELAN DOOR STYLES ..... D1 THRU D19**

Full Overlay Door Styles.....D2 thru D13  
Door & Drawer Front Option Pricing..... D14  
Door & Drawer Profile & Panel Reference..... D15  
Decorative Door Options..... D16  
Mullion Door Options ..... D17  
Leaded Glass Styles..... D18  
Glass Options/Pricing ..... D19

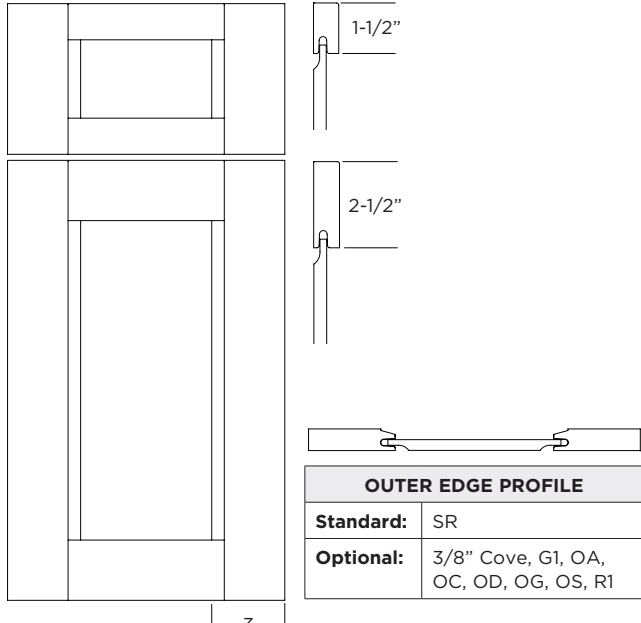
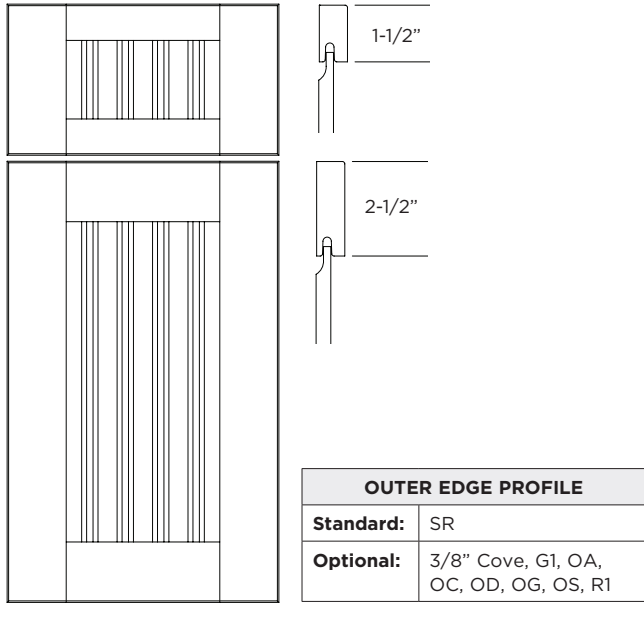
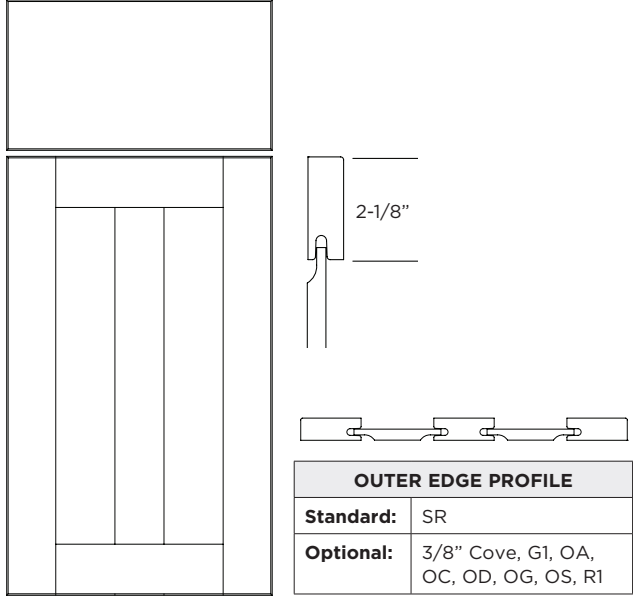
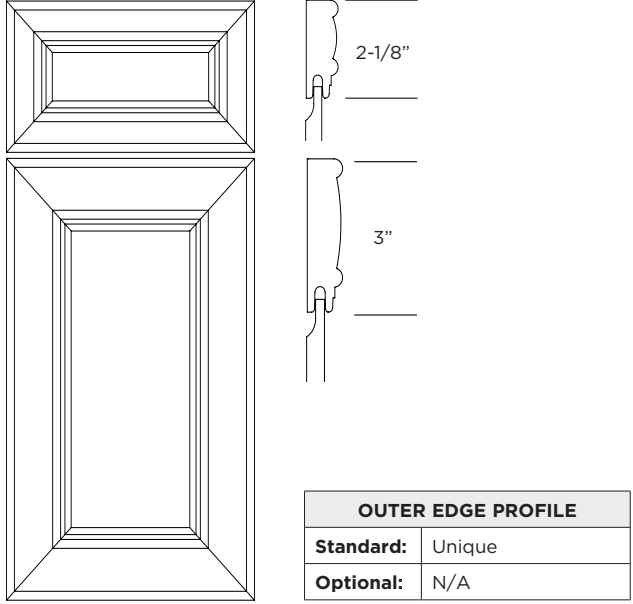

# ELAN DOOR STYLES

<b>ASHTON</b> FULL OVERLAY	PRICE CODE <b>C</b>	<b>BECKETT</b> FULL OVERLAY	PRICE CODE <b>D</b>												
 <table border="1" data-bbox="427 693 763 829"> <thead> <tr> <th colspan="2">OUTER EDGE PROFILE</th> </tr> </thead> <tbody> <tr> <td><b>Standard:</b></td> <td>SR</td> </tr> <tr> <td><b>Optional:</b></td> <td>3/8" Cove, G1, OA, OC, OD, OG, OS, R1</td> </tr> </tbody> </table>	OUTER EDGE PROFILE		<b>Standard:</b>	SR	<b>Optional:</b>	3/8" Cove, G1, OA, OC, OD, OG, OS, R1		 <table border="1" data-bbox="1109 693 1453 829"> <thead> <tr> <th colspan="2">OUTER EDGE PROFILE</th> </tr> </thead> <tbody> <tr> <td><b>Standard:</b></td> <td>SR</td> </tr> <tr> <td><b>Optional:</b></td> <td>3/8" Cove, G1, OA, OC, OD, OG, OS, R1</td> </tr> </tbody> </table>	OUTER EDGE PROFILE		<b>Standard:</b>	SR	<b>Optional:</b>	3/8" Cove, G1, OA, OC, OD, OG, OS, R1	
OUTER EDGE PROFILE															
<b>Standard:</b>	SR														
<b>Optional:</b>	3/8" Cove, G1, OA, OC, OD, OG, OS, R1														
OUTER EDGE PROFILE															
<b>Standard:</b>	SR														
<b>Optional:</b>	3/8" Cove, G1, OA, OC, OD, OG, OS, R1														
<p><b>DESIGN NOTES:</b></p> <ul style="list-style-type: none"> <li>• Drawer Fronts 4-3/4" high and less are Solid.</li> <li>• Doors over 48" in height will be constructed with a horizontal center rail and 2 equally sized panels.</li> <li>• Mullions not available.</li> </ul>		<p><b>DESIGN NOTES:</b></p> <ul style="list-style-type: none"> <li>• Drawer Fronts 4-3/4" high and less are Solid.</li> <li>• Doors over 48" in height will be constructed with a horizontal center rail and 2 equally sized panels.</li> </ul>													
<b>BRIDGEPORT</b> FULL OVERLAY	PRICE CODE <b>C</b>	<b>BRISTOL</b> FULL OVERLAY	PRICE CODE <b>E</b>												
 <table border="1" data-bbox="427 1648 763 1785"> <thead> <tr> <th colspan="2">OUTER EDGE PROFILE</th> </tr> </thead> <tbody> <tr> <td><b>Standard:</b></td> <td>SR</td> </tr> <tr> <td><b>Optional:</b></td> <td>3/8" Cove, G1, OA, OC, OD, OG, OS, R1</td> </tr> </tbody> </table>	OUTER EDGE PROFILE		<b>Standard:</b>	SR	<b>Optional:</b>	3/8" Cove, G1, OA, OC, OD, OG, OS, R1		 <table border="1" data-bbox="1125 1675 1453 1785"> <thead> <tr> <th colspan="2">OUTER EDGE PROFILE</th> </tr> </thead> <tbody> <tr> <td><b>Standard:</b></td> <td>Unique</td> </tr> <tr> <td><b>Optional:</b></td> <td>N/A</td> </tr> </tbody> </table>	OUTER EDGE PROFILE		<b>Standard:</b>	Unique	<b>Optional:</b>	N/A	
OUTER EDGE PROFILE															
<b>Standard:</b>	SR														
<b>Optional:</b>	3/8" Cove, G1, OA, OC, OD, OG, OS, R1														
OUTER EDGE PROFILE															
<b>Standard:</b>	Unique														
<b>Optional:</b>	N/A														
<p><b>DESIGN NOTE:</b></p> <ul style="list-style-type: none"> <li>• Double panel available on door widths 11-1/2" or over.</li> <li>• Doors over 48" in height will be constructed with a horizontal center rail and 4 equally sized panels.</li> </ul>		<p><b>DESIGN NOTE:</b></p> <ul style="list-style-type: none"> <li>• Drawer Fronts less than 5-1/2" high are Solid with R1 profile.</li> <li>• Doors over 48" in height will be constructed as 2 equally sized doors attached together.</li> </ul>													



**CAPELA**  
FULL OVERLAY **PRICE CODE F**

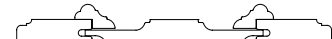
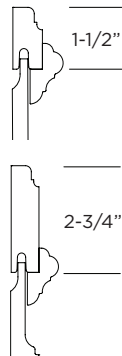
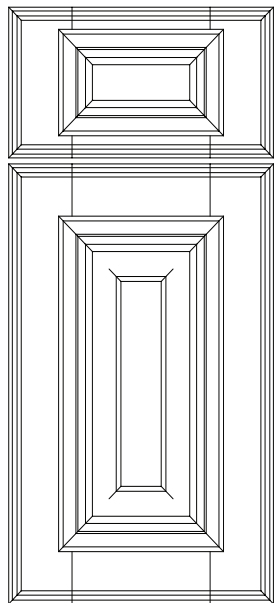

OUTER EDGE PROFILE	
<b>Standard:</b>	OC
<b>Optional:</b>	3/8" Cove, G1, OA, OD, OG, OS, R1, SR

**CLARKSON**  
FULL OVERLAY **PRICE CODE A**



**DRAWER FRONT:**  
Solid MDF, Solid Color (Paint) only.

**DOOR:**  
Solid MDF, Solid Color (Paint) only.

OUTER EDGE PROFILE	
<b>Standard:</b>	SR
<b>Optional:</b>	G1

**DESIGN NOTES:**

- A decorative molding creates an overall door thickness of 1-1/4".
- Drawer Fronts less than 5-1/2" high are Solid. Drawer Fronts 8" high and over have a raised panel.
- Doors over 48" in height will be constructed with a horizontal center rail and 2 equally sized panels.

**DESIGN NOTE:**

- Available for Solid Colors (Paint) only.

**CRAFTWOOD**  
FULL OVERLAY **PRICE CODE F**

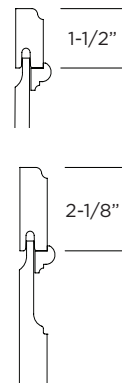
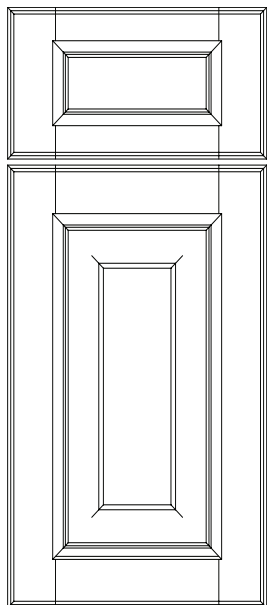

OUTER EDGE PROFILE	
<b>Standard:</b>	OD
<b>Optional:</b>	3/8" Cove, G1, OA, OC, OD, OG, OS, R1, SR

**DAWSON**  
FULL OVERLAY **PRICE CODE C**

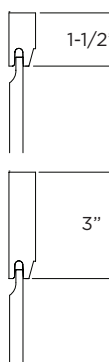
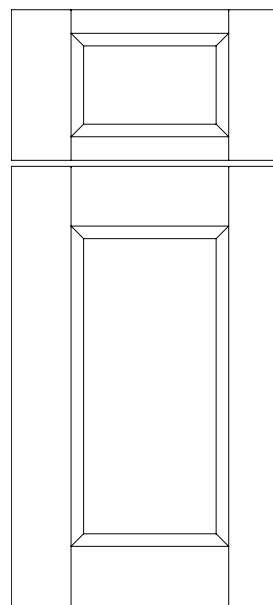

OUTER EDGE PROFILE	
<b>Standard:</b>	SR
<b>Optional:</b>	3/8" Cove, G1, OA, OC, OD, OG, OS, R1

**DESIGN NOTE:**

- A decorative molding is applied around panel perimeter on both door and Drawer Fronts.
- Drawer Fronts less than 5-1/2" high are Solid. Drawer Fronts 8" high and over have a raised panel.
- Doors over 48" in height will be constructed with a horizontal center rail and 2 equally sized panels.

**DESIGN NOTE:**

- Drawer Fronts 4-3/4" high and less are Solid.
- Doors over 48" in height will be constructed with a horizontal center rail and 2 equally sized panels.
- Mullions not available.

# ELAN DOOR STYLES

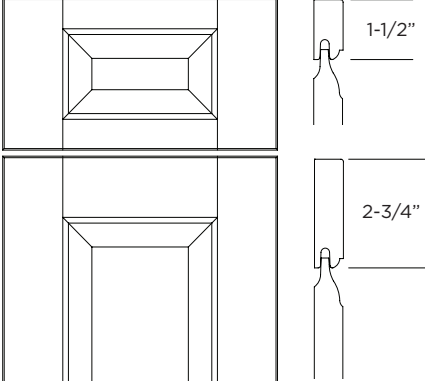
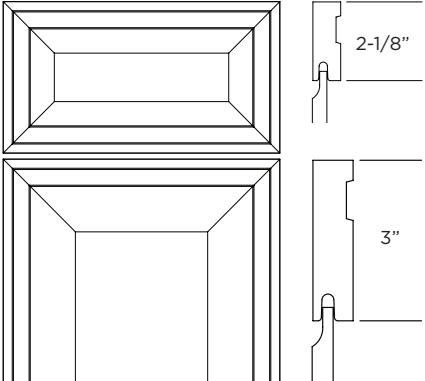
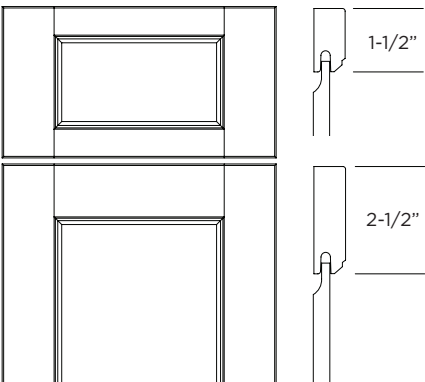
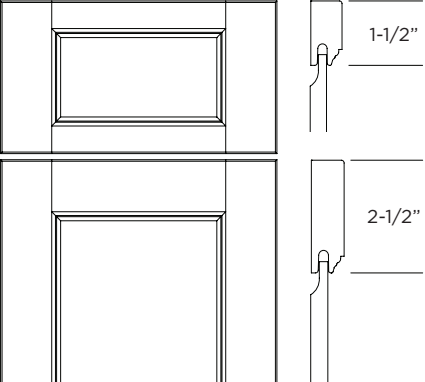
<h2>DELANEY</h2> <p>FULL OVERLAY</p>	<p>PRICE CODE <b>C</b></p>	<h2>DISTRICT</h2> <p>FULL OVERLAY</p>	<p>PRICE CODE <b>D</b></p>												
 <table border="1" data-bbox="428 695 763 829"> <thead> <tr> <th colspan="2">OUTER EDGE PROFILE</th> </tr> </thead> <tbody> <tr> <td><b>Standard:</b></td> <td>SR</td> </tr> <tr> <td><b>Optional:</b></td> <td>3/8" Cove, G1, OA, OC, OD, OG, OS, R1</td> </tr> </tbody> </table>	OUTER EDGE PROFILE		<b>Standard:</b>	SR	<b>Optional:</b>	3/8" Cove, G1, OA, OC, OD, OG, OS, R1		 <table border="1" data-bbox="1122 722 1456 829"> <thead> <tr> <th colspan="2">OUTER EDGE PROFILE</th> </tr> </thead> <tbody> <tr> <td><b>Standard:</b></td> <td>SR</td> </tr> <tr> <td><b>Optional:</b></td> <td>N/A</td> </tr> </tbody> </table>	OUTER EDGE PROFILE		<b>Standard:</b>	SR	<b>Optional:</b>	N/A	
OUTER EDGE PROFILE															
<b>Standard:</b>	SR														
<b>Optional:</b>	3/8" Cove, G1, OA, OC, OD, OG, OS, R1														
OUTER EDGE PROFILE															
<b>Standard:</b>	SR														
<b>Optional:</b>	N/A														
<p><b>DESIGN NOTE:</b></p> <ul style="list-style-type: none"> <li>• Drawer Fronts 4-3/4" high and less are Solid. Drawer Fronts less than 6-1/4" high to 4-3/4" are a flat panel. Drawer Fronts 6-1/4" high and over have a raised panel.</li> <li>• Doors over 48" in height will be constructed with a horizontal center rail and 2 equally sized panels.</li> </ul>		<p><b>DESIGN NOTE:</b></p> <ul style="list-style-type: none"> <li>• Drawer Fronts less than 5-1/2" high are Solid.</li> <li>• Doors over 48" in height will be constructed as 2 equally sized doors attached together.</li> </ul>													
<h2>EDGEWOOD</h2> <p>FULL OVERLAY</p>	<p>PRICE CODE <b>C</b></p>	<h2>EMERSON</h2> <p>FULL OVERLAY</p>	<p>PRICE CODE <b>C</b></p>												
 <table border="1" data-bbox="428 1650 763 1785"> <thead> <tr> <th colspan="2">OUTER EDGE PROFILE</th> </tr> </thead> <tbody> <tr> <td><b>Standard:</b></td> <td>SR</td> </tr> <tr> <td><b>Optional:</b></td> <td>3/8" Cove, G1, OA, OC, OD, OG, OS, R1</td> </tr> </tbody> </table>	OUTER EDGE PROFILE		<b>Standard:</b>	SR	<b>Optional:</b>	3/8" Cove, G1, OA, OC, OD, OG, OS, R1		 <table border="1" data-bbox="1122 1650 1456 1785"> <thead> <tr> <th colspan="2">OUTER EDGE PROFILE</th> </tr> </thead> <tbody> <tr> <td><b>Standard:</b></td> <td>SR</td> </tr> <tr> <td><b>Optional:</b></td> <td>3/8" Cove, G1, OA, OC, OD, OG, OS, R1</td> </tr> </tbody> </table>	OUTER EDGE PROFILE		<b>Standard:</b>	SR	<b>Optional:</b>	3/8" Cove, G1, OA, OC, OD, OG, OS, R1	
OUTER EDGE PROFILE															
<b>Standard:</b>	SR														
<b>Optional:</b>	3/8" Cove, G1, OA, OC, OD, OG, OS, R1														
OUTER EDGE PROFILE															
<b>Standard:</b>	SR														
<b>Optional:</b>	3/8" Cove, G1, OA, OC, OD, OG, OS, R1														
<p><b>DESIGN NOTE:</b></p> <ul style="list-style-type: none"> <li>• Drawer Fronts 4-3/4" high and less are Solid.</li> <li>• Doors over 48" in height will be constructed with a horizontal center rail and 2 equally sized panels.</li> </ul>		<p><b>DESIGN NOTE:</b></p> <ul style="list-style-type: none"> <li>• Drawer Fronts 4-3/4" high and less are Solid.</li> <li>• Doors over 48" in height will be constructed with a horizontal center rail and 2 equally sized panels.</li> </ul>													

**HUNTINGTON**  
FULL OVERLAY **PRICE CODE D**

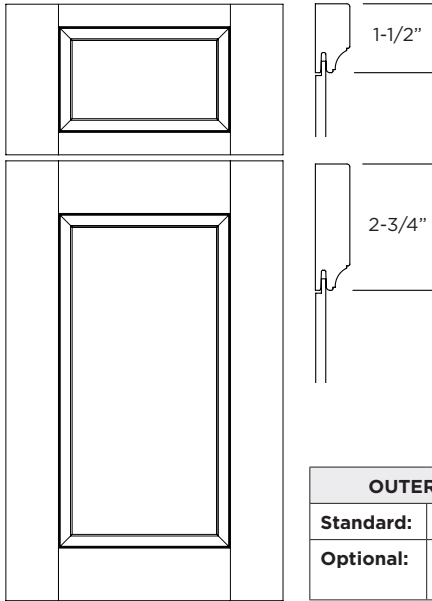

OUTER EDGE PROFILE	
<b>Standard:</b>	SR
<b>Optional:</b>	3/8" Cove, G1, OA, OC, OD, OG, OS, R1

**DESIGN NOTE:**

- Drawer Fronts 4-3/4" high and less are Solid.
- Doors over 48" in height will be constructed with a horizontal center rail and 2 equally sized panels.
- Center panel is plywood (or MDF for paint). Panel options are not available.
- Mullions not available.

**HUTTON**  
FULL OVERLAY **PRICE CODE C**

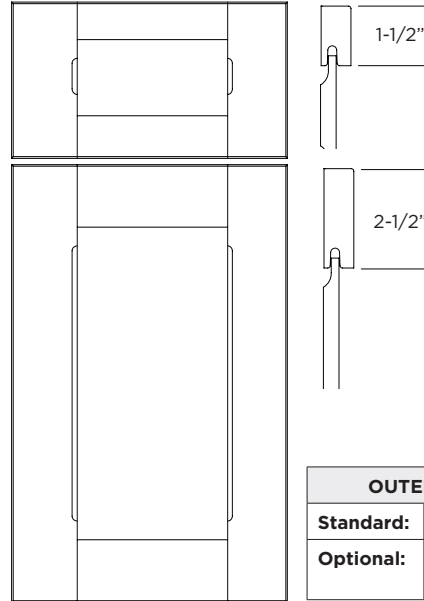

OUTER EDGE PROFILE	
<b>Standard:</b>	SR
<b>Optional:</b>	3/8" Cove, G1, OA, OC, OD, OG, OS, R1

**DESIGN NOTE:**

- Drawer Fronts less than 5-1/2" high are Solid.
- Doors over 48" in height will be constructed with a horizontal center rail and 2 equally sized panels.

**JOSS**  
FULL OVERLAY **PRICE CODE B**

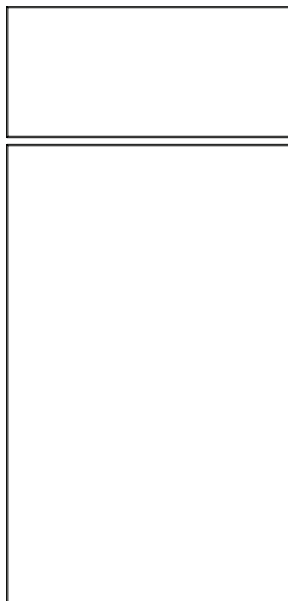

OUTER EDGE PROFILE	
<b>Standard:</b>	SR
<b>Optional:</b>	N/A

**DESIGN NOTE:**

- Available with Textured Foil, Matte Foil and Gloss Foil options.
- Back of door is matching. Exception: Skye door back is White.
- Maximum cabinet height with finished ends or finished interior is 96".

**KINGSTON 3**  
FULL OVERLAY **PRICE CODE G**

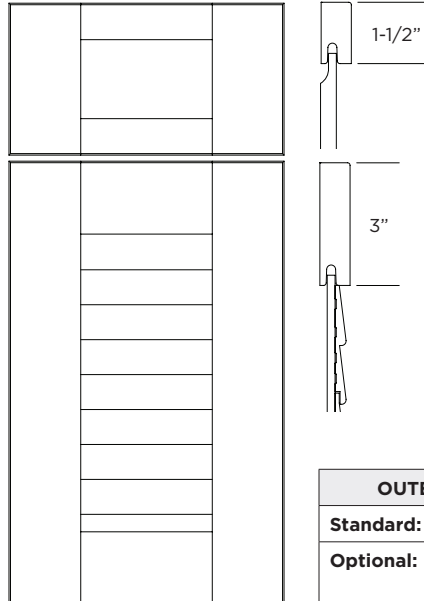

OUTER EDGE PROFILE	
<b>Standard:</b>	SR
<b>Optional:</b>	3/8" Cove, G1, OA, OC, OD, OG, OS, R1

**DESIGN NOTE:**

- Drawer Fronts 4-3/4" high and less are Solid.
- Doors over 48" in height will be constructed with a horizontal center rail and 2 equally sized panels.
- Not available in rustic woods.

# ELAN DOOR STYLES

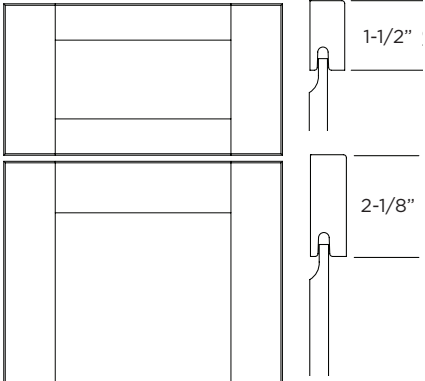
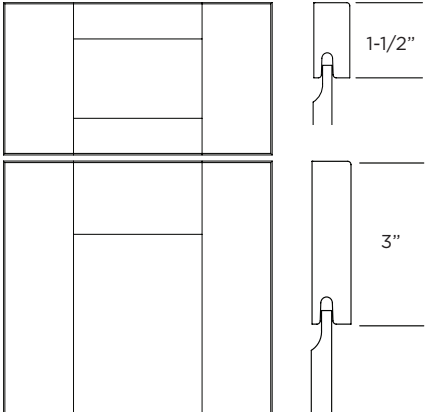
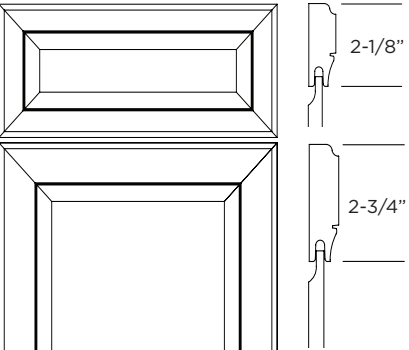
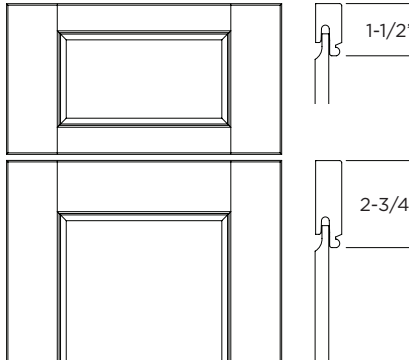
<h2>LEXINGTON</h2> <p>FULL OVERLAY</p>	<p>PRICE CODE <b>C</b></p>	<h2>LEXINGTON 3</h2> <p>FULL OVERLAY</p>	<p>PRICE CODE <b>D</b></p>												
 <table border="1" data-bbox="431 705 769 835"> <thead> <tr> <th colspan="2">OUTER EDGE PROFILE</th> </tr> </thead> <tbody> <tr> <td><b>Standard:</b></td> <td>SR</td> </tr> <tr> <td><b>Optional:</b></td> <td>3/8" Cove, G1, OA, OC, OD, OG, OS, R1</td> </tr> </tbody> </table>	OUTER EDGE PROFILE		<b>Standard:</b>	SR	<b>Optional:</b>	3/8" Cove, G1, OA, OC, OD, OG, OS, R1		 <table border="1" data-bbox="1114 705 1451 835"> <thead> <tr> <th colspan="2">OUTER EDGE PROFILE</th> </tr> </thead> <tbody> <tr> <td><b>Standard:</b></td> <td>SR</td> </tr> <tr> <td><b>Optional:</b></td> <td>3/8" Cove, G1, OA, OC, OD, OG, OS, R1</td> </tr> </tbody> </table>	OUTER EDGE PROFILE		<b>Standard:</b>	SR	<b>Optional:</b>	3/8" Cove, G1, OA, OC, OD, OG, OS, R1	
OUTER EDGE PROFILE															
<b>Standard:</b>	SR														
<b>Optional:</b>	3/8" Cove, G1, OA, OC, OD, OG, OS, R1														
OUTER EDGE PROFILE															
<b>Standard:</b>	SR														
<b>Optional:</b>	3/8" Cove, G1, OA, OC, OD, OG, OS, R1														
<p><b>DESIGN NOTE:</b></p> <ul style="list-style-type: none"> <li>• Drawer Fronts 4-3/4" high and less are Solid.</li> <li>• Doors over 48" in height will be constructed with a horizontal center rail and 2 equally sized panels.</li> </ul>		<p><b>DESIGN NOTE:</b></p> <ul style="list-style-type: none"> <li>• Drawer Fronts 4-3/4" high and less are Solid.</li> <li>• Doors over 48" in height will be constructed with a horizontal center rail and 2 equally sized panels.</li> </ul>													
<h2>MARCUS</h2> <p>FULL OVERLAY</p>	<p>PRICE CODE <b>D</b></p>	<h2>MONTEREY</h2> <p>FULL OVERLAY</p>	<p>PRICE CODE <b>C</b></p>												
 <table border="1" data-bbox="431 1682 756 1791"> <thead> <tr> <th colspan="2">OUTER EDGE PROFILE</th> </tr> </thead> <tbody> <tr> <td><b>Standard:</b></td> <td>OD</td> </tr> <tr> <td><b>Optional:</b></td> <td>N/A</td> </tr> </tbody> </table>	OUTER EDGE PROFILE		<b>Standard:</b>	OD	<b>Optional:</b>	N/A		 <table border="1" data-bbox="1114 1654 1455 1785"> <thead> <tr> <th colspan="2">OUTER EDGE PROFILE</th> </tr> </thead> <tbody> <tr> <td><b>Standard:</b></td> <td>SR</td> </tr> <tr> <td><b>Optional:</b></td> <td>3/8" Cove, G1, OA, OC, OD, OG, OS, R1</td> </tr> </tbody> </table>	OUTER EDGE PROFILE		<b>Standard:</b>	SR	<b>Optional:</b>	3/8" Cove, G1, OA, OC, OD, OG, OS, R1	
OUTER EDGE PROFILE															
<b>Standard:</b>	OD														
<b>Optional:</b>	N/A														
OUTER EDGE PROFILE															
<b>Standard:</b>	SR														
<b>Optional:</b>	3/8" Cove, G1, OA, OC, OD, OG, OS, R1														
<p><b>DESIGN NOTE:</b></p> <ul style="list-style-type: none"> <li>• Drawer Fronts less than 5-1/2" high are Solid.</li> <li>• Doors over 48" in height will be constructed as 2 equally sized doors attached together.</li> <li>• Mullions not available.</li> </ul>		<p><b>DESIGN NOTE:</b></p> <ul style="list-style-type: none"> <li>• Drawer Fronts 4-3/4" high and less are Solid.</li> <li>• Doors over 48" in height will be constructed with a horizontal center rail and 2 equally sized panels.</li> </ul>													

**NORTHBROOK**  
FULL OVERLAY

PRICE CODE **C**

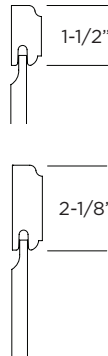
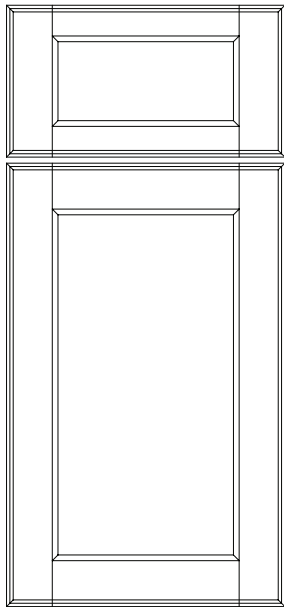

OUTER EDGE PROFILE	
Standard:	OD
Optional:	3/8" Cove, G1, OA, OC, OG, OS, R1, SR

**ODESSA**  
FULL OVERLAY

PRICE CODE **B**

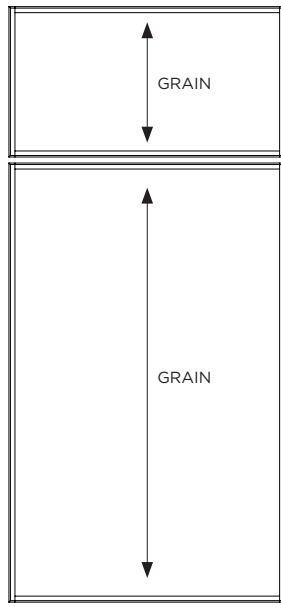

**DRAWER FRONT:**  
Veneered drawer front. Banded 4 sides with 1/4" Solid wood. Vertical grain, non grain matched between door and drawer front.

**DOOR:**  
Veneered door. Banded 4 sides with 1/4" Solid wood. Vertical grain, non grain matched between door and drawer front.



OUTER EDGE PROFILE	
Standard:	SR
Optional:	N/A

**DESIGN NOTE:**

- Drawer Fronts 4-3/4" high and less are Solid.
- Doors over 48" in height will be constructed with a horizontal center rail and 2 equally sized panels.

**DESIGN NOTE:**

- Not available with Solid Color (Paint).
- Not available in Rustic Wood Species.

**OXFORD 3**  
FULL OVERLAY

PRICE CODE **C**

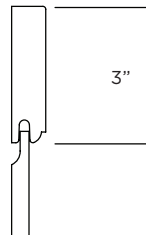
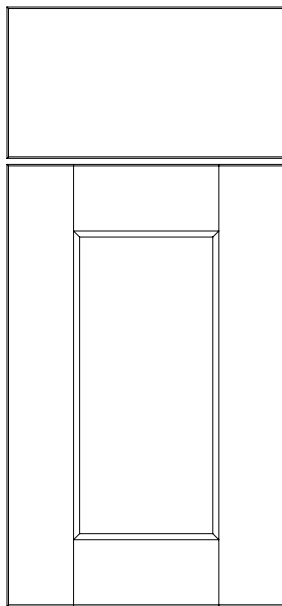

OUTER EDGE PROFILE	
Standard:	SR
Optional:	3/8" Cove, G1, OA, OC, OD, OG, OS, R1

**PALERMO**  
FULL OVERLAY

PRICE CODE **C**

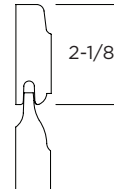
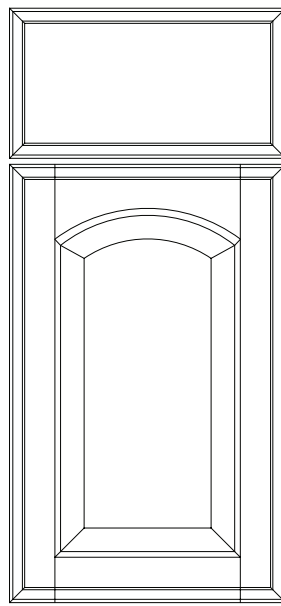

OUTER EDGE PROFILE	
Standard:	OG
Optional:	3/8" Cove, G1, OA, OC, OD, OS, R1, SR

**DESIGN NOTE:**

- Doors over 48" in height will be constructed with a horizontal center rail and 2 equally sized panels.

**DESIGN NOTE:**

- Doors over 48" in height will be constructed with a horizontal center rail and 2 equally sized panels.
- Doors 6-1/2" to 11-1/2" wide will have a modified arch.
- This door style compliments Villager.

# ELAN DOOR STYLES

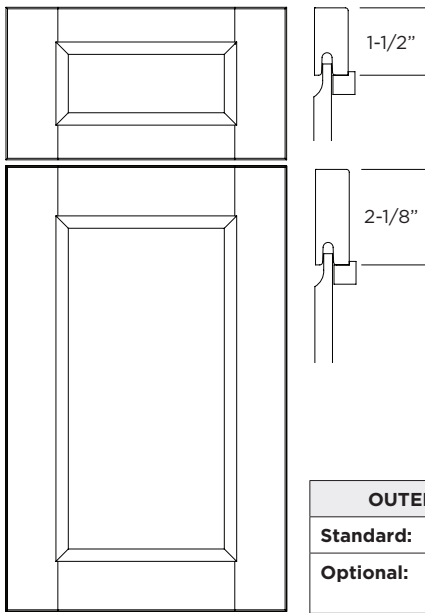
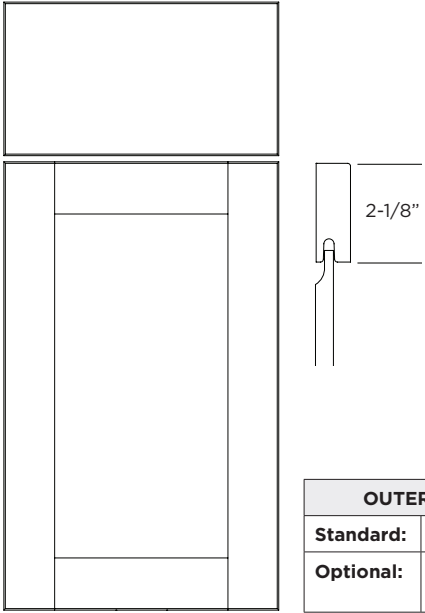
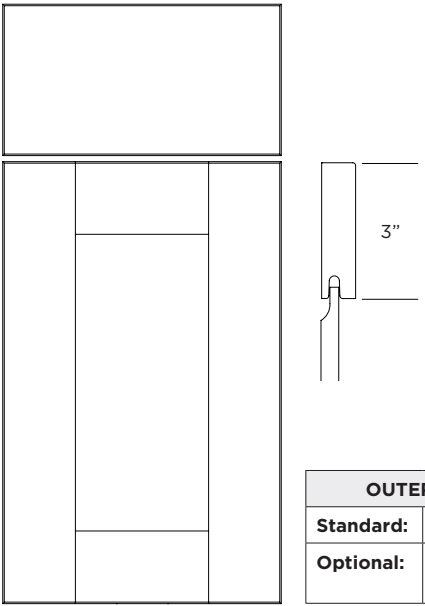
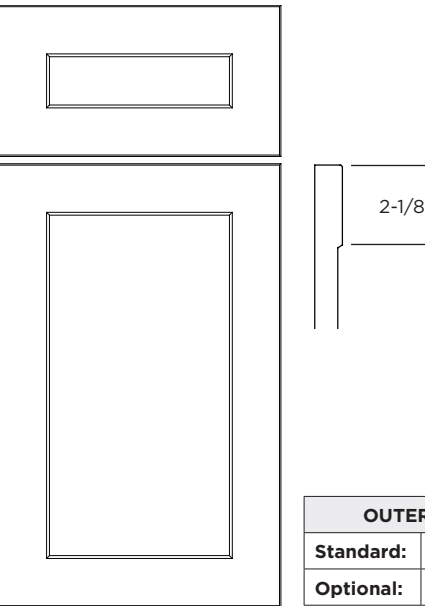
<h2>PORTLAND</h2> <p>FULL OVERLAY</p>	<p>PRICE CODE <b>F</b></p>	<h2>QUINCY</h2> <p>FULL OVERLAY</p>	<p>PRICE CODE <b>B</b></p>												
 <table border="1" data-bbox="431 701 768 835"> <thead> <tr> <th colspan="2">OUTER EDGE PROFILE</th> </tr> </thead> <tbody> <tr> <td>Standard:</td> <td>SR</td> </tr> <tr> <td>Optional:</td> <td>3/8" Cove, G1, OA, OC, OD, OG, OS, R1</td> </tr> </tbody> </table>	OUTER EDGE PROFILE		Standard:	SR	Optional:	3/8" Cove, G1, OA, OC, OD, OG, OS, R1		 <table border="1" data-bbox="1118 701 1455 835"> <thead> <tr> <th colspan="2">OUTER EDGE PROFILE</th> </tr> </thead> <tbody> <tr> <td>Standard:</td> <td>SR</td> </tr> <tr> <td>Optional:</td> <td>3/8" Cove, G1, OA, OC, OD, OG, OS, R1</td> </tr> </tbody> </table>	OUTER EDGE PROFILE		Standard:	SR	Optional:	3/8" Cove, G1, OA, OC, OD, OG, OS, R1	
OUTER EDGE PROFILE															
Standard:	SR														
Optional:	3/8" Cove, G1, OA, OC, OD, OG, OS, R1														
OUTER EDGE PROFILE															
Standard:	SR														
Optional:	3/8" Cove, G1, OA, OC, OD, OG, OS, R1														
<p><b>DESIGN NOTE:</b></p> <ul style="list-style-type: none"> <li>• A decorative molding is applied around panel perimeter on both door and drawer fronts.</li> <li>• Drawer Fronts less than 5-1/2" high are Solid.</li> <li>• Doors over 48" in height will be constructed with a horizontal center rail and 2 equally sized panels.</li> </ul>		<p><b>DESIGN NOTE:</b></p> <ul style="list-style-type: none"> <li>• Doors over 48" in height will be constructed with a horizontal center rail and 2 equally sized panels.</li> </ul>													
<h2>QUINCY 3</h2> <p>FULL OVERLAY</p>	<p>PRICE CODE <b>C</b></p>	<h2>RIDLEY</h2> <p>FULL OVERLAY</p>	<p>PRICE CODE <b>B</b></p>												
 <table border="1" data-bbox="431 1652 768 1787"> <thead> <tr> <th colspan="2">OUTER EDGE PROFILE</th> </tr> </thead> <tbody> <tr> <td>Standard:</td> <td>SR</td> </tr> <tr> <td>Optional:</td> <td>3/8" Cove, G1, OA, OC, OD, OG, OS, R1</td> </tr> </tbody> </table>	OUTER EDGE PROFILE		Standard:	SR	Optional:	3/8" Cove, G1, OA, OC, OD, OG, OS, R1		 <table border="1" data-bbox="1118 1677 1455 1787"> <thead> <tr> <th colspan="2">OUTER EDGE PROFILE</th> </tr> </thead> <tbody> <tr> <td>Standard:</td> <td>SR</td> </tr> <tr> <td>Optional:</td> <td>N/A</td> </tr> </tbody> </table>	OUTER EDGE PROFILE		Standard:	SR	Optional:	N/A	
OUTER EDGE PROFILE															
Standard:	SR														
Optional:	3/8" Cove, G1, OA, OC, OD, OG, OS, R1														
OUTER EDGE PROFILE															
Standard:	SR														
Optional:	N/A														
<p><b>DESIGN NOTE:</b></p> <ul style="list-style-type: none"> <li>• Doors over 48" in height will be constructed with a horizontal center rail and equally sized panels.</li> </ul>		<p><b>DESIGN NOTE:</b></p> <ul style="list-style-type: none"> <li>• Available with Matte Foil only.</li> <li>• Back of door is a matching or complimentary foil.</li> <li>• Maximum cabinet height with finished interior or finished ends is 96".</li> </ul>													

**RIVERSIDE**  
FULL OVERLAY

PRICE CODE **C**

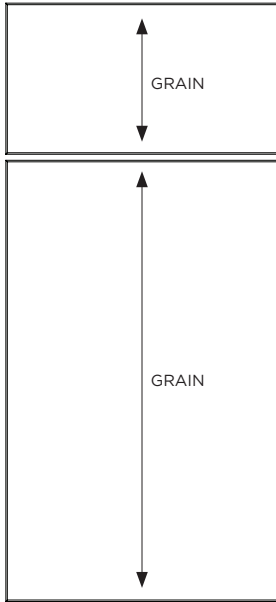

**DRAWER FRONT:**  
Veneered drawer front. Wood edge banding. Vertical grain, non grain matched between door and drawer front.

**DOOR:**  
Veneered door. Wood edge banding. Vertical grain, non grain matched between door and drawer front.

OUTER EDGE PROFILE	
<b>Standard:</b>	SR
<b>Optional:</b>	N/A

**ROYALE**  
FULL OVERLAY

PRICE CODE **B**

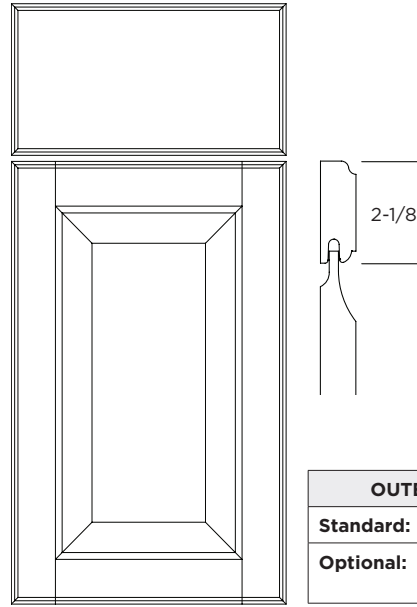

OUTER EDGE PROFILE	
<b>Standard:</b>	OD
<b>Optional:</b>	3/8" Cove, G1, OA, OC, OG, OS, R1, SR

**DESIGN NOTE:**

- Not available with Solid Color (Paint), except for Oak. For Paint Finishes, order Clarkson door style.
- Not available with Rustic woods.

**DESIGN NOTE:**

- Doors over 48" in height will be constructed with a horizontal center rail and 2 equally sized panels.

**SAWYER**  
FULL OVERLAY

PRICE CODE **C**

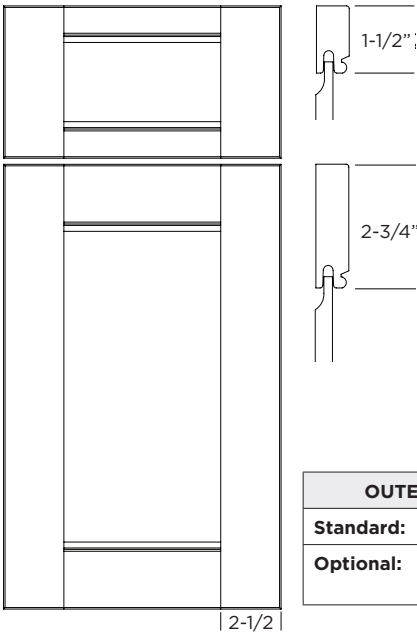

OUTER EDGE PROFILE	
<b>Standard:</b>	SR
<b>Optional:</b>	3/8" Cove, G1, OA, OC, OD, OG, OS, R1

2-1/2

**SEVILLE**  
FULL OVERLAY

PRICE CODE **D**

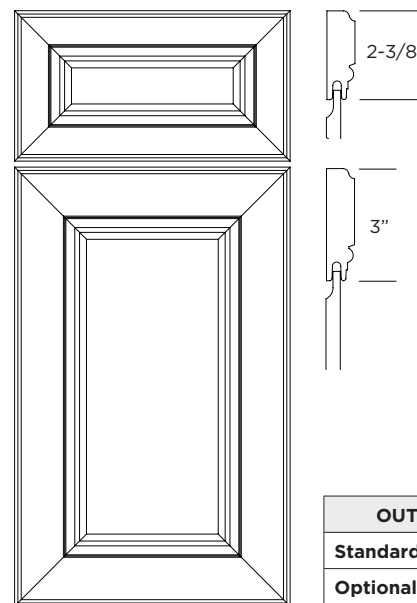

OUTER EDGE PROFILE	
<b>Standard:</b>	OD
<b>Optional:</b>	N/A



**DESIGN NOTE:**

- Drawer Fronts 4-3/4" high and less are Solid.
- Doors over 48" in height will be constructed with a horizontal center rail and 2 equally sized panels.

**DESIGN NOTE:**

- Drawer Fronts less than 5-1/2" high are Solid.
- Doors over 48" in height will be constructed as 2 equally sized doors attached together.

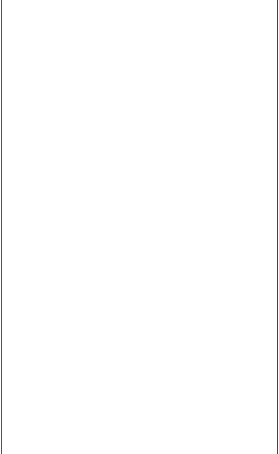
# ELAN DOOR STYLES

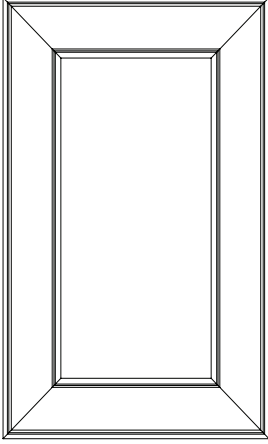
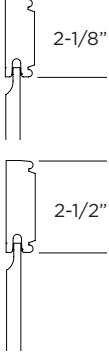
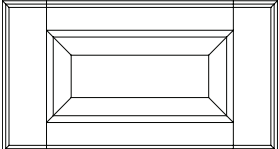
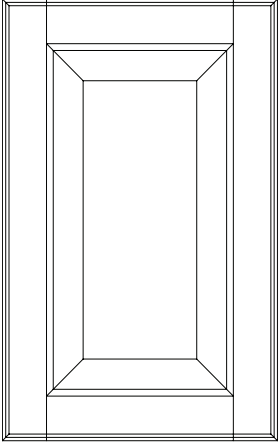
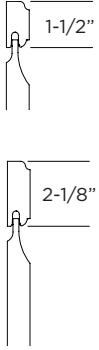
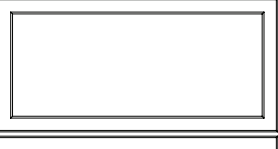
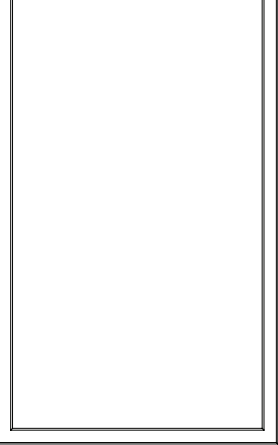
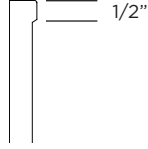
<b>SOLITAIRE</b> FULL OVERLAY		PRICE CODE <b>B</b>	<b>SONOMA</b> FULL OVERLAY		PRICE CODE <b>C</b>												
  <p>Door is edgebanded with matching PVC edgebanding. Verify availability. If matching PVC is not available, edges will be stripbanded with matching laminate (edges will be visible).</p> <table border="1"> <thead> <tr> <th colspan="2">OUTER EDGE PROFILE</th> </tr> </thead> <tbody> <tr> <td>Standard:</td> <td>OS</td> </tr> <tr> <td>Optional:</td> <td>N/A</td> </tr> </tbody> </table>		OUTER EDGE PROFILE		Standard:	OS	Optional:	N/A		   <table border="1"> <thead> <tr> <th colspan="2">OUTER EDGE PROFILE</th> </tr> </thead> <tbody> <tr> <td>Standard:</td> <td>Unique</td> </tr> <tr> <td>Optional:</td> <td>N/A</td> </tr> </tbody> </table>		OUTER EDGE PROFILE		Standard:	Unique	Optional:	N/A	
OUTER EDGE PROFILE																	
Standard:	OS																
Optional:	N/A																
OUTER EDGE PROFILE																	
Standard:	Unique																
Optional:	N/A																
<p><b>DESIGN NOTE:</b></p> <ul style="list-style-type: none"> <li>Available with High Pressure Laminate. Select from Formica or WilsonArt. Back of door matches face.</li> <li>Not available with glass or mullions.</li> <li>Verify pricing &amp; availability of laminate selection before ordering. Pricing will vary based on selection, matte or gloss and PVC availability.</li> </ul>			<p><b>DESIGN NOTE:</b></p> <ul style="list-style-type: none"> <li>Drawer Fronts less than 5-1/2" high are Solid with matching profile.</li> <li>Doors over 48" in height will be constructed with a horizontal center rail and 2 equally sized panels.</li> </ul>														
<b>STANFORD</b> FULL OVERLAY		PRICE CODE <b>C</b>	<b>SULLIVAN</b> FULL OVERLAY		PRICE CODE <b>B</b>												
   <table border="1"> <thead> <tr> <th colspan="2">OUTER EDGE PROFILE</th> </tr> </thead> <tbody> <tr> <td>Standard:</td> <td>OD</td> </tr> <tr> <td>Optional:</td> <td>3/8" Cove, G1, OA, OC, OG, OS, R1, SR</td> </tr> </tbody> </table>		OUTER EDGE PROFILE		Standard:	OD	Optional:	3/8" Cove, G1, OA, OC, OG, OS, R1, SR		   <table border="1"> <thead> <tr> <th colspan="2">OUTER EDGE PROFILE</th> </tr> </thead> <tbody> <tr> <td>Standard:</td> <td>SR</td> </tr> <tr> <td>Optional:</td> <td>N/A</td> </tr> </tbody> </table>		OUTER EDGE PROFILE		Standard:	SR	Optional:	N/A	
OUTER EDGE PROFILE																	
Standard:	OD																
Optional:	3/8" Cove, G1, OA, OC, OG, OS, R1, SR																
OUTER EDGE PROFILE																	
Standard:	SR																
Optional:	N/A																
<p><b>DESIGN NOTE:</b></p> <ul style="list-style-type: none"> <li>Drawer Fronts 4-3/4" high and less are Solid. Drawer Fronts less than 6-1/4" high to 4-3/4" are a flat panel. Drawer Fronts 6-1/4" high and over have a raised panel.</li> <li>Doors over 48" in height will be constructed with a horizontal center rail and 2 equally sized panels.</li> </ul>			<p><b>DESIGN NOTE:</b></p> <ul style="list-style-type: none"> <li>Available with Matte Foil only.</li> <li>Back of door is a matching or complimentary foil.</li> <li>Not available with glass or mullions.</li> <li>Maximum cabinet height with finished ends or finished interior is 96".</li> </ul>														

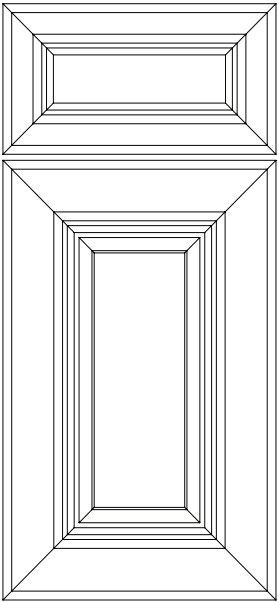
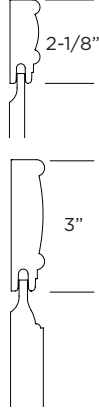
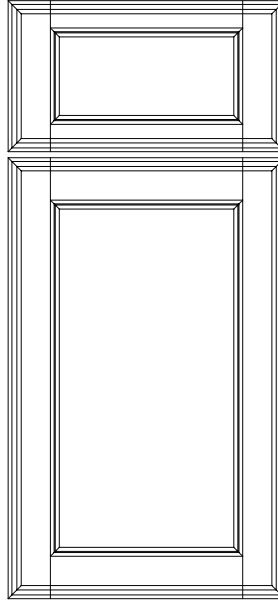
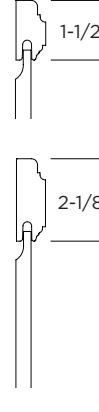
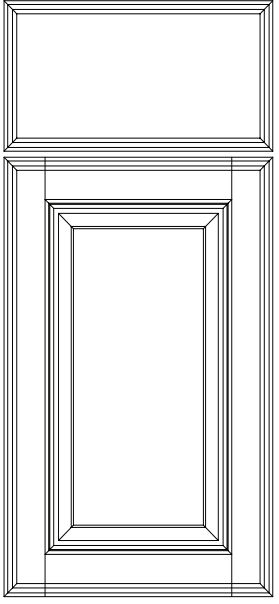
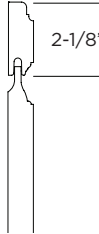
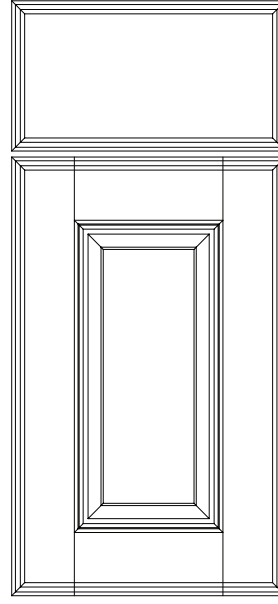
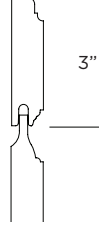

<h2 style="text-align: center;">TUSCANY</h2> <p style="text-align: center;">FULL OVERLAY</p> <div style="display: flex; justify-content: space-between;"> <div style="width: 45%;">  <div style="margin-top: 10px;">  </div> <table border="1" style="margin-top: 10px; width: 100%;"> <thead> <tr> <th colspan="2">OUTER EDGE PROFILE</th> </tr> </thead> <tbody> <tr> <td><b>Standard:</b></td> <td>Unique</td> </tr> <tr> <td><b>Optional:</b></td> <td>N/A</td> </tr> </tbody> </table> </div> <div style="width: 45%; text-align: right;"> <p><b>PRICE CODE</b> <b>E</b></p> </div> </div> <p><b>DESIGN NOTE:</b></p> <ul style="list-style-type: none"> <li>• Drawer Fronts less than 5-1/2" high are Solid with R1 profile.</li> <li>• Drawer Fronts 6-1/2" high and over have a raised panel.</li> <li>• Doors over 48" in height will be constructed as 2 equally sized doors attached together.</li> </ul>	OUTER EDGE PROFILE		<b>Standard:</b>	Unique	<b>Optional:</b>	N/A	<h2 style="text-align: center;">VENICE</h2> <p style="text-align: center;">FULL OVERLAY</p> <div style="display: flex; justify-content: space-between;"> <div style="width: 45%;">  <div style="margin-top: 10px;">  </div> <table border="1" style="margin-top: 10px; width: 100%;"> <thead> <tr> <th colspan="2">OUTER EDGE PROFILE</th> </tr> </thead> <tbody> <tr> <td><b>Standard:</b></td> <td>OC</td> </tr> <tr> <td><b>Optional:</b></td> <td>3/8" Cove, G1, OA, OD, OG, OS, R1, SR</td> </tr> </tbody> </table> </div> <div style="width: 45%; text-align: right;"> <p><b>PRICE CODE</b> <b>C</b></p> </div> </div> <p><b>DESIGN NOTE:</b></p> <ul style="list-style-type: none"> <li>• Drawer Fronts 4-3/4" high and less are Solid.</li> <li>• Doors over 48" in height will be constructed with a horizontal center rail and 2 equally sized panels.</li> </ul>	OUTER EDGE PROFILE		<b>Standard:</b>	OC	<b>Optional:</b>	3/8" Cove, G1, OA, OD, OG, OS, R1, SR
OUTER EDGE PROFILE													
<b>Standard:</b>	Unique												
<b>Optional:</b>	N/A												
OUTER EDGE PROFILE													
<b>Standard:</b>	OC												
<b>Optional:</b>	3/8" Cove, G1, OA, OD, OG, OS, R1, SR												
<h2 style="text-align: center;">VERONA</h2> <p style="text-align: center;">FULL OVERLAY</p> <div style="display: flex; justify-content: space-between;"> <div style="width: 45%;">  <div style="margin-top: 10px;">  </div> <table border="1" style="margin-top: 10px; width: 100%;"> <thead> <tr> <th colspan="2">OUTER EDGE PROFILE</th> </tr> </thead> <tbody> <tr> <td><b>Standard:</b></td> <td>OC</td> </tr> <tr> <td><b>Optional:</b></td> <td>3/8" Cove, G1, OA, OD, OG, OS, R1, SR</td> </tr> </tbody> </table> </div> <div style="width: 45%; text-align: right;"> <p><b>PRICE CODE</b> <b>B</b></p> </div> </div> <p><b>DESIGN NOTE:</b></p> <ul style="list-style-type: none"> <li>• Doors over 48" in height will be constructed with a horizontal center rail and 2 equally sized panels.</li> </ul>	OUTER EDGE PROFILE		<b>Standard:</b>	OC	<b>Optional:</b>	3/8" Cove, G1, OA, OD, OG, OS, R1, SR	<h2 style="text-align: center;">VERONA 3</h2> <p style="text-align: center;">FULL OVERLAY</p> <div style="display: flex; justify-content: space-between;"> <div style="width: 45%;">  <div style="margin-top: 10px;">  </div> <table border="1" style="margin-top: 10px; width: 100%;"> <thead> <tr> <th colspan="2">OUTER EDGE PROFILE</th> </tr> </thead> <tbody> <tr> <td><b>Standard:</b></td> <td>OC</td> </tr> <tr> <td><b>Optional:</b></td> <td>3/8" Cove, G1, OA, OD, OG, OS, R1, SR</td> </tr> </tbody> </table> </div> <div style="width: 45%; text-align: right;"> <p><b>PRICE CODE</b> <b>C</b></p> </div> </div> <p><b>DESIGN NOTE:</b></p> <ul style="list-style-type: none"> <li>• Doors over 48" in height will be constructed with a horizontal center rail and 2 equally sized panels.</li> </ul>	OUTER EDGE PROFILE		<b>Standard:</b>	OC	<b>Optional:</b>	3/8" Cove, G1, OA, OD, OG, OS, R1, SR
OUTER EDGE PROFILE													
<b>Standard:</b>	OC												
<b>Optional:</b>	3/8" Cove, G1, OA, OD, OG, OS, R1, SR												
OUTER EDGE PROFILE													
<b>Standard:</b>	OC												
<b>Optional:</b>	3/8" Cove, G1, OA, OD, OG, OS, R1, SR												

# ELAN DOOR STYLES

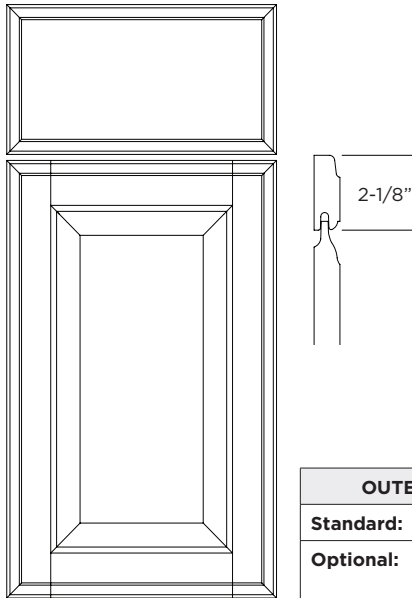
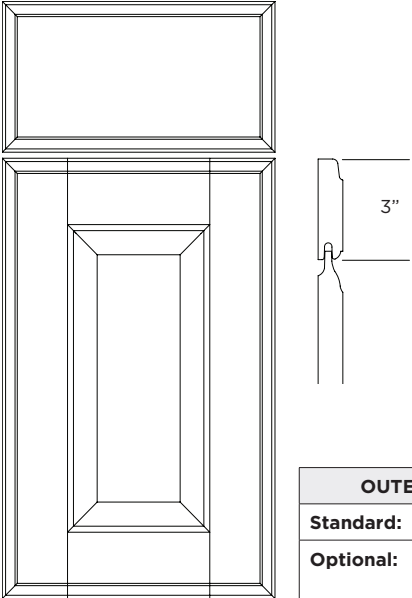
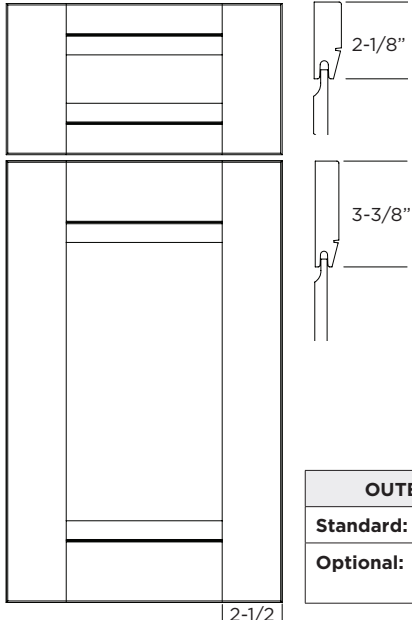
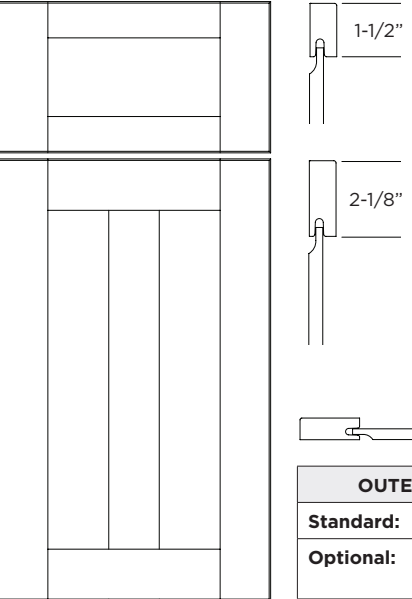
<h2>VILLAGER</h2> <p>FULL OVERLAY</p> <p><b>PRICE CODE B</b></p>  <table border="1" data-bbox="423 701 764 831"> <thead> <tr> <th colspan="2">OUTER EDGE PROFILE</th> </tr> </thead> <tbody> <tr> <td><b>Standard:</b></td> <td>OG</td> </tr> <tr> <td><b>Optional:</b></td> <td>3/8" Cove, G1, OA, OC, OD, OS, R1, SR</td> </tr> </tbody> </table> <p><b>DESIGN NOTE:</b></p> <ul style="list-style-type: none"> <li>Doors over 48" in height will be constructed with a horizontal center rail and 2 equally sized panels.</li> </ul>	OUTER EDGE PROFILE		<b>Standard:</b>	OG	<b>Optional:</b>	3/8" Cove, G1, OA, OC, OD, OS, R1, SR	<h2>VILLAGER 3</h2> <p>FULL OVERLAY</p> <p><b>PRICE CODE C</b></p>  <table border="1" data-bbox="1117 701 1458 831"> <thead> <tr> <th colspan="2">OUTER EDGE PROFILE</th> </tr> </thead> <tbody> <tr> <td><b>Standard:</b></td> <td>OG</td> </tr> <tr> <td><b>Optional:</b></td> <td>3/8" Cove, G1, OA, OC, OD, OS, R1, SR</td> </tr> </tbody> </table> <p><b>DESIGN NOTE:</b></p> <ul style="list-style-type: none"> <li>Doors over 48" in height will be constructed with a horizontal center rail and 2 equally sized panels.</li> </ul>	OUTER EDGE PROFILE		<b>Standard:</b>	OG	<b>Optional:</b>	3/8" Cove, G1, OA, OC, OD, OS, R1, SR
OUTER EDGE PROFILE													
<b>Standard:</b>	OG												
<b>Optional:</b>	3/8" Cove, G1, OA, OC, OD, OS, R1, SR												
OUTER EDGE PROFILE													
<b>Standard:</b>	OG												
<b>Optional:</b>	3/8" Cove, G1, OA, OC, OD, OS, R1, SR												
<h2>WICKER PARK</h2> <p>FULL OVERLAY</p> <p><b>PRICE CODE E</b></p>  <table border="1" data-bbox="423 1646 764 1776"> <thead> <tr> <th colspan="2">OUTER EDGE PROFILE</th> </tr> </thead> <tbody> <tr> <td><b>Standard:</b></td> <td>SR</td> </tr> <tr> <td><b>Optional:</b></td> <td>3/8" Cove, G1, OA, OC, OD, OG, OS, R1</td> </tr> </tbody> </table> <p><b>DESIGN NOTE:</b></p> <ul style="list-style-type: none"> <li>Drawer Fronts less than 5-1/2" high are Solid.</li> <li>Doors over 48" in height will be constructed with a center rail and 2 equally sized panels.</li> </ul>	OUTER EDGE PROFILE		<b>Standard:</b>	SR	<b>Optional:</b>	3/8" Cove, G1, OA, OC, OD, OG, OS, R1	<h2>WILLIAMSBURG</h2> <p>FULL OVERLAY</p> <p><b>PRICE CODE D</b></p>  <table border="1" data-bbox="1117 1646 1458 1776"> <thead> <tr> <th colspan="2">OUTER EDGE PROFILE</th> </tr> </thead> <tbody> <tr> <td><b>Standard:</b></td> <td>SR</td> </tr> <tr> <td><b>Optional:</b></td> <td>3/8" Cove, G1, OA, OC, OD, OG, OS, R1</td> </tr> </tbody> </table> <p><b>DESIGN NOTE:</b></p> <ul style="list-style-type: none"> <li>Drawer Fronts 4-3/4" high and less are Solid.</li> <li>Doors over 48" in height will be constructed with a horizontal center rail and 4 equally sized panels.</li> </ul>	OUTER EDGE PROFILE		<b>Standard:</b>	SR	<b>Optional:</b>	3/8" Cove, G1, OA, OC, OD, OG, OS, R1
OUTER EDGE PROFILE													
<b>Standard:</b>	SR												
<b>Optional:</b>	3/8" Cove, G1, OA, OC, OD, OG, OS, R1												
OUTER EDGE PROFILE													
<b>Standard:</b>	SR												
<b>Optional:</b>	3/8" Cove, G1, OA, OC, OD, OG, OS, R1												

**WINSTON**  
FULL OVERLAY

PRICE  
CODE **C**

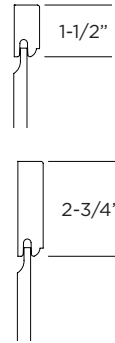
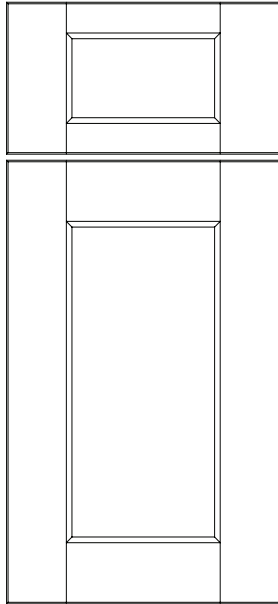

OUTER EDGE PROFILE	
<b>Standard:</b>	SR
<b>Optional:</b>	3/8" Cove, G1, OA, OC, OD, OG, OS, R1

**DESIGN NOTE:**

- Drawer Fronts 4-3/4" high and less are Solid.
- Doors over 48" in height will be constructed with a horizontal center rail and 2 equally sized panels.

**WOODBIDGE**  
FULL OVERLAY

PRICE  
CODE **F**

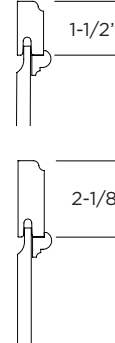
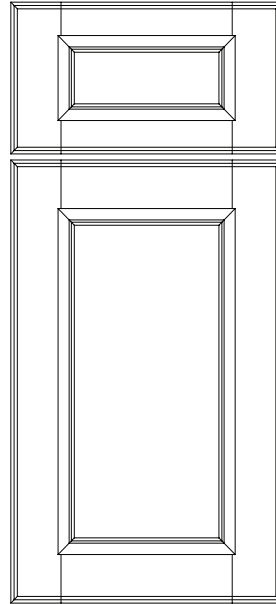

OUTER EDGE PROFILE	
<b>Standard:</b>	OD
<b>Optional:</b>	3/8" Cove, G1, OA, OC, OG, OS, R1, SR

**DESIGN NOTE:**

- A decorative molding is applied around panel perimeter on both Door & Drawer Fronts.
- Drawer Fronts less than 5-1/2" high are Solid.
- Doors over 48" in height will be constructed with a horizontal center rail and 2 equally sized panels.

# ELAN DOOR STYLES

## DOOR & DRAWER FRONT OPTION PRICING

### DOOR STYLE MODIFICATIONS

Changing Panel Selection.....5%

Changing Outside Edge Profile.....N/C

### DRAWER FRONT MODIFICATIONS

Changing Slab to 5 piece .....77 per drawer front.

Changing 5 Piece to Slab .....N/C

### CUSTOM DOOR STYLE

Send us a drawing, a photo, a picture, or a web address and we will custom quote the piece you are looking for.

**DOOR & DRAWER FRONT PROFILE REFERENCE**



3/8" COVE

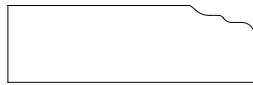

G1



OA



OC



OD



OG



OS



R1



SR

**DOOR & DRAWER FRONT OPTIONAL PANEL PROFILE REFERENCE**



PE

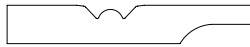

PF

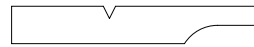

PG



PA

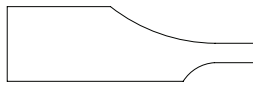

PD



PH

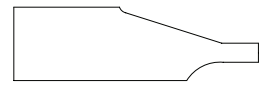

PN



PO

Interior of cabinet remains natural birch or white unless specified "Finished Interior".  
 Retainer gasket is supplied to secure glass. Exception: MDF, Mitered and Hickory doors will receive Retainer clips.  
 Doors over 48" high have an intermediate rail with mullion pattern in upper and lower section.  
 Style G Clear Glass is included.

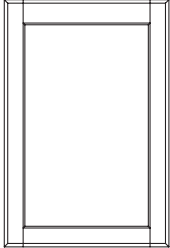
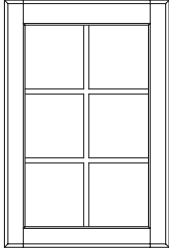
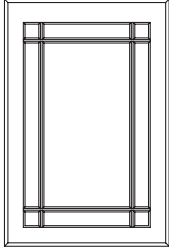
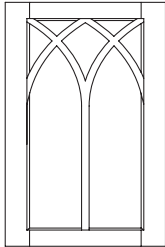
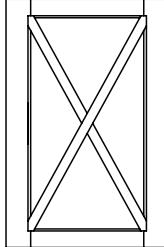
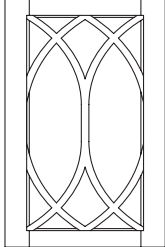
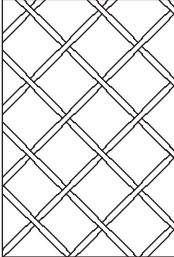
<p><b>Prepare Door For Glass (PDFG)</b> Includes Style "G" Clear Glass</p> <p>Minimum Cabinet Width 15" Cabinet Heights 12" to 48"</p>  <p><b>Price \$137</b></p> <p>PDFG available for all door styles.</p>	<p><b>Mullion Door (MD)</b> Includes Style "G" Clear Glass</p> <p>Minimum Cabinet Width 15" Cabinet Heights 15" to 48"</p>  <p><b>Price \$246</b></p> <table border="1"> <thead> <tr> <th>CABINET HEIGHT</th> <th>LITE QTY</th> </tr> </thead> <tbody> <tr> <td>&lt; 30"H</td> <td>4</td> </tr> <tr> <td>30-41"H</td> <td>6</td> </tr> <tr> <td>&gt; 41"H</td> <td>8</td> </tr> </tbody> </table> <p>See mullion chart for door style availability.</p>	CABINET HEIGHT	LITE QTY	< 30"H	4	30-41"H	6	> 41"H	8	<p><b>Country Mullion (CMD)</b> Includes Style "G" Clear Glass <i>Available in Square Framed Doors Only</i></p> <p>Minimum Cabinet Width 15" Cabinet Heights 15" to 48"</p>  <p><b>Price \$246</b></p> <p><b>Note:</b> Country Mullion doors on cabinets 36" or higher will receive a horizontal mullion in the center.</p> <p>See mullion chart for door style availability.</p>
CABINET HEIGHT	LITE QTY									
< 30"H	4									
30-41"H	6									
> 41"H	8									
<p><b>Raphael Mullion (RMD)</b> Includes Style "G" Clear Glass <i>Available in Square Framed Doors Only</i></p> <p>Minimum Cabinet Width 18" Cabinet Heights 18" to 42"</p>  <p><b>Price \$1208</b></p> <p><b>Note:</b> 3" rail and stile door styles have a minimum cabinet width of 21"</p> <p>See mullion chart for door style availability.</p>	<p><b>Pascal Mullion (PMD)</b> Includes Style "G" Clear Glass <i>Available in Square Framed Doors Only</i></p> <p>Minimum Cabinet Width 18" Cabinet Height 18" to 42"</p>  <p><b>Price \$923</b></p> <p><b>Note:</b> 3" rail and stile door styles have a minimum cabinet width of 21"</p> <p>See mullion chart for door style availability.</p>	<p><b>Bernini Mullion (BMD)</b> Includes Style "G" Clear Glass <i>Available in Square Framed Doors Only</i></p> <p>Minimum Cabinet Width 18" Cabinet Heights 27" to 42"</p>  <p><b>Price \$1713</b></p> <p><b>Note:</b> 3" rail and stile door styles have a minimum cabinet width of 21"</p> <p>See mullion chart for door style availability.</p>								
<p><b>Brass Grille Inserts (BGI)</b> 5/8" Antique Brass Decorative Grille</p> <p>Minimum Cabinet Width 15" Cabinet Heights 12" to 48"</p>  <p><b>Price \$125/sq. ft.</b></p> <p>BGI available for all door styles.</p>										

DOOR STYLES	MULLION DOOR (MD)	COUNTRY MULLION (CMD)	Raphael Mullion (RMD) Pascal Mullion (PMD) Bernini Mullion (BMD)
ASHTON			
BECKETT	X	X	X
BRIDGEPORT	X	X	X
BRISTOL	X	X	
CAPELA	X	X	
CLARKSON*	X		
CRAFTWOOD	X	X	
DAWSON			
DELANEY	X	X	X
DISTRICT	X	X	X
EDGEWOOD	X	X	
EMERSON	X	X	
HUNTINGTON			
HUTTON	X	X	X
JOSS	X		
KINGSTON 3	X	X	X
LEXINGTON	X	X	X
LEXINGTON 3	X	X	X
MARCUS			
MONTEREY	X	X	
NORTHBROOK	X	X	X
ODESSA*	X	X	X
OXFORD 3	X	X	X
PALERMO	X		
PORTLAND	X	X	X
QUINCY	X	X	X
QUINCY 3	X	X	X
RIDLEY	X		
RIVERSIDE*	X	X	X
ROYALE	X	X	X
SAWYER	X	X	
SEVILLE	X	X	
SOLITAIRE			
SONOMA	X	X	
STANFORD	X	X	X
SULLIVAN			
TUSCANY	X	X	
VENICE	X	X	
VERONA	X	X	
VERONA 3	X	X	
VILLAGER	X	X	X
VILLAGER 3	X	X	X
WICKER PARK	X		
WILLIAMSBURG	X	X	X
WINSTON	X	X	X
WOODBRIE	X	X	

\* Slab doors default to frame doors with 2-1/8" stiles and rails.

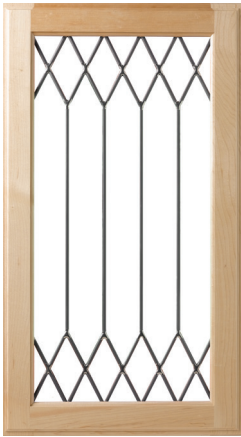

**DIAMOND  
STYLE "A"**  
*Square Door Only*  
Min. Cabinet Height 24"  
Min. Cabinet Width 15"



**TRADITIONAL  
STYLE "B"**  
*Square Door Only*  
Min. Cabinet Height 24"  
Min. Cabinet Width 15"



**DOUBLE CLEAR BEVEL  
STYLE "C"**  
*Square Door Only*  
Min. Cabinet Height 24"  
Min. Cabinet Width 12"

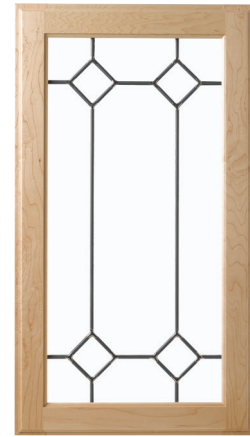

**QUADRANT CLEAR BEVEL  
STYLE "D"**  
*Square Door Only*  
Min. Cabinet Height 24"  
Min. Cabinet Width 15"

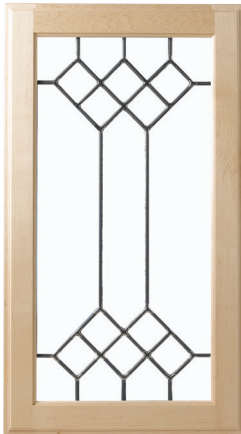

**CLEAR BEVEL CLUSTERS  
STYLE "E"**  
*Square Door Only*  
Min. Cabinet Height 24"  
Min. Cabinet Width 18"



**CONTEMPARY  
STYLE "H"**  
*Square Door Only*  
Min. Cabinet Height 30"  
Min. Cabinet Width 18"



**WINDOWPANE  
STYLE "K"**  
*Square Door Only*



**CLEAR BEVEL WINDOWPANE  
STYLE "L"**  
*Square Door Only*  
Min. Cabinet Height 18"  
Min. Cabinet Width 12"



**CLEAR BEVEL  
STYLE "F"**



**CLEAR  
STYLE "G"**



**CLEAR WITH TEXTURE  
STYLE "G1"**



**Textures for Leaded Glass Styles A, B, C, D, E, H, and K**

1. Clear 1/8"
2. Frosted
3. Single Gluechip
4. Clear Artique
5. Clear Waterglass
6. Clear Seedy Cathedral
7. Clear Baroque
8. Clear Vecchio

**Clear Texture for Style G1**

2. Frosted
3. Single Gluechip
4. Clear Artique
5. Clear Waterglass
6. Clear Seedy Cathedral
7. Clear Baroque
8. Clear Vecchio
9. Reeded

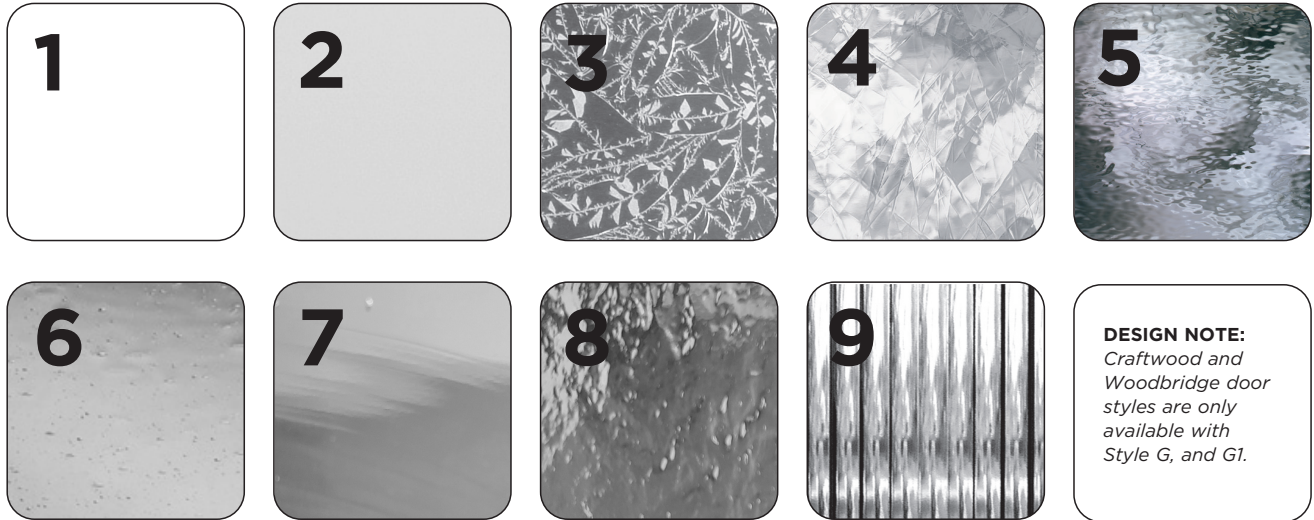

*Printing technology does not allow for perfectly accurate reproduction of color and texture. Actual sample may vary.*

**PRICING**

LEADED GLASS ORDER FORM IS LOCATED IN THE FORM SECTION OF THE CATALOG.

CABINET HEIGHT	STYLE A	STYLE B	STYLE C	STYLE D	STYLE E	STYLE H	STYLE K	STYLE L	STYLE F	STYLE G	STYLE G1
12"	N/A	N/A	N/A	N/A	N/A	N/A	N/A	N/A	174	137	226
15"	N/A	N/A	N/A	N/A	N/A	N/A	458	N/A	174	137	226
18"	N/A	N/A	N/A	N/A	N/A	N/A	504	504	174	137	226
21"	N/A	N/A	N/A	N/A	N/A	N/A	532	532	197	137	273
24"	575	575	575	575	575	N/A	575	575	197	137	273
27"	589	589	589	589	589	N/A	589	589	197	137	273
30"	644	644	644	644	644	718	644	644	222	137	374
36"	663	663	663	663	663	741	663	663	222	137	374
39"	681	681	681	681	681	764	681	681	222	137	374
42"	699	699	699	699	699	787	699	699	222	137	374
48"	811	811	811	811	811	935	811	811	222	137	374





**TABLE OF CONTENTS**

**ELAN WALL CABINETS.... E100-1 THRU E100-17**

Standard Wall Cabinets ..... E100-2 thru E100-6  
Refrigerator Wall Cabinets ..... E100-7 thru E100-10  
Split Wall Cabinets..... E100-11  
Wall with Tambour..... E100-12  
Wall with Appliance Garage..... E100-13  
Wall with Lift Up Appliance Garage ..... E100-14  
Wall with 1 Drawer ..... E100-15  
Wall with 2 Drawer ..... E100-16  
Wall with 3 Drawers ..... E100-17



# ELAN WALL CABINETS

## WALL CABINETS 12", 15" & 18" HIGH

### SINGLE DOOR

- Specify Hinge (L or R)
- 9"W - 24-1"W

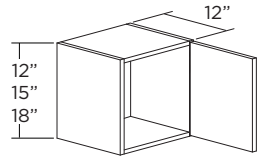

### BUTT DOORS

24-2"W - 36"W

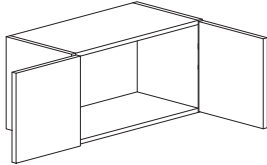

### DOUBLE DOORS

39"W - 48-2"W

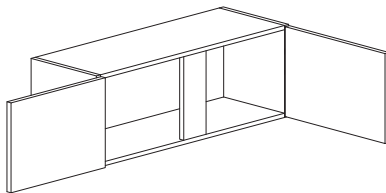

12" HIGH	A	B	C	D	E	F	G
No Shelves							
EW912	337	355	372	389	416	433	452
EW1212	358	377	395	412	441	460	480
EW1512	380	400	419	438	468	488	510
EW1812	399	419	439	458	490	511	534
EW2112	424	446	467	489	522	544	568
EW2412-1	463	487	510	533	571	594	621
EW2412-2	588	619	648	677	724	753	789
EW2712	611	642	672	703	752	782	819
EW3012	634	666	698	730	781	813	851
EW3312	656	689	722	756	808	841	880
EW3612	676	710	745	778	833	866	907
EW3912*	700	735	770	805	862	897	939
EW4212*	724	761	797	834	891	928	971
EW4512*	746	783	822	859	919	956	1001
EW4812-2	768	807	846	884	946	984	1031

\* Hinged at Top

15" HIGH	A	B	C	D	E	F	G
No Shelves							
EW915	359	378	396	414	443	461	482
EW1215	375	395	413	433	462	480	504
EW1515	400	421	440	461	493	512	537
EW1815	421	443	463	484	518	539	564
EW2115	445	468	490	512	548	570	597
EW2415-1	463	487	510	533	571	594	621
EW2415-2	572	601	630	659	704	734	768
EW2715	643	676	708	740	791	824	862
EW3015	665	699	732	765	819	852	891
EW3315	696	731	765	801	856	891	933
EW3615	709	745	780	815	873	908	951
EW3915	733	770	807	844	901	939	982
EW4215	758	797	834	872	933	971	1016
EW4515	793	833	871	912	976	1016	1063
EW4815-2	808	849	889	929	994	1035	1083

18" HIGH	A	B	C	D	E	F	G
1 Adjustable Shelf							
EW918	394	414	434	454	485	505	528
EW1218	421	443	463	484	518	539	564
EW1518	454	477	500	522	559	581	609
EW1818	476	500	523	548	586	609	638
EW2118	505	531	556	581	621	647	677
EW2418-1	533	560	587	614	656	683	715
EW2418-2	649	682	715	747	800	831	870
EW2718	682	716	751	785	840	874	914
EW3018	710	747	782	818	874	910	952
EW3318	738	776	813	850	908	946	990
EW3618	760	800	837	875	936	974	1020
EW3918	795	834	874	915	979	1018	1065
EW4218	827	870	911	953	1019	1061	1110
EW4518	860	904	948	990	1058	1102	1154
EW4818-2	886	932	975	1020	1091	1135	1189

# ELAN WALL CABINETS

## WALL CABINETS 21" & 24" HIGH

- 1 Adjustable Shelf

### SINGLE DOOR

- Specify Hinge (L or R)
- 9"W - 24-1"W

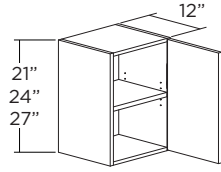

### BUTT DOORS 24-2"W - 36"W

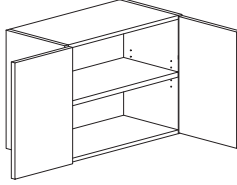

### DOUBLE DOORS 39"W - 48-2"W

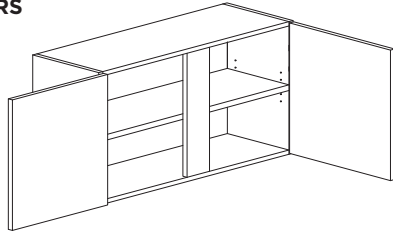

21" HIGH	A	B	C	D	E	F	G
EW921	408	429	450	471	502	523	548
EW1221	435	457	479	501	535	557	584
EW1521	468	493	516	539	577	600	628
EW1821	501	527	551	577	617	642	672
EW2121	529	556	583	609	652	678	710
EW2421-1	560	588	616	644	689	718	751
EW2421-2	681	715	749	784	839	872	913
EW2721	719	756	791	828	885	921	963
EW3021	742	780	817	855	913	950	995
EW3321	776	815	855	894	956	994	1040
EW3621	800	840	880	921	984	1024	1072
EW3921	823	864	906	946	1012	1054	1103
EW4221	847	890	933	974	1043	1086	1136
EW4521	873	917	962	1004	1073	1118	1171
EW4821-2	898	944	990	1034	1107	1152	1205

24" HIGH	A	B	C	D	E	F	G
EW924	425	447	468	490	524	545	571
EW1224	452	476	498	521	557	579	606
EW1524	489	513	538	562	601	626	655
EW1824	515	542	567	593	633	659	691
EW2124	553	581	609	636	680	708	741
EW2424-1	583	612	642	671	718	747	782
EW2424-2	737	775	812	848	907	944	989
EW2724	776	815	855	894	956	994	1040
EW3024	802	842	883	923	987	1027	1076
EW3324	841	884	925	968	1035	1077	1127
EW3624	868	912	955	999	1068	1111	1164
EW3924	894	939	984	1028	1100	1144	1198
EW4224	921	967	1013	1059	1133	1178	1235
EW4524	947	995	1043	1090	1166	1213	1270
EW4824-2	974	1024	1073	1121	1200	1248	1306

## WALL CABINETS 27" HIGH

- 2 Adjustable Shelves

### SINGLE DOOR

- Specify Hinge (L or R)
- 9"W - 24-1"W

### BUTT DOORS 24-2"W - 36"W

### DOUBLE DOORS 39"W - 48-2"W

27" HIGH	A	B	C	D	E	F	G
EW927	432	454	476	496	532	553	579
EW1227	456	479	502	524	561	584	611
EW1527	499	524	549	575	614	639	669
EW1827	526	553	578	605	647	674	705
EW2127	565	594	622	650	696	724	758
EW2427-1	599	630	659	689	737	768	803
EW2427-2	745	782	819	857	917	954	999
EW2727	789	829	868	907	971	1010	1057
EW3027	818	859	900	941	1006	1048	1097
EW3327	856	899	941	984	1053	1095	1147
EW3627	885	930	974	1018	1089	1133	1187
EW3927	914	961	1006	1053	1126	1171	1226
EW4227	951	999	1046	1094	1170	1218	1275
EW4527	979	1029	1078	1127	1205	1254	1313
EW4827-2	1028	1081	1132	1183	1265	1317	1378

# ELAN WALL CABINETS

## WALL CABINETS

### 30", 33" & 36" HIGH

- 2 Adjustable Shelves

#### SINGLE DOOR

- Specify Hinge (L or R)
- 9"W - 24-1"W

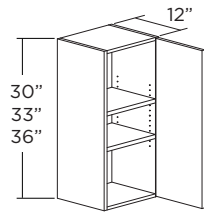

#### BUTT DOORS

- 24-2"W - 36"W

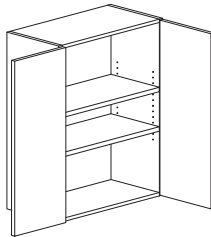

#### DOUBLE DOORS

- 39"W - 48-2"W

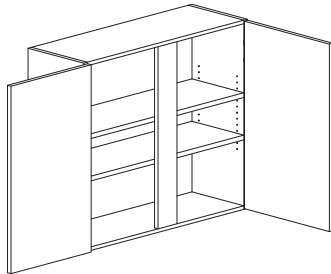

30" HIGH	A	B	C	D	E	F	G
EW930	450	473	495	518	554	577	604
EW1230	474	499	522	546	584	608	636
EW1530	518	545	571	597	638	664	696
EW1830	550	578	605	633	677	704	737
EW2130	590	621	650	680	727	757	792
EW2430-1	628	660	692	724	774	804	842
EW2430-2	770	809	847	886	947	987	1033
EW2730	819	861	901	943	1009	1049	1098
EW3030	852	895	938	980	1049	1092	1142
EW3330	892	938	982	1027	1098	1143	1197
EW3630	923	969	1016	1062	1136	1182	1237
EW3930	955	1004	1051	1099	1175	1223	1280
EW4230	1004	1055	1105	1155	1235	1285	1346
EW4530	1034	1087	1138	1189	1273	1324	1386
EW4830-2	1065	1119	1172	1225	1311	1363	1428

33" HIGH	A	B	C	D	E	F	G
EW933	473	497	521	544	583	606	634
EW1233	524	550	577	604	645	671	703
EW1533	563	593	620	648	694	723	756
EW1833	605	636	666	696	744	775	811
EW2133	650	683	715	748	799	833	872
EW2433-1	688	723	758	792	848	883	924
EW2433-2	836	879	920	962	1029	1071	1121
EW2733	895	940	985	1030	1101	1146	1200
EW3033	931	979	1025	1072	1147	1193	1250
EW3333	978	1028	1075	1126	1204	1252	1310
EW3633	1009	1061	1112	1163	1242	1293	1355
EW3933	1043	1096	1147	1200	1283	1335	1398
EW4233	1068	1122	1175	1230	1314	1367	1432
EW4533	1090	1145	1200	1256	1340	1396	1460
EW4833-2	1120	1175	1232	1288	1378	1434	1501

36" HIGH	A	B	C	D	E	F	G
EW936	502	528	554	578	619	644	674
EW1236	557	586	614	642	686	714	748
EW1536	599	630	659	689	737	768	803
EW1836	643	676	708	740	791	824	862
EW2136	691	726	760	795	850	885	927
EW2436-1	732	769	806	842	901	938	982
EW2436-2	889	934	978	1023	1094	1138	1192
EW2736	951	999	1046	1094	1170	1218	1275
EW3036	990	1040	1089	1139	1219	1268	1328
EW3336	1039	1092	1143	1196	1279	1330	1392
EW3636	1073	1127	1181	1235	1320	1374	1439
EW3936	1108	1164	1219	1274	1363	1418	1485
EW4236	1134	1192	1248	1306	1396	1452	1521
EW4536	1158	1216	1274	1333	1424	1483	1551
EW4836-2	1189	1249	1309	1368	1463	1523	1594

# ELAN WALL CABINETS

## WALL CABINETS 39", 42" & 48" HIGH

- 3 Adjustable Shelves

### SINGLE DOOR

- Specify Hinge (L or R)
- 9"W - 24-1"W

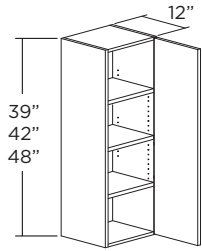

### BUTT DOORS

24-2"W - 36"W

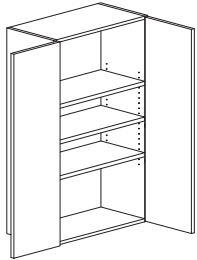

### DOUBLE DOORS

39"W - 48-2"W

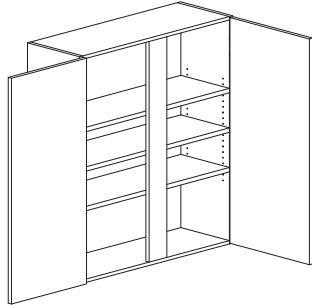

39" HIGH	A	B	C	D	E	F	G
EW939	539	567	594	621	664	691	722
EW1239	589	620	649	678	725	754	790
EW1539	639	672	704	736	787	819	857
EW1839	685	719	753	787	842	877	918
EW2139	740	778	814	851	911	947	991
EW2439-1	782	822	861	900	963	1002	1049
EW2439-2	944	991	1039	1086	1161	1209	1265
EW2739	1007	1059	1109	1159	1240	1290	1351
EW3039	1049	1101	1154	1207	1291	1344	1406
EW3339	1105	1161	1216	1271	1359	1416	1482
EW3639	1141	1198	1256	1312	1403	1461	1529
EW3939	1178	1238	1297	1356	1450	1509	1579
EW4239	1214	1275	1336	1396	1494	1555	1627
EW4539	1252	1315	1378	1440	1540	1603	1678
EW4839-2	1289	1353	1418	1483	1586	1650	1727

42" HIGH	A	B	C	D	E	F	G
EW942	575	604	632	661	708	736	770
EW1242	622	654	685	716	767	797	835
EW1542	680	714	748	782	836	870	912
EW1842	726	763	800	836	894	930	973
EW2142	787	828	867	906	969	1009	1055
EW2442-1	833	875	917	958	1024	1066	1116
EW2442-2	995	1045	1095	1145	1225	1274	1334
EW2742	1061	1115	1167	1221	1306	1359	1423
EW3042	1106	1163	1218	1273	1362	1417	1483
EW3342	1165	1224	1282	1340	1434	1491	1562
EW3642	1208	1269	1329	1390	1487	1546	1619
EW3942	1249	1313	1375	1438	1538	1600	1675
EW4242	1292	1357	1422	1487	1590	1654	1732
EW4542	1337	1405	1472	1539	1645	1713	1792
EW4842-2	1380	1450	1518	1588	1698	1768	1850

48" HIGH	A	B	C	D	E	F	G
EW948	656	689	722	755	808	840	879
EW1248	710	746	781	817	875	910	953
EW1548	775	815	853	892	954	993	1041
EW1848	828	870	912	954	1020	1061	1110
EW2148	898	944	989	1034	1106	1151	1204
EW2448-1	951	998	1046	1093	1168	1216	1274
EW2448-2	1135	1192	1249	1306	1397	1453	1522
EW2748	1210	1272	1332	1393	1489	1550	1624
EW3048	1262	1326	1389	1453	1553	1617	1691
EW3348	1329	1397	1462	1528	1636	1701	1782
EW3648	1378	1447	1517	1586	1696	1764	1846
EW3948	1425	1498	1568	1640	1754	1826	1911
EW4248	1473	1549	1623	1697	1813	1886	1976
EW4548	1527	1603	1680	1755	1877	1955	2044
EW4848-2	1575	1654	1732	1811	1937	2016	2111

# ELAN WALL CABINETS

## WALL CABINETS 54", 57" & 60" HIGH

- 4 Adjustable Shelves

### SINGLE DOOR

- Specify Hinge (L or R)
- 9"W - 24-1"W

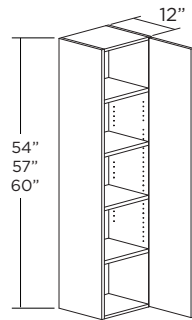

### BUTT DOORS

24-2"W - 36"W

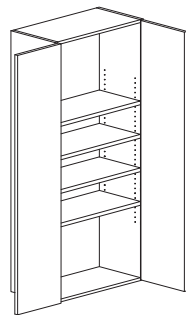

### DOUBLE DOORS

39"W - 48-2"W

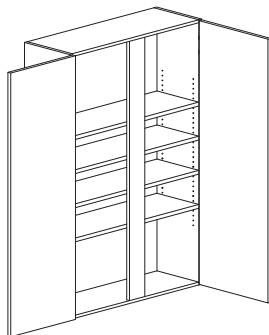

54" HIGH	A	B	C	D	E	F	G
EW954	758	796	834	872	934	971	1015
EW1254	821	862	903	944	1012	1051	1101
EW1554	896	942	986	1031	1103	1147	1203
EW1854	957	1006	1054	1102	1179	1226	1282
EW2154	1037	1091	1143	1195	1278	1330	1391
EW2454-1	1099	1154	1209	1263	1350	1405	1472
EW2454-2	1312	1377	1443	1510	1614	1679	1759
EW2754	1398	1470	1539	1609	1721	1791	1877
EW3054	1458	1533	1605	1678	1795	1868	1954
EW3354	1536	1614	1690	1766	1890	1966	2059
EW3654	1592	1672	1752	1833	1960	2038	2134
EW3954	1647	1731	1812	1895	2027	2110	2208
EW4254	1703	1789	1875	1961	2095	2180	2283
EW4554	1764	1852	1941	2028	2169	2260	2361
EW4854-2	1820	1911	2001	2093	2238	2330	2439

57" HIGH	A	B	C	D	E	F	G
EW957	874	919	962	1006	1078	1120	1171
EW1257	947	995	1042	1089	1167	1213	1270
EW1557	1034	1086	1137	1190	1272	1323	1387
EW1857	1104	1160	1216	1272	1360	1414	1479
EW2157	1197	1259	1318	1378	1474	1535	1605
EW2457-1	1267	1331	1395	1457	1557	1621	1698
EW2457-2	1513	1589	1665	1741	1862	1937	2029
EW2757	1613	1695	1775	1856	1985	2066	2165
EW3057	1682	1768	1851	1936	2070	2155	2254
EW3357	1772	1862	1949	2037	2180	2268	2376
EW3657	1837	1929	2021	2114	2261	2351	2461
EW3957	1900	1996	2090	2186	2338	2434	2547
EW4257	1964	2064	2163	2262	2417	2514	2634
EW4557	2035	2137	2239	2339	2502	2607	2724
EW4857-2	2100	2205	2309	2414	2582	2688	2813

60" HIGH	A	B	C	D	E	F	G
EW960	1007	1058	1108	1159	1241	1290	1349
EW1260	1090	1146	1200	1255	1344	1397	1463
EW1560	1191	1251	1310	1370	1465	1524	1598
EW1860	1272	1336	1401	1465	1566	1629	1704
EW2160	1378	1450	1518	1588	1698	1768	1849
EW2460-1	1460	1533	1606	1678	1793	1867	1956
EW2460-2	1743	1830	1918	2006	2145	2231	2337
EW2760	1858	1953	2045	2138	2287	2380	2494
EW3060	1938	2037	2132	2230	2385	2483	2597
EW3360	2041	2145	2245	2346	2511	2612	2737
EW3660	2116	2222	2328	2435	2604	2708	2835
EW3960	2188	2300	2408	2518	2693	2803	2934
EW4260	2262	2378	2492	2606	2784	2896	3034
EW4560	2344	2461	2579	2695	2882	3002	3138
EW4860-2	2419	2540	2659	2781	2974	3096	3241

**DESIGN NOTES:** Doors will be constructed with a horizontal center rail and equally sized panels.



# ELAN WALL CABINETS

## REFRIGERATOR WALL 12" & 15" HIGH 24" DEEP

- No Shelves

### BUTT DOORS 30"W - 37"W

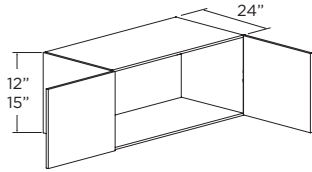

### DOUBLE DOORS 39"W - 48-2"W

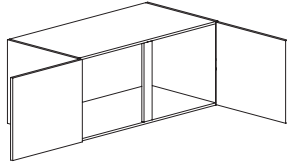

12" HIGH	A	B	C	D	E	F	G
ERW3012	734	770	807	844	902	939	983
ERW3312	763	802	840	878	939	977	1023
ERW3612	786	826	866	905	967	1007	1054
ERW3712	803	843	883	923	987	1028	1076
ERW3912*	820	860	901	942	1008	1049	1098
ERW4212*	843	886	929	971	1037	1081	1131
ERW4812-2*	869	912	957	1000	1068	1113	1165

\* Hinge on Top

15" HIGH	A	B	C	D	E	F	G
ERW3015	768	807	845	884	945	983	1029
ERW3315	801	841	881	922	985	1026	1073
ERW3615	824	866	907	949	1015	1055	1105
ERW3715	840	883	926	968	1034	1076	1126
ERW3915	859	902	946	989	1057	1101	1151
ERW4215	885	929	973	1019	1089	1132	1186
ERW4815-2	912	957	1004	1049	1121	1168	1222

## REFRIGERATOR WALL 18", 21", 24" & 27" HIGH 24" DEEP

- 1 Adjustable Shelf

### BUTT DOORS 30"W - 37"W

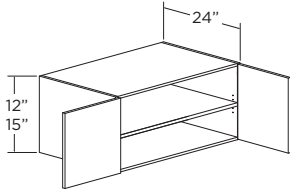

### DOUBLE DOORS 39"W - 48-2"W

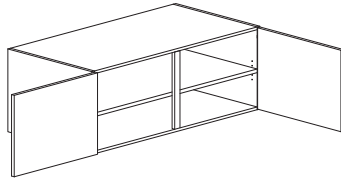

18" HIGH	A	B	C	D	E	F	G
ERW3018	808	850	890	930	995	1035	1083
ERW3318	840	883	924	967	1034	1076	1126
ERW3618	874	918	962	1006	1076	1120	1172
ERW3718	889	935	979	1023	1095	1139	1192
ERW3918	908	954	998	1044	1117	1162	1216
ERW4218	944	991	1039	1086	1162	1210	1266
ERW4818-2	981	1030	1077	1128	1206	1256	1314

21" HIGH	A	B	C	D	E	F	G
ERW3021	846	889	932	973	1042	1083	1134
ERW3321	881	927	971	1015	1084	1128	1182
ERW3621	917	963	1009	1055	1128	1174	1229
ERW3721	935	982	1029	1077	1150	1197	1253
ERW3921	954	1001	1049	1097	1174	1221	1279
ERW4221	982	1032	1081	1130	1208	1257	1317
ERW4821-2	1012	1064	1114	1165	1246	1296	1358

24" HIGH	A	B	C	D	E	F	G
ERW3024	884	929	973	1017	1088	1132	1185
ERW3324	923	969	1016	1062	1136	1182	1237
ERW3624	960	1009	1056	1104	1181	1229	1286
ERW3724	974	1024	1072	1120	1198	1247	1306
ERW3924	990	1040	1089	1139	1219	1268	1328
ERW4224	1020	1071	1122	1174	1254	1306	1367
ERW4824-2	1050	1103	1155	1208	1292	1345	1408

27" HIGH	A	B	C	D	E	F	G
ERW3027	927	973	1020	1066	1141	1187	1242
ERW3327	971	1020	1068	1117	1194	1243	1301
ERW3627	1015	1066	1116	1167	1248	1300	1361
ERW3727	1036	1087	1138	1190	1273	1327	1389
ERW3927	1056	1110	1163	1215	1300	1352	1416
ERW4227	1099	1154	1209	1264	1352	1407	1473
ERW4827-2	1142	1199	1257	1314	1405	1462	1531

# ELAN WALL CABINETS

## REFRIGERATOR WALL

30", 33" & 36" HIGH

24" DEEP

- 2 Adjustable Shelves

### BUTT DOORS

30"W - 37"W

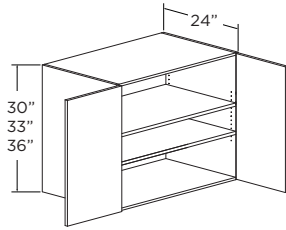

### DOUBLE DOORS

39"W - 48-2"W

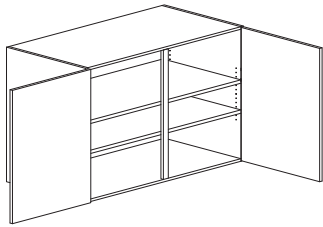

30" HIGH	A	B	C	D	E	F	G
ERW3030	970	1019	1068	1117	1195	1243	1300
ERW3330	1017	1068	1118	1169	1250	1301	1362
ERW3630	1063	1116	1168	1222	1306	1361	1425
ERW3730	1085	1138	1191	1246	1333	1389	1454
ERW3930	1106	1162	1218	1272	1362	1415	1483
ERW4230	1151	1208	1266	1323	1416	1473	1542
ERW4830-2	1196	1255	1316	1376	1471	1530	1603

33" HIGH	A	B	C	D	E	F	G
ERW3033	1016	1067	1118	1169	1251	1301	1361
ERW3333	1121	1178	1233	1289	1379	1435	1503
ERW3633	1172	1231	1288	1347	1441	1501	1571
ERW3733	1197	1255	1314	1374	1470	1533	1604
ERW3933	1219	1281	1343	1403	1502	1561	1635
ERW4233	1269	1333	1397	1459	1562	1625	1701
ERW4833-2	1319	1385	1451	1518	1623	1688	1768

36" HIGH	A	B	C	D	E	F	G
ERW3036	1064	1117	1170	1224	1310	1362	1425
ERW3336	1174	1233	1291	1350	1444	1503	1573
ERW3636	1227	1288	1349	1411	1509	1572	1645
ERW3736	1253	1314	1376	1439	1539	1605	1679
ERW3936	1277	1342	1406	1469	1573	1634	1712
ERW4236	1329	1395	1462	1528	1635	1701	1781
ERW4836-2	1381	1450	1519	1589	1699	1767	1851

# ELAN WALL CABINETS

## REFRIGERATOR WALL 12" & 15" HIGH 27" DEEP

- No Shelves

### BUTT DOORS 30"W - 37"W

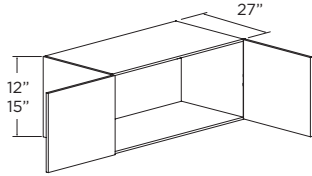

### DOUBLE DOORS 39"W - 48-2"W

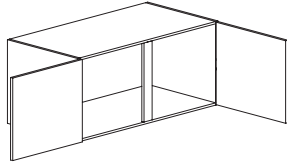

12" HIGH	A	B	C	D	E	F	G
ERW301227	784	820	857	894	952	989	1033
ERW331227	813	852	890	928	989	1027	1073
ERW361227	813	876	916	955	1017	1057	1104
ERW371227	853	893	933	973	1037	1078	1126
ERW391227*	870	910	951	992	1058	1099	1148
ERW421227*	893	936	979	1021	1087	1131	1181
ERW481227-2*	919	962	1007	1050	1118	1163	1215

\* Hinge on Top

15" HIGH	A	B	C	D	E	F	G
ERW301527	818	857	895	934	995	1033	1079
ERW331527	851	891	931	972	1035	1076	1123
ERW361527	874	916	957	999	1084	1105	1155
ERW371527	890	933	976	1018	1084	1126	1176
ERW391527	909	952	996	1039	1107	1151	1201
ERW421527	935	979	1023	1069	1139	1182	1236
ERW481527-2	962	1007	1054	1099	1171	1218	1272

## REFRIGERATOR WALL 18", 21", 24" & 27" HIGH 27" DEEP

- 1 Adjustable Shelf

### BUTT DOORS 30"W - 37"W

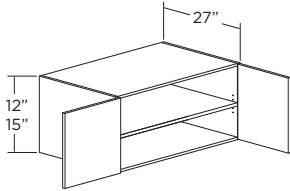

### DOUBLE DOORS 39"W - 48-2"W

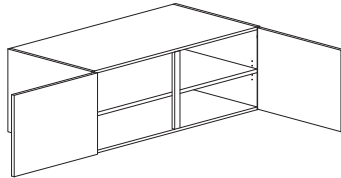

18" HIGH	A	B	C	D	E	F	G
ERW301827	858	900	940	980	1045	1085	1133
ERW331827	890	933	974	1017	1084	1126	1176
ERW361827	924	968	1012	1056	1126	1170	1222
ERW371827	939	985	1029	1073	1145	1189	1242
ERW391827	958	1004	1048	1094	1167	1212	1266
ERW421827	994	1041	1089	1136	1212	1260	1316
ERW481827-2	1031	1080	1127	1178	1256	1306	1367

21" HIGH	A	B	C	D	E	F	G
ERW302127	896	939	982	1023	1092	1133	1184
ERW332127	931	977	1021	1065	1134	1178	1232
ERW362127	967	1013	1059	1105	1178	1224	1279
ERW372127	985	1032	1079	1127	1200	1247	1303
ERW392127	1004	1051	1099	1147	1224	1271	1329
ERW422127	1032	1082	1131	1180	1258	1307	1367
ERW482127-2	1062	1114	1164	1215	1296	1346	1408

24" HIGH	A	B	C	D	E	F	G
ERW302427	934	979	1023	1067	1182	1182	1235
ERW332427	973	1019	1066	1112	1232	1232	1287
ERW362427	1010	1059	1106	1231	1279	1279	1336
ERW372427	1024	1074	1122	1170	1248	1297	1356
ERW392427	1040	1090	1139	1189	1269	1318	1378
ERW422427	1070	1121	1172	1224	1304	1356	1417
ERW482427-2	1100	1153	1205	1258	1342	1395	1458

27" HIGH	A	B	C	D	E	F	G
ERW302727	977	1023	1070	1116	1191	1237	1292
ERW332727	1021	1070	1118	1167	1244	1293	1351
ERW362727	1065	1116	1166	1217	1298	1350	1411
ERW372727	1086	1137	1188	1240	1323	1377	1439
ERW392727	1106	1160	1213	1265	1350	1402	1466
ERW422727	1149	1204	1259	1314	1402	1457	1523
ERW482727-2	1192	1249	1307	1364	1455	1512	1581

# ELAN WALL CABINETS

## REFRIGERATOR WALL

**30", 33" & 36" HIGH**

**27" DEEP**

- 2 Adjustable Shelves

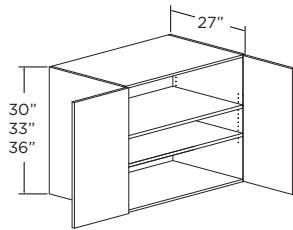

### BUTT DOORS

30"W - 37"W

### DOUBLE DOORS

39"W - 48-2"W

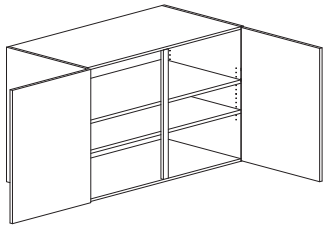

30" HIGH	A	B	C	D	E	F	G
ERW303027	1020	1069	1118	1167	1245	1293	1350
ERW333027	1067	1118	1168	1219	1300	1351	1412
ERW363027	1113	1166	1218	1272	1356	1411	1475
ERW373027	1135	1188	1241	1296	1383	1439	1504
ERW393027	1156	1212	1268	1322	1412	1465	1533
ERW423027	1201	1258	1316	1373	1466	1523	1592
ERW483027-2	1246	1305	1366	1426	1521	1580	1653

33" HIGH	A	B	C	D	E	F	G
ERW303327	1066	1117	1168	1219	1301	1351	1411
ERW333327	1171	1228	1283	1429	1429	1485	1553
ERW363327	1222	1281	1338	1491	1491	1551	1621
ERW373327	1247	1305	1364	1424	1520	1583	1654
ERW393327	1269	1331	1393	1453	1552	1611	1685
ERW423327	1319	1383	1447	1509	1612	1675	1751
ERW483327-2	1369	1435	1501	1568	1673	1738	1818

36" HIGH	A	B	C	D	E	F	G
ERW303627	1114	1167	1220	1274	1360	1412	1475
ERW333627	1224	1283	1341	1400	1553	1553	1623
ERW363627	1277	1338	1399	1461	1622	1622	1695
ERW373627	1303	1364	1426	1489	1655	1655	1729
ERW393627	1327	1392	1456	1519	1684	1684	1762
ERW423627	1379	1445	1512	1578	1751	1751	1831
ERW483627-2	1431	1500	1569	1639	1817	1817	1901

# ELAN WALL CABINETS

## SPLIT WALL 42", 48", 54", 57" & 60" HIGH

- 2 Adjustable Shelves
- To change the top opening, specify Custom Frame Arrangement and the height of the opening.

## SINGLE DOOR

- Specify Hinge (L or R)
- 9"W - 24-1"W

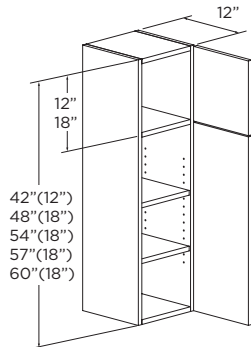

## BUTT DOORS

24-2"W - 36"W

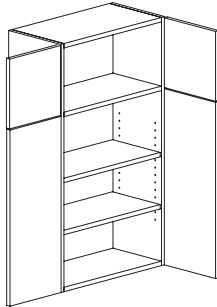

42" HIGH	A	B	C	D	E	F	G
Top Section: 12", 2 Adjustable Shelves							
ESW942	834	877	918	960	1026	1067	1117
ESW1242	897	943	988	1033	1104	1149	1203
ESW1542	1022	1073	1125	1176	1258	1309	1370
ESW1842	1037	1089	1141	1193	1276	1328	1390
ESW2142	1117	1174	1230	1286	1375	1430	1498
ESW2442-1	1178	1238	1297	1356	1450	1509	1579
ESW2442-2	1540	1617	1694	1771	1895	1972	2065
ESW2742	1622	1704	1785	1867	1996	2077	2175
ESW3042	1685	1769	1853	1938	2072	2156	2258
ESW3342	1759	1847	1935	2023	2164	2252	2358
ESW3642	1820	1912	2002	2094	2240	2330	2440

48" HIGH	A	B	C	D	E	F	G
Top Section: 18", 2 Adjustable Shelves							
ESW948	1110	1166	1221	1277	1365	1420	1486
ESW1248	1193	1254	1314	1374	1468	1528	1600
ESW1548	1359	1427	1497	1564	1674	1741	1822
ESW1848	1379	1448	1518	1587	1697	1767	1848
ESW2148	1486	1561	1636	1711	1828	1902	1992
ESW2448-1	1567	1647	1725	1804	1929	2008	2100
ESW2448-2	2049	2151	2254	2356	2521	2622	2747
ESW2748	2157	2267	2374	2483	2655	2764	2893
ESW3048	2241	2354	2464	2577	2756	2869	3003
ESW3348	2340	2457	2575	2691	2880	2995	3138
ESW3648	2422	2543	2663	2785	2980	3100	3245

54" HIGH	A	B	C	D	E	F	G
Top Section: 18", 2 Adjustable Shelves							
ESW954	1490	1566	1640	1715	1833	1906	1996
ESW1254	1602	1684	1765	1846	1972	2053	2149
ESW1554	1825	1916	2010	2100	2248	2338	2447
ESW1854	1852	1945	2038	2132	2280	2373	2482
ESW2154	1995	2097	2197	2298	2455	2554	2676
ESW2454-1	2105	2212	2316	2422	2590	2697	2820
ESW2454-2	2751	2889	3028	3164	3386	3522	3689
ESW2754	2897	3045	3188	3334	3566	3712	3886
ESW3054	3010	3161	3309	3461	3701	3853	4033
ESW3354	3143	3300	3458	3613	3867	4023	4214
ESW3654	3253	3415	3576	3740	4003	4163	4358

57" HIGH	A	B	C	D	E	F	G
Top Section: 18", 3 Adjustable Shelves							
ESW957	1585	1666	1744	1824	1949	2027	2122
ESW1257	1704	1791	1877	1963	2097	2183	2285
ESW1557	1941	2038	2138	2233	2390	2486	2602
ESW1857	1970	2068	2168	2267	2424	2523	2639
ESW2157	2122	2230	2337	2444	2611	2716	2845
ESW2457-1	2238	2352	2463	2576	2755	2868	2999
ESW2457-2	2926	3072	3220	3364	3601	3745	3923
ESW2757	3081	3238	3390	3546	3792	3947	4132
ESW3057	3201	3361	3519	3680	3936	4097	4289
ESW3357	3342	3509	3677	3842	4113	4278	4481
ESW3657	3459	3632	3803	3977	4257	4427	4634

60" HIGH	A	B	C	D	E	F	G
Top Section: 18", 3 Adjustable Shelves							
ESW960	1675	1761	1843	1928	2060	2143	2243
ESW1260	1801	1893	1984	2074	2216	2307	2415
ESW1560	2051	2154	2260	2361	2527	2628	2751
ESW1860	2082	2186	2291	2396	2562	2667	2790
ESW2160	2242	2357	2470	2583	2760	2871	3007
ESW2460-1	2366	2486	2603	2723	2912	3031	3170
ESW2460-2	3093	3247	3403	3556	3806	3958	4147
ESW2760	3257	3423	3584	3748	4008	4172	4367
ESW3060	3384	3553	3720	3890	4160	4331	4533
ESW3360	3532	3709	3887	4061	4347	4521	4736
ESW3660	3656	3839	4019	4204	4499	4680	4898

**DESIGN NOTES:** Height modifications affect the lower section only unless otherwise specified.

# ELAN WALL CABINETS

## WALL WITH TAMBOUR DOOR 48" & 54" HIGH

- 2 Adjustable Shelves
- Tambour Door is not available in foil. For Foil doors, tambour will be Birch Natural unless a wood/finish is specified.
- Tambour clearance height 16-1/4"

### SINGLE DOOR

- Specify Hinge (L or R)
- 15"W - 24-1"W

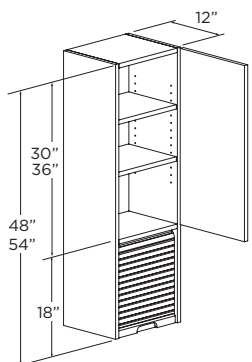

### BUTT DOORS 24-2"W - 36"W

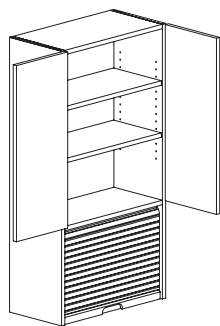

48" HIGH	A	B	C	D	E	F	G
EWT1548	995	1045	1095	1145	1225	1274	1334
EWT1848	1120	1176	1232	1289	1378	1434	1501
EWT2148	1240	1302	1364	1427	1526	1587	1661
EWT2448-1	1350	1418	1485	1553	1660	1729	1809
EWT2448-2	1485	1560	1634	1709	1828	1902	1991
EWT2748	1604	1685	1765	1845	1973	2054	2150
EWT3048	1716	1803	1889	1974	2111	2198	2301
EWT3348	1831	1923	2015	2106	2253	2345	2455
EWT3648	1944	2042	2138	2236	2391	2489	2605

54" HIGH	A	B	C	D	E	F	G
EWT1554	1336	1403	1471	1537	1644	1712	1791
EWT1854	1421	1493	1564	1634	1748	1819	1905
EWT2154	1515	1590	1666	1742	1863	1939	2031
EWT2454-1	1600	1681	1760	1841	1969	2049	2145
EWT2454-2	1694	1780	1864	1949	2084	2170	2271
EWT2754	1764	1853	1941	2029	2170	2259	2364
EWT3054	1819	1911	2001	2093	2238	2329	2438
EWT3354	1903	1999	2094	2189	2342	2436	2551
EWT3654	1971	2070	2169	2267	2424	2523	2642

## WALL WITH TAMBOUR DOOR 57" & 60" HIGH

- 3 Adjustable Shelves
- Tambour Door is not available in foil. For Foil doors, tambour will be Birch Natural unless a wood/finish is specified.
- Tambour clearance height 16-1/4"

### SINGLE DOOR

- Specify Hinge (L or R)
- 15"W - 24-1"W

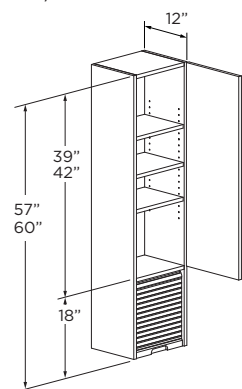

### BUTT DOORS 24-2"W - 36"W

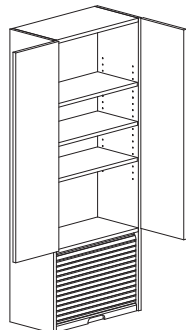

57" HIGH	A	B	C	D	E	F	G
EWT1557	1412	1483	1554	1625	1737	1808	1892
EWT1857	1500	1576	1650	1726	1846	1921	2011
EWT2157	1601	1682	1762	1842	1970	2049	2146
EWT2457-1	1688	1774	1858	1943	2077	2161	2263
EWT2457-2	1785	1874	1963	2053	2196	2285	2392
EWT2757	1861	1955	2048	2141	2290	2383	2494
EWT3057	1921	2017	2114	2209	2363	2458	2575
EWT3357	2006	2108	2208	2308	2468	2568	2688
EWT3657	2082	2187	2291	2395	2561	2665	2791

60" HIGH	A	B	C	D	E	F	G
EWT1560	1473	1548	1621	1694	1813	1886	1974
EWT1860	1577	1656	1735	1814	1940	2020	2114
EWT2160	1682	1767	1851	1935	2070	2154	2254
EWT2460-1	1776	1866	1955	2043	2186	2274	2381
EWT2460-2	1880	1974	2068	2163	2313	2407	2520
EWT2760	1955	2053	2150	2248	2405	2502	2620
EWT3060	2023	2125	2226	2328	2489	2590	2712
EWT3360	2115	2221	2326	2433	2601	2708	2835
EWT3660	2191	2301	2411	2520	2696	2804	2936

**DESIGN NOTES:** Height modifications affect the upper section only unless otherwise specified.

# ELAN WALL CABINETS

## WALL WITH APPLIANCE GARAGE 48" & 54" HIGH

- 2 Adjustable Shelves
- Lower section clearance height 17-13/16"

### SINGLE DOOR

- Specify Hinge (L or R)
- 15"W - 24-1"W

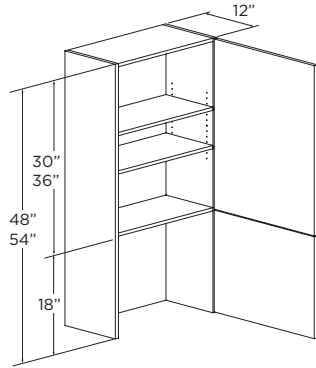

### BUTT DOORS

24-2"W - 36"W

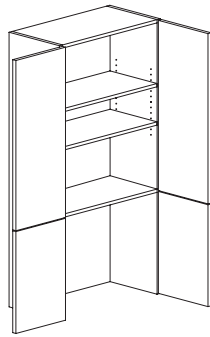

48" HIGH	A	B	C	D	E	F	G
EWAG1548	1178	1238	1297	1356	1450	1509	1579
EWAG1848	1259	1323	1385	1449	1549	1612	1688
EWAG2148	1339	1406	1473	1540	1647	1714	1795
EWAG2448-1	1412	1483	1554	1625	1737	1808	1892
EWAG2448-2	1504	1579	1654	1730	1850	1925	2016
EWAG2748	1564	1642	1720	1798	1924	2002	2095
EWAG3048	1615	1697	1778	1858	1987	2067	2165
EWAG3348	1688	1774	1858	1943	2077	2161	2263
EWAG3648	1764	1854	1943	2030	2171	2258	2365

54" HIGH	A	B	C	D	E	F	G
EWAG1554	1325	1392	1458	1524	1631	1697	1776
EWAG1854	1421	1493	1564	1634	1748	1819	1905
EWAG2154	1515	1590	1666	1742	1863	1939	2031
EWAG2454-1	1600	1681	1760	1841	1969	2049	2145
EWAG2454-2	1694	1780	1864	1949	2084	2170	2271
EWAG2754	1764	1853	1941	2029	2170	2259	2364
EWAG3054	1819	1911	2001	2093	2238	2329	2438
EWAG3354	1903	1999	2094	2189	2342	2436	2551
EWAG3654	1989	2091	2191	2290	2451	2549	2668

## WALL WITH APPLIANCE GARAGE 57" & 60" HIGH

- 3 Adjustable Shelves
- Lower section clearance height 17-13/16"

### SINGLE DOOR

- Specify Hinge (L or R)
- 15"W - 24-1"W

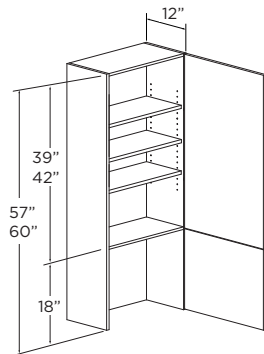

### BUTT DOORS

24-2"W - 36"W

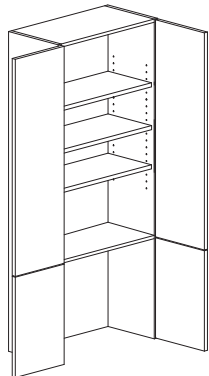

57" HIGH	A	B	C	D	E	F	G
EWAG1557	1402	1473	1543	1614	1725	1796	1879
EWAG1857	1500	1576	1650	1726	1846	1921	2011
EWAG2157	1598	1678	1758	1839	1966	2045	2142
EWAG2457-1	1688	1774	1858	1943	2077	2161	2263
EWAG2457-2	1785	1874	1963	2053	2196	2285	2392
EWAG2757	1861	1955	2048	2141	2290	2383	2494
EWAG3057	1921	2017	2114	2209	2363	2458	2575
EWAG3357	2006	2108	2208	2308	2468	2568	2688
EWAG3657	2096	2203	2309	2412	2580	2683	2809

60" HIGH	A	B	C	D	E	F	G
EWAG1560	1473	1548	1621	1694	1813	1886	1974
EWAG1860	1577	1656	1735	1814	1940	2020	2114
EWAG2160	1682	1767	1851	1935	2070	2154	2254
EWAG2460-1	1776	1866	1955	2043	2186	2274	2381
EWAG2460-2	1880	1974	2068	2163	2313	2407	2520
EWAG2760	1955	2053	2150	2248	2405	2502	2620
EWAG3060	2023	2125	2226	2328	2489	2590	2712
EWAG3360	2115	2221	2326	2433	2601	2708	2835
EWAG3660	2210	2321	2432	2544	2718	2832	2964

**DESIGN NOTES:** Height modifications affect the upper section only unless otherwise specified.

# ELAN WALL CABINETS

## WALL WITH LIFT UP APPLIANCE GARAGE 48", 54", 57" & 60" HIGH

- Butt door cabinets have single lift door with two vertical grain panels.
- Minimum cabinet depth: 12"
- Interior clearance height is 17"
- Usable interior width is opening width less 3"
- Aventos HL Hardware

### SINGLE DOOR

- Specify Hinge (L or R)
- 15"W - 24-1"W

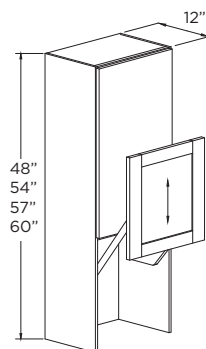

### BUTT DOORS

24-2"W - 36"W

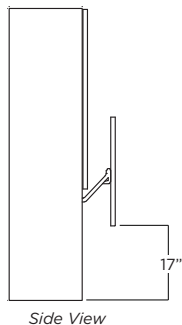
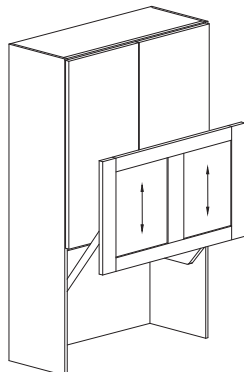

48" HIGH	A	B	C	D	E	F	G
2 Adjustable Shelves							
EWAGLUA1548	1828	1888	1947	2006	2100	2159	2229
EWAGLUA1848	1909	1973	2035	2099	2199	2262	2338
EWAGLUA2148	1989	2056	2123	2190	2297	2364	2445
EWAGLUA2448-1	2062	2133	2204	2275	2387	2458	2542
EWAGLUA2448-2	2154	2229	2304	2380	2500	2575	2666
EWAGLUA2748	2214	2292	2370	2448	2574	2652	2745
EWAGLUA3048	2265	2347	2428	2508	2637	2717	2815
EWAGLUA3348	2338	2424	2508	2593	2727	2811	2913
EWAGLUA3648	2414	2504	2593	2680	2821	2908	3015

54" HIGH	A	B	C	D	E	F	G
2 Adjustable Shelves							
EWAGLUA1554	1975	2042	2108	2174	2281	2347	2426
EWAGLUA1854	2071	2143	2214	2284	2398	2469	2555
EWAGLUA2154	2165	2240	2316	2392	2513	2589	2681
EWAGLUA2454-1	2250	2331	2410	2491	2619	2699	2795
EWAGLUA2454-2	2344	2430	2514	2599	2734	2820	2921
EWAGLUA2754	2414	2503	2591	2679	2820	2909	3014
EWAGLUA3054	2469	2561	2651	2743	2888	2979	3088
EWAGLUA3354	2553	2649	2744	2839	2992	3086	3201
EWAGLUA3654	2639	2741	2841	2940	3101	3199	3318

57" HIGH	A	B	C	D	E	F	G
3 Adjustable Shelves							
EWAGLUA1557	2052	2123	2193	2264	2375	2446	2529
EWAGLUA1857	2150	2226	2300	2376	2496	2571	2661
EWAGLUA2157	2248	2328	2408	2489	2616	2695	2792
EWAGLUA2457-1	2338	2424	2508	2593	2727	2811	2913
EWAGLUA2457-2	2435	2524	2613	2703	2846	2935	3042
EWAGLUA2757	2511	2605	2698	2791	2940	3033	3144
EWAGLUA3057	2571	2667	2764	2859	3013	3108	3225
EWAGLUA3357	2656	2758	2858	2958	3118	3218	3338
EWAGLUA3657	2746	2853	2959	3062	3230	3333	3459

60" HIGH	A	B	C	D	E	F	G
3 Adjustable Shelves							
EWAGLUA1560	2123	2198	2271	2344	2463	2536	2624
EWAGLUA1860	2227	2306	2385	2464	2590	2670	2764
EWAGLUA2160	2332	2417	2501	2585	2720	2804	2904
EWAGLUA2460-1	2426	2516	2605	2693	2836	2924	3031
EWAGLUA2460-2	2530	2624	2718	2813	2963	3057	3170
EWAGLUA2760	2605	2703	2800	2898	3055	3152	3270
EWAGLUA3060	2673	2775	2876	2978	3139	3240	3362
EWAGLUA3360	2765	2871	2976	3083	3251	3358	3485
EWAGLUA3660	2860	2971	3082	3194	3368	3482	3614

**DESIGN NOTES:** Height modifications affect the upper section only unless otherwise specified.



# ELAN WALL CABINETS

## WALL WITH 1 DRAWER 48" & 54" HIGH

- 3 Adjustable Shelves
- Minimum cabinet depth: 12"

### SINGLE DOOR

- Specify Hinge (L or R)
- 15"W - 24-1"W

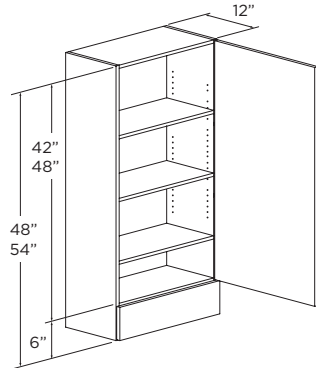

### BUTT DOORS

24-2"W - 36"W

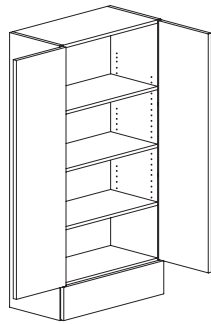

48" HIGH	A	B	C	D	E	F	G
EWID1548	884	929	973	1017	1088	1132	1185
EWID1848	919	966	1012	1057	1131	1177	1232
EWID2148	961	1010	1057	1105	1182	1231	1289
EWID2448-1	1001	1051	1101	1152	1232	1282	1342
EWID2448-2	1060	1114	1166	1220	1304	1357	1421
EWID2748	1154	1213	1270	1328	1421	1478	1546
EWID3048	1251	1314	1377	1439	1539	1601	1676
EWID3348	1307	1373	1438	1504	1608	1674	1752
EWID3648	1363	1432	1500	1568	1677	1746	1828

54" HIGH	A	B	C	D	E	F	G
EWID1554	1105	1161	1216	1271	1359	1416	1482
EWID1854	1139	1197	1254	1311	1402	1458	1527
EWID2154	1148	1205	1263	1320	1412	1469	1539
EWID2454-1	1155	1214	1271	1329	1422	1479	1549
EWID2454-2	1219	1280	1341	1402	1500	1561	1633
EWID2754	1333	1400	1466	1533	1639	1707	1786
EWID3054	1446	1520	1592	1664	1780	1852	1939
EWID3354	1512	1588	1664	1740	1861	1936	2027
EWID3654	1579	1659	1738	1817	1944	2022	2117

## WALL WITH 1 DRAWER 57" & 60" HIGH

- 4 Adjustable Shelves
- Minimum cabinet depth: 12"

### SINGLE DOOR

- Specify Hinge (L or R)
- 15"W - 24-1"W

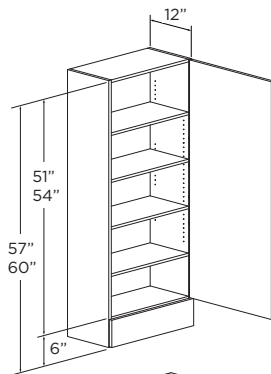

### BUTT DOORS

24-2"W - 36"W

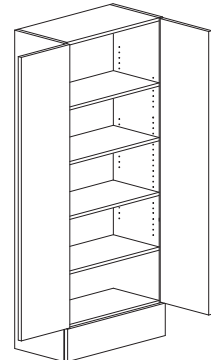

57" HIGH	A	B	C	D	E	F	G
EWID1557	1153	1211	1269	1326	1418	1477	1545
EWID1857	1178	1238	1297	1356	1450	1509	1579
EWID2157	1203	1264	1324	1384	1480	1540	1612
EWID2457-1	1226	1289	1350	1411	1509	1570	1644
EWID2457-2	1287	1352	1417	1480	1584	1648	1726
EWID2757	1392	1462	1532	1601	1713	1782	1867
EWID3057	1498	1573	1648	1723	1842	1917	2007
EWID3357	1557	1636	1714	1792	1917	1994	2088
EWID3657	1620	1702	1782	1863	1993	2073	2171

60" HIGH	A	B	C	D	E	F	G
EWID1560	1183	1243	1302	1362	1456	1516	1587
EWID1860	1216	1278	1339	1400	1496	1557	1631
EWID2160	1258	1322	1384	1447	1548	1611	1686
EWID2460-1	1297	1363	1428	1493	1597	1661	1738
EWID2460-2	1357	1425	1493	1561	1670	1737	1819
EWID2760	1451	1524	1597	1670	1786	1858	1945
EWID3060	1548	1626	1703	1780	1905	1982	2075
EWID3360	1611	1692	1773	1853	1983	2064	2160
EWID3660	1658	1741	1824	1907	2039	2122	2223

**DESIGN NOTES:** Height modifications affect the upper section only unless otherwise specified.

# ELAN WALL CABINETS

## WALL WITH 2 DRAWER 48" HIGH

- 2 Adjustable Shelves
- Minimum cabinet depth: 12"

### SINGLE DOOR

- Specify Hinge (L or R)
- 18"W - 24-1"W

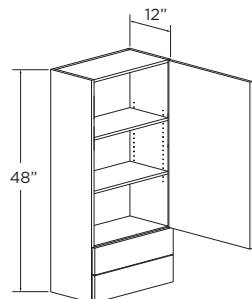

48" HIGH	A	B	C	D	E	F	G
EW2D1548	1006	1057	1107	1158	1238	1288	1349
EW2D1848	1046	1099	1151	1203	1288	1339	1402
EW2D2148	1093	1149	1203	1257	1345	1401	1467
EW2D2448-1	1139	1196	1253	1311	1402	1459	1527
EW2D2448-2	1206	1268	1327	1388	1485	1544	1618
EW2D2748	1314	1381	1446	1512	1617	1682	1760
EW2D3048	1424	1495	1567	1637	1751	1823	1908
EW2D3348	1488	1563	1636	1711	1830	1905	1994
EW2D3648	1551	1630	1708	1785	1908	1987	2081

### BUTT DOORS

24-2"W - 36"W

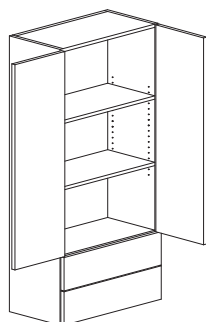

## WALL WITH 2 DRAWER 54", 57" & 60" HIGH

- 3 Adjustable Shelves
- Minimum cabinet depth: 12"

### SINGLE DOOR

- Specify Hinge (L or R)
- 18"W - 24-1"W

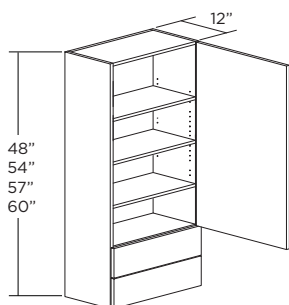

54" HIGH	A	B	C	D	E	F	G
EW2D1554	1246	1310	1371	1434	1534	1598	1672
EW2D1854	1285	1350	1415	1478	1581	1645	1723
EW2D2154	1295	1360	1425	1489	1594	1657	1736
EW2D2454-1	1303	1369	1434	1499	1605	1669	1747
EW2D2454-2	1376	1444	1512	1582	1691	1761	1842
EW2D2754	1504	1579	1655	1729	1849	1925	2015
EW2D3054	1631	1715	1797	1877	2008	2090	2188
EW2D3354	1706	1792	1878	1964	2100	2184	2286
EW2D3654	1782	1872	1960	2050	2193	2281	2389

57" HIGH	A	B	C	D	E	F	G
EW2D1557	1300	1365	1430	1494	1598	1665	1741
EW2D1857	1327	1395	1462	1529	1635	1700	1780
EW2D2157	1356	1424	1492	1559	1668	1736	1817
EW2D2457-1	1382	1453	1522	1591	1701	1769	1854
EW2D2457-2	1451	1524	1597	1669	1786	1857	1946
EW2D2757	1569	1647	1726	1805	1931	2008	2105
EW2D3057	1688	1772	1857	1943	2075	2161	2262
EW2D3357	1756	1843	1932	2020	2160	2247	2354
EW2D3657	1826	1919	2009	2099	2247	2337	2447

60" HIGH	A	B	C	D	E	F	G
EW2D1560	1332	1400	1467	1534	1639	1708	1787
EW2D1860	1369	1439	1508	1577	1685	1754	1837
EW2D2160	1417	1489	1559	1629	1744	1815	1899
EW2D2460-1	1461	1535	1607	1681	1798	1870	1958
EW2D2460-2	1528	1604	1681	1758	1880	1956	2049
EW2D2760	1633	1717	1799	1882	2012	2093	2191
EW2D3060	1743	1832	1918	2004	2145	2233	2337
EW2D3360	1814	1905	1996	2086	2233	2324	2433
EW2D3660	1867	1960	2054	2148	2295	2390	2503

### BUTT DOORS

24-2"W - 36"W

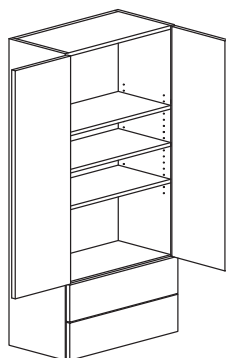

**DESIGN NOTES:** Height modifications affect the upper section only unless otherwise specified.

## WALL WITH 3 DRAWER 48" & 54" HIGH

- 2 Adjustable Shelves
- Minimum cabinet depth: 12"

### SINGLE DOOR

- Specify Hinge (L or R)
- 15"W - 24-1"W

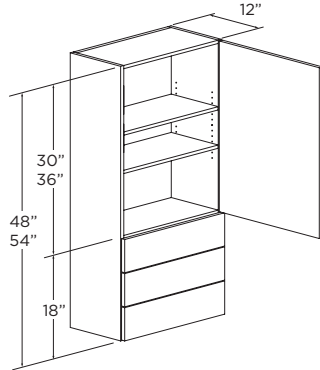

### BUTT DOORS

24-2"W - 36"W

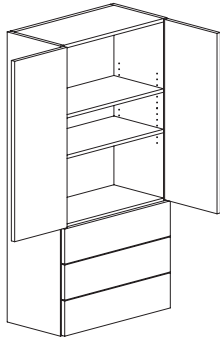

48" HIGH	A	B	C	D	E	F	G
EW3D1548	1127	1185	1241	1297	1388	1444	1511
EW3D1848	1175	1235	1293	1352	1446	1505	1575
EW3D2148	1223	1284	1345	1406	1504	1565	1638
EW3D2448-1	1269	1333	1396	1460	1561	1625	1700
EW3D2448-2	1337	1405	1472	1539	1645	1713	1792
EW3D2748	1450	1523	1595	1667	1784	1857	1944
EW3D3048	1562	1641	1719	1797	1922	2000	2094
EW3D3348	1625	1707	1787	1869	1999	2081	2177
EW3D3648	1696	1781	1866	1951	2087	2171	2273

54" HIGH	A	B	C	D	E	F	G
EW3D1554	1412	1483	1554	1625	1737	1808	1892
EW3D1854	1432	1504	1576	1647	1762	1833	1919
EW3D2154	1443	1515	1587	1659	1775	1847	1934
EW3D2454-1	1451	1524	1597	1670	1786	1858	1945
EW3D2454-2	1526	1603	1678	1756	1878	1954	2045
EW3D2754	1633	1715	1797	1879	2010	2092	2189
EW3D3054	1793	1884	1973	2064	2207	2296	2403
EW3D3354	1875	1969	2064	2158	2307	2401	2513
EW3D3654	1951	2049	2147	2245	2401	2498	2615

## WALL WITH 3 DRAWER 57" & 60" HIGH

- 3 Adjustable Shelves
- Minimum cabinet depth: 12"

### SINGLE DOOR

- Specify Hinge (L or R)
- 15"W - 24-1"W

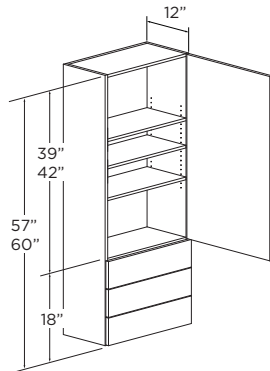

### BUTT DOORS

24-2"W - 36"W

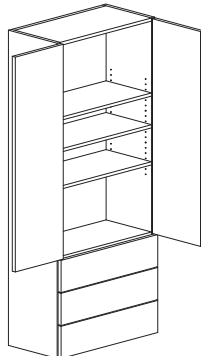

57" HIGH	A	B	C	D	E	F	G
EW3D1557	1450	1523	1595	1667	1784	1857	1944
EW3D1857	1478	1553	1626	1700	1819	1892	1982
EW3D2157	1505	1581	1656	1731	1852	1927	2017
EW3D2457-1	1533	1610	1687	1764	1886	1963	2055
EW3D2457-2	1606	1687	1768	1848	1977	2056	2153
EW3D2757	1729	1815	1902	1989	2127	2213	2317
EW3D3057	1851	1944	2037	2130	2278	2369	2480
EW3D3357	1923	2020	2116	2212	2366	2462	2577
EW3D3657	1995	2095	2196	2295	2455	2554	2674

60" HIGH	A	B	C	D	E	F	G
EW3D1560	1467	1540	1614	1687	1804	1878	1966
EW3D1860	1524	1601	1677	1754	1875	1952	2043
EW3D2160	1571	1650	1729	1807	1933	2011	2105
EW3D2460-1	1617	1699	1780	1861	1990	2401	2167
EW3D2460-2	1688	1774	1858	1943	2077	2161	2263
EW3D2760	1800	1890	1980	2070	2214	2304	2412
EW3D3060	1911	2007	2103	2198	2351	2446	2561
EW3D3360	1955	2053	2150	2248	2405	2502	2620
EW3D3660	2043	2145	2248	2350	2513	2615	2738

**DESIGN NOTES:** Height modifications affect the upper section only unless otherwise specified.





**TABLE OF CONTENTS**

**ELAN CORNER WALL CABINETS.....E200-1 THRU E200-12**

Blind Corner Wall Cabinets..... E200-2 thru E200-3  
Blind Corner Split Wall..... E200-4  
Square Corner Wall Cabinets..... E200-5  
Diagonal Corner Wall Cabinets..... E200-6  
Diagonal Corner Split Wall..... E200-7  
Diagonal Corner Wall with Tambour Door..... E200-7  
Diagonal Corner Wall with Appliance Garage..... E200-8  
Diagonal Corner Wall With Lift Up Appliance Garage..... E200-9  
Peninsula Blind Corner Wall..... E200-10 thru E200-11  
Peninsula Square Corner Wall Cabinet..... E200-12  
Peninsula Diagonal Corner Wall ..... E200-12  
Peninsula Diagonal Corner Split Wall..... E200-12



# ELAN WALL CORNER CABINETS

## BLIND CORNER WALL CABINETS 24", 30", 33", 36" & 39" HIGH

- On Single Door Cabinets the Door is Hinged on the Blind Side.
- Specify Which Side is Blind Left (BL) or Right (BR). Shown BR.
- 15" blind panel. Cabinet does not need to be pulled from the corner but can be for additional clearance if needed.

### SINGLE DOOR

- Door Hinged on Blind Side
- 24"W - 36"W

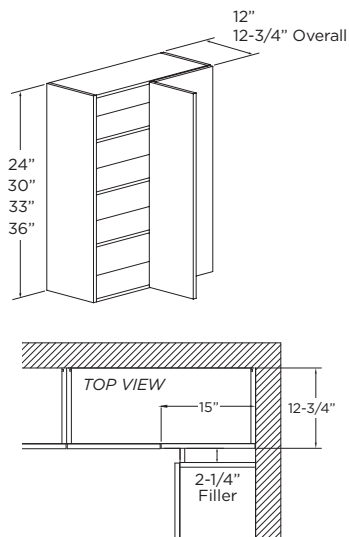

### BUTT DOORS

39"W - 48"W

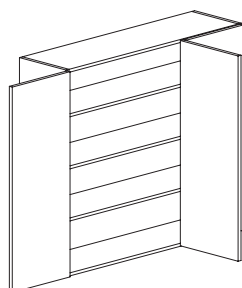

CABINET WIDTH	DOOR SECTION WIDTH	BLIND WIDTH
24"	9"	15"
27"	12"	15"
30"	15"	15"
33"	18"	15"
36"	21"	15"
39"	24"	15"
42"	27"	15"
45"	30"	15"
48"	33"	15"

24" HIGH	A	B	C	D	E	F	G
1 Adjustable Shelf							
EBCW2424	633	665	697	729	780	812	850
EBCW2724	661	694	729	762	814	847	886
EBCW3024	691	725	760	795	850	885	927
EBCW3324	716	752	789	824	881	918	961
EBCW3624	745	781	819	857	917	954	999
EBCW3924	873	917	961	1005	1075	1117	1170
EBCW4224	902	947	993	1038	1110	1155	1209
EBCW4524	932	978	1026	1072	1147	1193	1249
EBCW4824	960	1007	1056	1104	1181	1229	1286

30" HIGH	A	B	C	D	E	F	G
2 Adjustable Shelves							
EBCW2430	707	742	778	813	869	905	947
EBCW2730	746	784	820	858	918	955	1000
EBCW3030	779	818	857	896	958	998	1044
EBCW3330	814	855	896	936	1002	1043	1092
EBCW3630	848	891	934	977	1044	1087	1137
EBCW3930	944	991	1039	1086	1161	1209	1265
EBCW4230	1001	1051	1101	1152	1232	1282	1342
EBCW4530	1031	1082	1134	1186	1268	1320	1381
EBCW4830	1068	1122	1176	1230	1315	1368	1433

33" HIGH	A	B	C	D	E	F	G
2 Adjustable Shelves							
EBCW2433	719	755	791	827	884	921	963
EBCW2733	758	797	834	873	933	971	1017
EBCW3033	792	832	872	911	974	1015	1062
EBCW3333	828	869	911	952	1019	1061	1110
EBCW3633	862	906	950	994	1062	1105	1156
EBCW3933	960	1008	1057	1104	1181	1229	1287
EBCW4233	1018	1069	1120	1171	1253	1304	1365
EBCW4533	1048	1101	1154	1206	1290	1343	1405
EBCW4833	1086	1142	1196	1251	1338	1392	1458

36" HIGH	A	B	C	D	E	F	G
2 Adjustable Shelves							
EBCW2436	770	808	847	886	947	987	1033
EBCW2736	815	856	897	939	1004	1044	1093
EBCW3036	852	895	938	980	1049	1092	1142
EBCW3336	890	934	979	1024	1095	1139	1193
EBCW3636	927	973	1020	1066	1141	1187	1242
EBCW3936	1050	1103	1155	1208	1292	1345	1408
EBCW4236	1079	1133	1188	1242	1329	1383	1447
EBCW4536	1108	1163	1219	1274	1363	1418	1485
EBCW4836	1137	1193	1251	1308	1399	1456	1524

39" HIGH	A	B	C	D	E	F	G
3 Adjustable Shelves							
EBCW2439	782	822	861	900	963	1002	1049
EBCW2739	850	892	935	978	1045	1088	1139
EBCW3039	890	934	979	1024	1095	1139	1193
EBCW3339	930	977	1024	1071	1145	1192	1247
EBCW3639	969	1018	1067	1115	1193	1242	1300
EBCW3939	998	1048	1098	1148	1227	1278	1337
EBCW4239	1027	1078	1130	1181	1264	1315	1377
EBCW4539	1064	1117	1170	1224	1309	1362	1425
EBCW4839	1097	1152	1207	1262	1350	1405	1469

# ELAN WALL CORNER CABINETS

## BLIND CORNER WALL 42", 48", 54", 57" & 60" HIGH

- On Single Door Cabinets the Door is Hinged on the Blind Side.
- Specify Which Side is Blind Left (BL) or Right (BR). Shown BR.
- 15" blind panel. Cabinet does not need to be pulled from the corner but can be for additional clearance if needed.

### SINGLE DOOR

- Door Hinged on Blind Side
- 24"W - 36"W

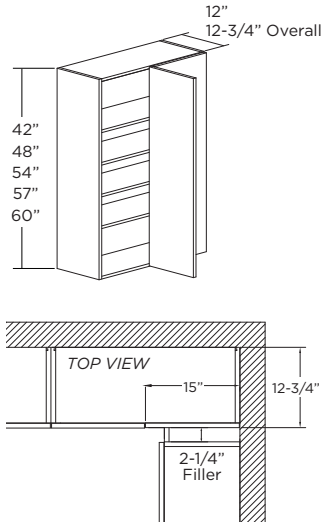

### BUTT DOORS

39"W - 48"W

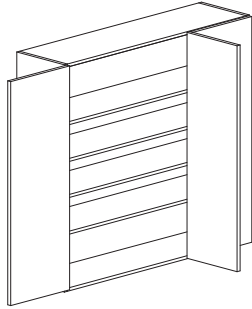

CABINET WIDTH	DOOR SECTION WIDTH	BLIND WIDTH
24"	9"	15"
27"	12"	15"
30"	15"	15"
33"	18"	15"
36"	21"	15"
39"	24"	15"
42"	27"	15"
45"	30"	15"
48"	33"	15"

**DESIGN NOTES:** Doors will be constructed with a horizontal center rail and equally sized panels over 48" high.

42" HIGH	A	B	C	D	E	F	G
3 Adjustable Shelves							
EBCW2442	795	835	874	914	978	1017	1065
EBCW2742	881	925	971	1015	1084	1128	1182
EBCW3042	925	972	1018	1065	1139	1185	1241
EBCW3342	968	1017	1066	1114	1192	1240	1298
EBCW3642	1012	1062	1114	1165	1246	1296	1357
EBCW3942	1218	1279	1340	1401	1499	1559	1632
EBCW4242	1284	1348	1412	1477	1579	1643	1720
EBCW4542	1325	1391	1458	1524	1631	1697	1776
EBCW4842	1359	1428	1496	1564	1672	1741	1823

48" HIGH	A	B	C	D	E	F	G
3 Adjustable Shelves							
EBCW2448	887	932	976	1020	1091	1135	1189
EBCW2748	983	1033	1083	1133	1210	1259	1320
EBCW3048	1033	1085	1136	1188	1271	1323	1385
EBCW3348	1080	1135	1190	1243	1330	1384	1448
EBCW3648	1130	1185	1243	1300	1390	1447	1514
EBCW3948	1360	1428	1495	1564	1674	1741	1822
EBCW4248	1433	1505	1576	1648	1762	1835	1920
EBCW4548	1479	1553	1628	1701	1820	1893	1982
EBCW4848	1516	1594	1670	1745	1866	1943	2035

54" HIGH	A	B	C	D	E	F	G
4 Adjustable Shelves							
EBCW2454	990	1040	1089	1139	1218	1267	1327
EBCW2754	1097	1152	1209	1264	1350	1405	1473
EBCW3054	1152	1211	1268	1326	1418	1476	1545
EBCW3354	1205	1267	1328	1387	1485	1544	1616
EBCW3654	1261	1322	1387	1451	1551	1615	1690
EBCW3954	1518	1594	1668	1745	1868	1943	2033
EBCW4254	1600	1680	1759	1839	1967	2047	2143
EBCW4554	1651	1733	1817	1898	2032	2113	2212
EBCW4854	1692	1778	1864	1947	2083	2168	2271

57" HIGH	A	B	C	D	E	F	G
4 Adjustable Shelves							
EBCW2457	1079	1133	1186	1240	1326	1379	1445
EBCW2757	1195	1255	1316	1377	1471	1530	1604
EBCW3057	1255	1319	1381	1444	1544	1608	1683
EBCW3357	1313	1379	1446	1511	1617	1682	1760
EBCW3657	1373	1440	1511	1580	1689	1758	1841
EBCW3957	1653	1735	1817	1900	2034	2115	2214
EBCW4257	1742	1829	1915	2003	2142	2230	2334
EBCW4557	1798	1888	1978	2067	2212	2301	2409
EBCW4857	1843	1937	2030	2121	2268	2361	2473

60" HIGH	A	B	C	D	E	F	G
4 Adjustable Shelves							
EBCW2460	1175	1233	1291	1350	1444	1502	1574
EBCW2760	1301	1367	1433	1499	1602	1666	1746
EBCW3060	1367	1436	1504	1573	1682	1751	1833
EBCW3360	1429	1502	1574	1645	1761	1831	1917
EBCW3660	1495	1568	1645	1720	1840	1915	2004
EBCW3960	1800	1890	1979	2069	2215	2304	2411
EBCW4260	1897	1992	2086	2181	2333	2428	2542
EBCW4560	1958	2056	2154	2251	2409	2506	2623
EBCW4860	2007	2109	2210	2309	2470	2571	2693

# ELAN WALL CORNER CABINETS

## BLIND CORNER SPLIT WALL

- On Single Door Cabinets the Door is Hinged on the Blind Side.
- Specify Which Side is Blind Left (BL) or Right (BR). Shown BR.
- 15" blind panel. Cabinet does not need to be pulled from the corner but can be for additional clearance if needed.

## SINGLE DOOR

- Door Hinged on Blind Side
- 24"W - 36"W

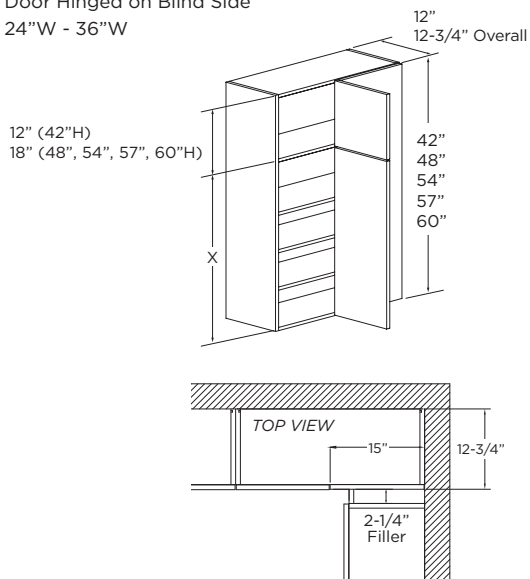

## BUTT DOORS

39"W - 48"W

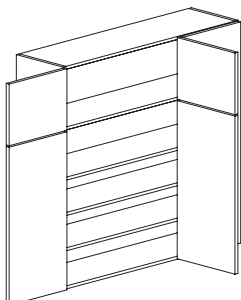

CABINET WIDTH	DOOR SECTION WIDTH	BLIND WIDTH
24"	9"	15"
27"	12"	15"
30"	15"	15"
33"	18"	15"
36"	21"	15"
39"	24"	15"
42"	27"	15"
45"	30"	15"
48"	33"	15"

**DESIGN NOTE:** Height modifications affect the lower section only unless otherwise specified.

42" HIGH	A	B	C	D	E	F	G
2 Adjustable Shelves							
EBCSW2442	1373	1441	1511	1579	1689	1758	1840
EBCSW2742	1499	1573	1649	1724	1844	1919	2009
EBCSW3042	1632	1714	1796	1878	2009	2089	2187
EBCSW3342	1678	1763	1847	1930	2065	2149	2249
EBCSW3642	1808	1899	1989	2079	2225	2315	2423
EBCSW3942	1879	1973	2067	2161	2312	2406	2518
EBCSW4242	1923	2020	2116	2212	2366	2462	2577
EBCSW4542	2000	2100	2201	2301	2461	2561	2681
EBCSW4842	2038	2139	2242	2345	2507	2609	2731

48" HIGH	A	B	C	D	E	F	G
2 Adjustable Shelves							
EBCSW2448	1533	1608	1687	1763	1885	1962	2054
EBCSW2748	1672	1756	1840	1925	2058	2142	2243
EBCSW3048	1821	1912	2004	2096	2243	2331	2440
EBCSW3348	1872	1968	2062	2155	2304	2399	2511
EBCSW3648	2018	2119	2221	2321	2484	2584	2704
EBCSW3948	2097	2202	2308	2411	2581	2686	2810
EBCSW4248	2148	2255	2363	2469	2640	2749	2877
EBCSW4548	2233	2345	2458	2568	2746	2859	2992
EBCSW4848	2276	2387	2502	2616	2798	2913	3049

54" HIGH	A	B	C	D	E	F	G
2 Adjustable Shelves							
EBCSW2454	1711	1795	1883	1967	2103	2190	2292
EBCSW2754	1866	1960	2054	2148	2297	2391	2503
EBCSW3054	2033	2134	2237	2339	2503	2602	2723
EBCSW3354	2090	2196	2302	2405	2572	2677	2802
EBCSW3654	2253	2365	2479	2590	2772	2883	3018
EBCSW3954	2340	2457	2575	2691	2880	2998	3136
EBCSW4254	2397	2516	2637	2756	2947	3068	3211
EBCSW4554	2492	2617	2743	2866	3065	3190	3339
EBCSW4854	2540	2664	2792	2920	3122	3250	3402

57" HIGH	A	B	C	D	E	F	G
3 Adjustable Shelves							
EBCSW2457	1873	1964	2061	2153	2302	2397	2509
EBCSW2757	2043	2145	2248	2351	2514	2617	2739
EBCSW3057	2225	2336	2448	2560	2740	2848	2981
EBCSW3357	2287	2404	2519	2632	2815	2930	3067
EBCSW3657	2466	2589	2713	2835	3034	3156	3303
EBCSW3957	2562	2690	2819	2945	3153	3282	3432
EBCSW4257	2623	2754	2887	3016	3225	3358	3515
EBCSW4557	2728	2865	3002	3137	3354	3492	3655
EBCSW4857	2780	2916	3056	3196	3418	3558	3724

60" HIGH	A	B	C	D	E	F	G
3 Adjustable Shelves							
EBCSW2460	2039	2139	2244	2345	2507	2610	2732
EBCSW2760	2225	2336	2448	2560	2738	2850	2983
EBCSW3060	2423	2544	2666	2788	2984	3101	3246
EBCSW3360	2491	2618	2743	2866	3065	3191	3340
EBCSW3660	2685	2819	2955	3087	3304	3437	3597
EBCSW3960	2790	2929	3070	3208	3433	3574	3738
EBCSW4260	2857	3000	3144	3285	3513	3656	3827
EBCSW4560	2971	3120	3269	3416	3653	3803	3981
EBCSW4860	3027	3176	3328	3481	3722	3874	4055



# ELAN WALL CORNER CABINETS

## SQUARE CORNER WALL CABINET

- Specify Hinge (L or R)
- Decrease Depth Not Available
- For increase or decrease width modifications, specify left, right or both back dimensions.
- 24" Wide Cabinets are 12" Deep
- 27" Wide Cabinets are 15" Deep

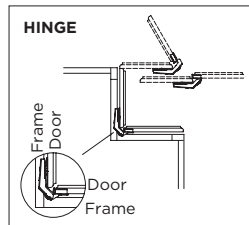
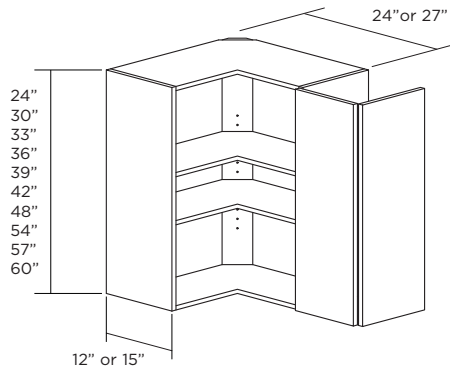

24" HIGH	A	B	C	D	E	F	G
1 Adjustable Shelf							
ESCW2424	803	844	884	924	989	1028	1077
ESCW272415	1071	1125	1178	1232	1318	1372	1435
30" HIGH	A	B	C	D	E	F	G
2 Adjustable Shelves							
ESCW2430	921	967	1013	1059	1133	1178	1235
ESCW273015	1188	1248	1308	1367	1462	1522	1593
33" HIGH	A	B	C	D	E	F	G
2 Adjustable Shelves							
ESCW2433	979	1028	1077	1126	1205	1252	1313
ESCW273315	1249	1312	1375	1436	1537	1600	1675
36" HIGH	A	B	C	D	E	F	G
2 Adjustable Shelves							
ESCW2436	1077	1131	1186	1240	1325	1379	1444
ESCW243615	1344	1411	1478	1545	1653	1720	1801
39" HIGH	A	B	C	D	E	F	G
3 Adjustable Shelves							
ESCW2439	1144	1202	1259	1317	1408	1466	1534
ESCW273915	1412	1483	1554	1625	1737	1808	1892
42" HIGH	A	B	C	D	E	F	G
3 Adjustable Shelves							
ESCW2442	1210	1271	1331	1392	1489	1550	1622
ESCW274215	1479	1553	1627	1702	1820	1894	1983
48" HIGH	A	B	C	D	E	F	G
3 Adjustable Shelves							
ESCW2448	1363	1431	1500	1567	1677	1746	1828
ESCW274815	1665	1749	1833	1917	2049	2133	2233
54" HIGH	A	B	C	D	E	F	G
4 Adjustable Shelves							
ESCW2454	1544	1621	1699	1776	1900	1978	2071
ESCW275415	1885	1979	2074	2169	2319	2414	2527
57" HIGH	A	B	C	D	E	F	G
4 Adjustable Shelves							
ESCW2457	1739	1826	1913	1999	2140	2227	2332
ESCW275715	2122	2228	2335	2442	2612	2719	2846
60" HIGH	A	B	C	D	E	F	G
4 Adjustable Shelves							
ESCW2460	1958	2056	2155	2251	2409	2508	2625
ESCW276015	2390	2509	2630	2750	2941	3061	3204

**DESIGN NOTES:** Doors will be constructed with a horizontal center rail and equally sized panels over 48" high.

# ELAN WALL CORNER CABINETS

## DIAGONAL CORNER WALL CABINET

- Specify Hinge (L or R)
- Decrease Depth not Available
- 24" Wide Cabinets are 12" Deep
- 27" Wide Cabinets are 15" Deep

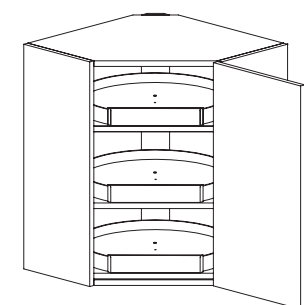
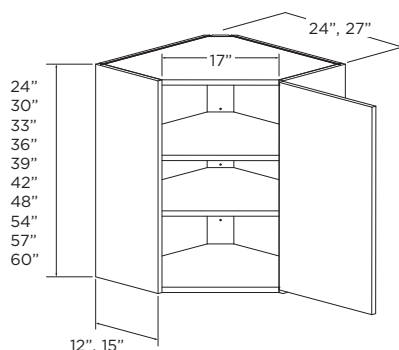

24" Wide Cabinet  
20" Diameter Wood Lazy Susan Trays

27" Wide Cabinet  
23" Diameter Wood Lazy Susan Trays

24" HIGH	A	B	C	D	E	F	G
1 Adjustable Shelf, 1 Adjustable Lazy Susan Tray, 1 Fixed Lazy Susan Tray							
EDCW2424	817	857	899	940	1005	1046	1095
EDCW272415	1226	1287	1350	1411	1509	1570	1644
EDCWLS2424	1112	1169	1224	1280	1369	1424	1491
EDCWLS272415	1614	1694	1775	1856	1985	2066	2163

30" HIGH	A	B	C	D	E	F	G
2 Adjustable Shelves, 2 Adjustable Lazy Susan Trays, 1 Fixed Lazy Susan Tray							
EDCW2430	896	941	987	1031	1103	1148	1202
EDCW273015	1302	1367	1433	1498	1601	1667	1746
EDCWLS2430	1251	1313	1377	1439	1539	1601	1676
EDCWLS273015	1689	1774	1859	1944	2078	2163	2264

33" HIGH	A	B	C	D	E	F	G
2 Adjustable Shelves, 2 Adjustable Lazy Susan Trays, 1 Fixed Lazy Susan Tray							
EDCW2433	956	1003	1052	1099	1176	1224	1281
EDCW273315	1388	1457	1527	1597	1708	1778	1861
EDCWLS2433	1277	1339	1405	1468	1570	1634	1710
EDCWLS273315	1717	1802	1889	1975	2112	2199	2302

36" HIGH	A	B	C	D	E	F	G
2 Adjustable Shelves, 2 Adjustable Lazy Susan Trays, 1 Fixed Lazy Susan Tray							
EDCW2436	1045	1098	1150	1203	1286	1339	1401
EDCW273615	1463	1537	1610	1683	1801	1874	1961
EDCWLS2436	1300	1364	1430	1495	1599	1664	1742
EDCWLS273615	1743	1830	1918	2005	2144	2232	2336

39" HIGH	A	B	C	D	E	F	G
3 Adjustable Shelves, 3 Adjustable Lazy Susan Trays, 1 Fixed Lazy Susan Tray							
EDCW2439	1114	1170	1226	1281	1370	1427	1493
EDCW273915	1539	1616	1693	1770	1894	1971	2064
EDCWLS2439	1383	1452	1522	1590	1702	1770	1853
EDCWLS273915	1835	1927	2020	2111	2258	2350	2460

42" HIGH	A	B	C	D	E	F	G
3 Adjustable Shelves, 3 Adjustable Lazy Susan Trays, 1 Fixed Lazy Susan Tray							
EDCW2442	1182	1241	1301	1361	1455	1513	1584
EDCW274215	1614	1694	1775	1856	1985	2066	2163
EDCWLS2442	1468	1542	1616	1689	1807	1880	1968
EDCWLS274215	1927	2023	2120	2216	2370	2467	2582

48" HIGH	A	B	C	D	E	F	G
3 Adjustable Shelves, 3 Adjustable Lazy Susan Trays, 1 Fixed Lazy Susan Tray							
EDCW2448	1299	1363	1429	1495	1598	1662	1740
EDCW274815	1773	1860	1949	2039	2180	2269	2375
EDCWLS2448	1649	1732	1815	1898	2030	2113	2211
EDCWLS274815	2306	2421	2537	2653	2837	2953	3091

54" HIGH	A	B	C	D	E	F	G
4 Adjustable Shelves, 4 Adjustable Lazy Susan Trays, 1 Fixed Lazy Susan Tray							
EDCW2454	1436	1506	1580	1652	1767	1838	1923
EDCW275415	1956	2052	2151	2249	2405	2504	2621
EDCWLS2454	1852	1945	2038	2131	2279	2372	2483
EDCWLS275415	2589	2719	2849	2980	3186	3317	3472

57" HIGH	A	B	C	D	E	F	G
4 Adjustable Shelves, 4 Adjustable Lazy Susan Trays, 1 Fixed Lazy Susan Tray							
EDCW2457	1531	1606	1684	1761	1883	1959	2050
EDCW275715	2086	2188	2293	2398	2564	2669	2794
EDCWLS2457	1967	2065	2164	2263	2420	2520	2637
EDCWLS275715	2750	2887	3026	3164	3384	3522	3687

60" HIGH	A	B	C	D	E	F	G
4 Adjustable Shelves, 4 Adjustable Lazy Susan Trays, 1 Fixed Lazy Susan Tray							
EDCW2460	1632	1712	1795	1878	2008	2088	2186
EDCW276015	2223	2332	2444	2556	2733	2845	2978
EDCWLS2460	2089	2193	2299	2404	2571	2676	2801
EDCWLS276015	2920	3066	3213	3361	3594	3741	3916

**DESIGN NOTES:** Doors will be constructed with a horizontal center rail and equally sized panels over 48" high.

# ELAN WALL CORNER CABINETS

## DIAGONAL CORNER SPLIT WALL

- Specify Hinge (L or R)
- Decrease Depth Not Available
- To change the top opening, specify Custom Frame Arrangement and the height of the opening.
- 24" wide cabinets are 12" deep
- 27" wide cabinets are 15" deep

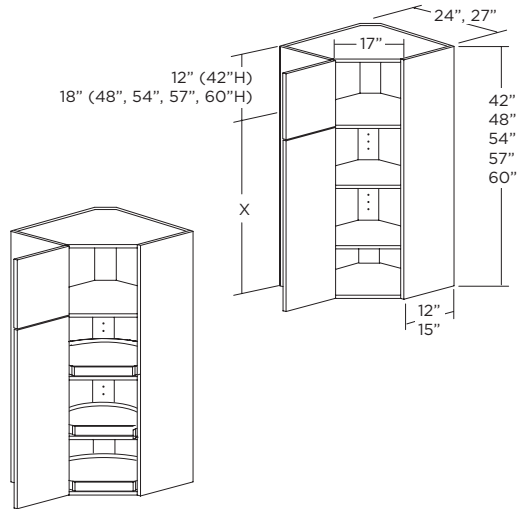

24" Wide Cabinet  
20" Diameter Wood Lazy Susan Trays

27" Wide Cabinet  
23" Diameter Wood Lazy Susan Trays

**DESIGN NOTE:** Height modifications affect the upper section only, unless otherwise specified.

## DIAGONAL CORNER WALL WITH TAMBOUR DOOR

- Specify Hinge (L or R)
- Tambour is available in standard species only. For Foil, Tambour will be Birch Natural unless a wood/finish is specified.
- Decrease Depth Not Available
- Tambour Clearance Height: 16-1/4"
- 24" wide cabinets are 12" deep
- 27" wide cabinets are 15" deep

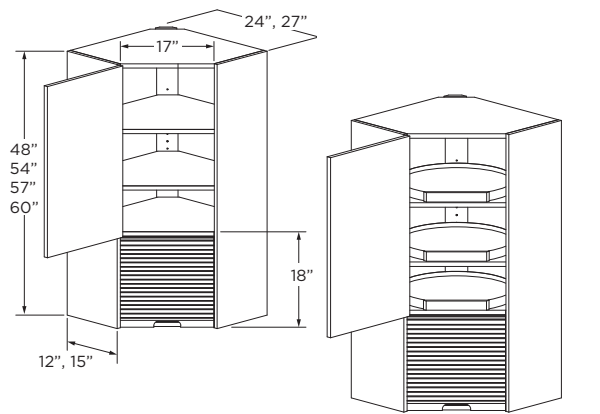

24" Wide Cabinet  
20" Diameter Wood Lazy Susan Trays

27" Wide Cabinet  
23" Diameter Wood Lazy Susan Trays

**DESIGN NOTE:** Height modifications affect the lower section only, unless otherwise specified.

42" HIGH	A	B	C	D	E	F	G
2 Adjustable Shelves, 2 Adjustable Lazy Susan Trays, 1 Fixed Lazy Susan Tray							
EDCSW2442	1769	1857	1946	2035	2176	2265	2370
EDCSW274215	2186	2295	2405	2515	2690	2798	2929
EDCSWLS2442	2421	2542	2663	2784	2978	3099	3245
EDCSWLS274215	2836	2978	3120	3262	3489	3631	3801

48" HIGH	A	B	C	D	E	F	G
2 Adjustable Shelves, 2 Adjustable Lazy Susan Trays, 1 Fixed Lazy Susan Tray							
EDCSW2448	2029	2128	2230	2332	2494	2596	2718
EDCSW274815	2505	2630	2757	2883	3083	3206	3359
EDCSWLS2448	2774	2913	3053	3193	3414	3551	3720
EDCSWLS274815	3252	3414	3578	3742	4001	4165	4360

54" HIGH	A	B	C	D	E	F	G
2 Adjustable Shelves, 2 Adjustable Lazy Susan Trays, 1 Fixed Lazy Susan Tray							
EDCSW2454	2325	2439	2556	2673	2858	2975	3114
EDCSW275415	2871	3014	3159	3304	3533	3675	3849
EDCSWLS2454	3179	3338	3499	3659	3913	4070	4263
EDCSWLS275415	3726	3913	4100	4288	4586	4773	4996

57" HIGH	A	B	C	D	E	F	G
3 Adjustable Shelves, 3 Adjustable Lazy Susan Trays, 1 Fixed Lazy Susan Tray							
EDCSW2457	2495	2617	2742	2868	3067	3193	3342
EDCSW275715	3080	3234	3390	3545	3791	3943	4130
EDCSWLS2457	3412	3582	3754	3926	4198	4367	4574
EDCSWLS275715	3998	4198	4400	4601	4920	5122	5361

60" HIGH	A	B	C	D	E	F	G
3 Adjustable Shelves, 3 Adjustable Lazy Susan Trays, 1 Fixed Lazy Susan Tray							
EDCSW2460	2677	2808	2943	3077	3291	3426	3586
EDCSW276015	3305	3471	3637	3804	4067	4231	4432
EDCSWLS2460	3661	3844	4028	4213	4505	4685	4908
EDCSWLS276015	4290	4505	4721	4937	5280	5496	5753

48" HIGH	A	B	C	D	E	F	G
2 Adjustable Shelves, 2 Adjustable Lazy Susan Trays, 1 Fixed Lazy Susan Tray							
EDCWT2448	1735	1822	1908	1995	2134	2221	2325
EDCWT274815	2170	2279	2388	2496	2670	2778	2908
EDCWTL2448	2037	2138	2241	2342	2506	2608	2730
EDCWTL274815	2491	2616	2741	2866	3065	3190	3339

54" HIGH	A	B	C	D	E	F	G
2 Adjustable Shelves, 2 Adjustable Lazy Susan Trays, 1 Fixed Lazy Susan Tray							
EDCWT2454	1983	2082	2182	2281	2440	2539	2658
EDCWT275415	2414	2535	2656	2778	2971	3090	3236
EDCWTL2454	2262	2375	2488	2601	2782	2895	3031
EDCWTL275415	2693	2828	2963	3098	3313	3447	3610

57" HIGH	A	B	C	D	E	F	G
3 Adjustable Shelves, 3 Adjustable Lazy Susan Trays, 1 Fixed Lazy Susan Tray							
EDCWT2457	2092	2197	2302	2406	2573	2678	2803
EDCWT275715	2524	2650	2778	2903	3105	3232	3384
EDCWTL2457	2386	2506	2626	2745	2935	3055	3198
EDCWT275715	2524	2650	2778	2903	3105	3232	3384

60" HIGH	A	B	C	D	E	F	G
3 Adjustable Shelves, 3 Adjustable Lazy Susan Trays, 1 Fixed Lazy Susan Tray							
EDCWT2460	2201	2311	2421	2531	2707	2817	2949
EDCWT276015	2633	2765	2897	3029	3240	3372	3529
EDCWTL2460	2512	2638	2764	2890	3090	3216	3367
EDCWTL276015	2944	3090	3238	3386	3621	3769	3945

# ELAN WALL CORNER CABINETS

## DIAGONAL CORNER WALL WITH APPLIANCE GARAGE

- Specify Hinge (L or R)
- Decrease Depth not Available
- Lower section clearance height 17-13/16"
- 24" wide cabinets are 12" deep
- 27" wide cabinets are 15" deep

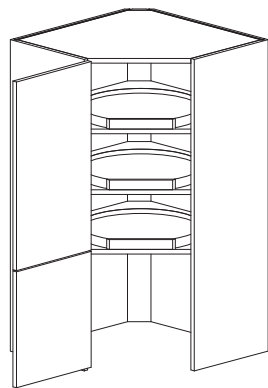
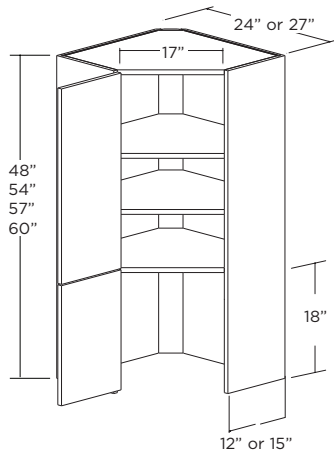

24"W Cabinet 20" Diameter  
Lazy Susan Trays.

27"W Cabinet 23" Diameter  
Lazy Susan Trays.

48" HIGH	A	B	C	D	E	F	G
2 Adjustable Shelves							
EDCWG2448	1520	1595	1672	1748	1869	1946	2037
EDCWG274815	1963	2061	2160	2258	2416	2513	2632
3 Lazy Susans Trays, 2 Adjustable Shelves							
EDCWGLS2448	1770	1858	1947	2037	2178	2267	2373
EDCWGLS274815	2213	2324	2434	2545	2723	2833	2966
54" HIGH	A	B	C	D	E	F	G
2 Adjustable Shelves							
EDCWG2454	1742	1829	1917	2004	2143	2230	2335
EDCWG275415	2188	2297	2407	2517	2692	2802	2933
3 Lazy Susans Trays, 2 Adjustable Shelves							
EDCWGLS2454	2020	2121	2223	2323	2484	2586	2707
EDCWGLS275415	2465	2588	2712	2835	3032	3155	3303
57" HIGH	A	B	C	D	E	F	G
3 Adjustable Shelves							
EDCWG2457	1852	1945	2038	2131	2279	2372	2483
EDCWG275715	2296	2411	2526	2641	2824	2939	3077
4 Lazy Susans Trays, 3 Adjustable Shelves							
EDCWGLS2457	2145	2253	2361	2468	2639	2747	2875
EDCWGLS275715	2590	2720	2850	2979	3187	3317	3472
60" HIGH	A	B	C	D	E	F	G
3 Adjustable Shelves							
EDCWG2460	1961	2059	2158	2256	2412	2511	2628
EDCWG276015	2405	2524	2645	2767	2958	3078	3223
4 Lazy Susans Trays, 3 Adjustable Shelves							
EDCWGLS2460	2269	2383	2496	2610	2791	2905	3042
EDCWGLS276015	2714	2850	2985	3121	3339	3474	3637

# ELAN WALL CORNER CABINETS

## DIAGONAL CORNER WALL WITH LIFT UP APPLIANCE GARAGE

- Specify Hinge (L or R)
- Decrease Depth not Available
- Interior clearance height 17"
- Usable interior width is opening width less 3"
- Aventos HL Hardware

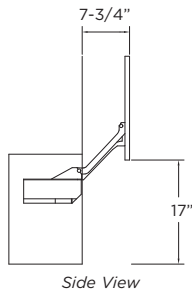
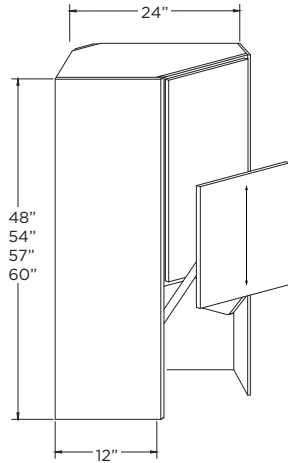

48" HIGH	A	B	C	D	E	F	G
2 Adjustable Shelves, 2 Adjustable Lazy Susan Trays, 1 Fixed Lazy Susan Tray							
EDCWGLUA2448	2170	2245	2322	2398	2519	2596	2687
EDCWGLSLUA2448	2613	2711	2810	2908	3066	3063	3282
EDCWGLUA274815	2420	2508	2597	2687	2828	2917	3023
EDCWGLSLUA274815	2863	2974	3084	3195	3373	3483	3616

54" HIGH	A	B	C	D	E	F	G
2 Adjustable Shelves, 2 Adjustable Lazy Susan Trays, 1 Fixed Lazy Susan Tray							
EDCWGLUA2454	2392	2479	2567	2654	2793	2880	2985
EDCWGLSLUA2454	2838	2947	3057	3167	3342	3452	3583
EDCWGLUA275415	2670	2771	2873	2973	3134	3236	3357
EDCWGLSLUA275415	3115	3238	3362	3485	3682	3805	3953

57" HIGH	A	B	C	D	E	F	G
3 Adjustable Shelves, 3 Adjustable Lazy Susan Trays, 1 Fixed Lazy Susan Tray							
EDCWGLUA2457	2502	2595	2688	2781	2929	3022	3133
EDCWGLSLUA2457	2946	3061	3176	3291	3474	3589	3727
EDCWGLUA275715	2795	2903	3011	3118	3289	3397	3525
EDCWGLSLUA275715	3240	3370	3500	3629	3837	3967	4122

60" HIGH	A	B	C	D	E	F	G
3 Adjustable Shelves, 3 Adjustable Lazy Susan Trays, 1 Fixed Lazy Susan Tray							
EDCWGLUA2460	2611	2709	2808	2906	3062	3161	3278
EDCWGLSLUA2460	3055	3174	3295	3417	3608	3728	3873
EDCWGLUA276015	2919	3033	3146	3260	3441	3555	3692
EDCWGLSLUA276015	3364	3500	3635	3771	3989	4124	4287

**DESIGN NOTE:** Height modifications affect the upper section only unless otherwise specified.

# ELAN WALL CORNER CABINETS

## PENINSULA BLIND CORNER WALL 24", 30" & 36" HIGH

- On Single Door Cabinets the Door is Hinged on the Blind Side.
- Specify Which Side is Blind Left (BL) or Right (BR)
- 15" blind panel. Blind cabinet does not need to be pulled from corner but can be if larger reveals are needed.

### SINGLE DOOR (KITCHEN SIDE)

### BUTT DOOR (PENINSULA SIDE)

- Door Hinged on Blind Side
- 24"W - 36"W

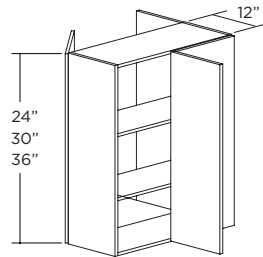

Peninsula Left Shown

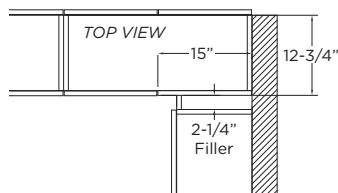

### BUTT DOORS (KITCHEN SIDE)

### DOUBLE DOORS (PENINSULA SIDE) 39"W - 48"W

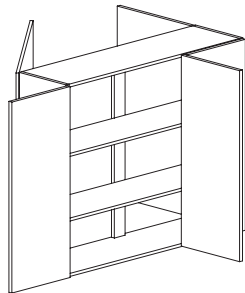

24" HIGH	A	B	C	D	E	F	G
1 Adjustable Shelf							
EPBCW2424	949	996	1044	1092	1167	1215	1271
EPBCW2724	1138	1196	1253	1309	1401	1457	1526
EPBCW3024	1249	1312	1375	1438	1538	1600	1675
EPBCW3324	1298	1363	1429	1494	1598	1663	1741
EPBCW3624	1350	1417	1485	1553	1660	1729	1809
EPBCW3924	1402	1472	1543	1614	1725	1796	1879
EPBCW4224	1450	1522	1595	1667	1784	1857	1944
EPBCW4524	1504	1579	1654	1730	1850	1925	2016
EPBCW4824	1561	1639	1718	1796	1921	1999	2093

30" HIGH	A	B	C	D	E	F	G
2 Adjustable Shelves							
EPBCW2430	1090	1145	1200	1254	1342	1396	1462
EPBCW2730	1279	1342	1407	1471	1573	1637	1714
EPBCW3030	1413	1484	1555	1626	1738	1809	1895
EPBCW3330	1461	1534	1608	1681	1797	1870	1958
EPBCW3630	1509	1584	1660	1736	1856	1932	2022
EPBCW3930	1556	1634	1713	1790	1914	1993	2086
EPBCW4230	1604	1685	1765	1845	1973	2054	2150
EPBCW4530	1645	1727	1811	1892	2024	2106	2205
EPBCW4830	1685	1769	1853	1938	2072	2156	2258

36" HIGH	A	B	C	D	E	F	G
2 Adjustable Shelves							
EPBCW2436	1189	1249	1309	1368	1463	1523	1594
EPBCW2736	1395	1465	1535	1605	1716	1786	1869
EPBCW3036	1533	1610	1687	1764	1886	1963	2055
EPBCW3336	1586	1665	1745	1824	1951	2031	2125
EPBCW3636	1645	1727	1811	1892	2024	2106	2205
EPBCW3936	1697	1781	1867	1952	2088	2172	2274
EPBCW4236	1756	1844	1932	2020	2160	2248	2353
EPBCW4536	1808	1899	1989	2079	2225	2315	2423
EPBCW4836	1863	1956	2050	2143	2292	2385	2498

CABINET WIDTH	DOOR SECTION WIDTH	BLIND WIDTH
24"	9"	15"
27"	12"	15"
30"	15"	15"
33"	18"	15"
36"	21"	15"
39"	24"	15"
42"	27"	15"
45"	30"	15"
48"	33"	15"

**DESIGN NOTE:** When changing width the door section changes.

# ELAN WALL CORNER CABINETS

## PENINSULA BLIND CORNER WALL 39", 42" & 48" HIGH

- On Single Door Cabinets the Door is Hinged on the Blind Side.
- Specify Which Side is Blind Left (BL) or Right (BR)
- 15" blind panel. Cabinet does not need to be pulled from the corner but can be for additional clearance if needed.

### SINGLE DOOR (KITCHEN SIDE)

### BUTT DOOR (PENINSULA SIDE)

- Door Hinged on Blind Side
- 24"W - 36"W

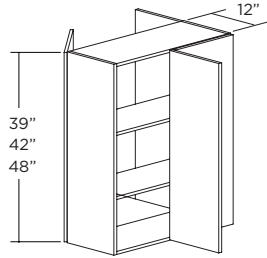

Peninsula Left Shown

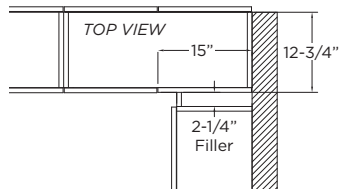

### BUTT DOORS (KITCHEN SIDE)

### DOUBLE DOORS (PENINSULA SIDE) 39"W - 48"W

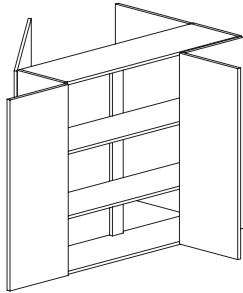

39" HIGH	A	B	C	D	E	F	G
3 Adjustable Shelves							
EPBCW2439	1229	1290	1352	1413	1512	1573	1647
EPBCW2739	1444	1516	1589	1661	1776	1848	1935
EPBCW3039	1612	1693	1774	1855	1984	2065	2161
EPBCW3339	1666	1749	1834	1917	2050	2133	2234
EPBCW3639	1720	1806	1892	1979	2116	2202	2306
EPBCW3939	1775	1864	1954	2042	2183	2273	2379
EPBCW4239	1831	1923	2015	2106	2253	2345	2455
EPBCW4539	1889	1983	2078	2172	2324	2418	2532
EPBCW4839	1946	2044	2142	2238	2395	2491	2609

42" HIGH	A	B	C	D	E	F	G
3 Adjustable Shelves							
EPBCW2442	1268	1331	1395	1458	1560	1623	1699
EPBCW2742	1491	1566	1641	1715	1835	1910	1999
EPBCW3042	1696	1780	1866	1951	2087	2171	2273
EPBCW3342	1748	1836	1923	2011	2150	2238	2344
EPBCW3642	1801	1891	1982	2071	2215	2306	2413
EPBCW3942	1855	1947	2040	2133	2281	2374	2485
EPBCW4242	1906	2001	2097	2192	2345	2440	2555
EPBCW4542	1968	2067	2165	2264	2422	2520	2638
EPBCW4842	2031	2132	2235	2336	2499	2600	2721

48" HIGH	A	B	C	D	E	F	G
3 Adjustable Shelves							
EPBCW2448	1349	1416	1484	1552	1660	1728	1808
EPBCW2748	1586	1667	1747	1825	1954	2034	2127
EPBCW3048	1803	1894	1986	2077	2221	2310	2418
EPBCW3348	1861	1954	2046	2140	2288	2382	2495
EPBCW3648	1917	2013	2109	2204	2357	2454	2568
EPBCW3948	1974	2071	2171	2270	2427	2527	2645
EPBCW4248	2028	2129	2231	2334	2495	2598	2719
EPBCW4548	2095	2199	2305	2411	2578	2681	2806
EPBCW4848	2162	2270	2379	2485	2660	2767	2896

CABINET WIDTH	DOOR SECTION WIDTH	BLIND WIDTH
24"	9"	15"
27"	12"	15"
30"	15"	15"
33"	18"	15"
36"	21"	15"
39"	24"	15"
42"	27"	15"
45"	30"	15"
48"	33"	15"

# ELAN WALL CORNER CABINETS

## PENINSULA SQUARE CORNER WALL CABINET

- Specify Hinge (L or R) For Kitchen Side
- Specify Peninsula (PL or PR) Left Shown
- Decrease Depth not Available
- Decorative Mullion Doors not Available on Kitchen Side

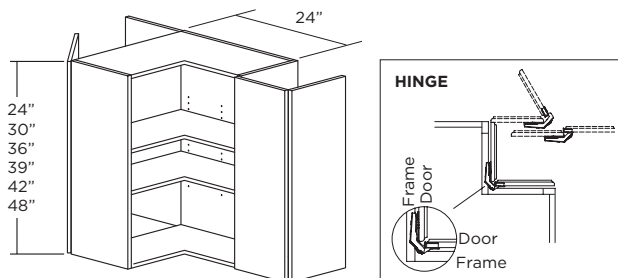

Peninsula Left Shown

ITEM	A	B	C	D	E	F	G
<b>24" HIGH</b>	1 Adjustable Shelf						
EPSCW2424	1205	1265	1326	1386	1483	1544	1616
<b>30" HIGH</b>	2 Adjustable Shelves						
EPSCW2430	1385	1455	1524	1593	1704	1774	1857
<b>36" HIGH</b>	2 Adjustable Shelves						
EPSCW2436	1566	1644	1724	1802	1927	2005	2099
<b>39" HIGH</b>	3 Adjustable Shelves						
EPSCW2439	1672	1756	1840	1924	2057	2142	2242
<b>42" HIGH</b>	3 Adjustable Shelves						
EPSCW2442	1778	1867	1956	2045	2187	2276	2383
<b>48" HIGH</b>	3 Adjustable Shelves						
EPSCW2448	2009	2110	2211	2312	2473	2572	2694

## PENINSULA DIAGONAL CORNER WALL

- Specify Hinge (L or R)
- Specify Peninsula (PL or PR) Right Shown
- Decrease Depth not Available

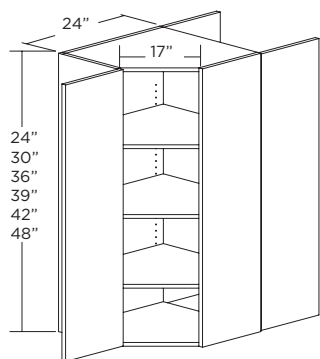

Peninsula Right Shown

ITEM	A	B	C	D	E	F	G
<b>24" HIGH</b>	1 Adjustable Shelf						
EPDCW2424	1270	1334	1397	1461	1562	1626	1703
<b>30" HIGH</b>	2 Adjustable Shelves						
EPDCW2430	1359	1428	1496	1564	1672	1741	1823
<b>36" HIGH</b>	2 Adjustable Shelves						
EPDCW2436	1537	1614	1691	1768	1891	1967	2060
<b>39" HIGH</b>	3 Adjustable Shelves						
EPDCW2439	1648	1730	1813	1896	2028	2110	2209
<b>42" HIGH</b>	3 Adjustable Shelves						
EPDCW2442	1757	1845	1933	2021	2161	2249	2355
<b>48" HIGH</b>	3 Adjustable Shelves						
EPDCW2448	1986	2085	2185	2285	2443	2541	2662

## PENINSULA DIAGONAL CORNER SPLIT WALL

- Specify Hinge (L or R)
- Specify Peninsula (PL or PR) Right Shown

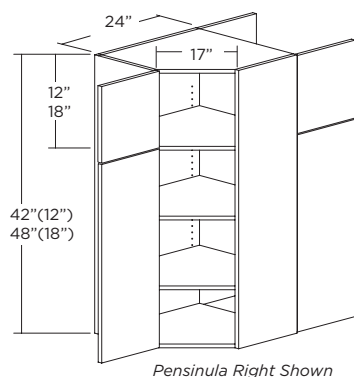

Peninsula Right Shown

42" HIGH	A	B	C	D	E	F	G
2 Adjustable Shelves							
EPDCSW2442	2543	2670	2797	2924	3128	3256	3408
48" HIGH	A	B	C	D	E	F	G
2 Adjustable Shelves							
EPDCSW2448	2873	3017	3162	3304	3536	3681	3853

**DESIGN NOTE:** Height modifications affect the lower section only, unless otherwise specified.





**TABLE OF CONTENTS**

**ELAN WALL SPECIALTY CABINETS .....E300-1 THRU E300-14**

Wall Single Door Lift Up ..... E300-2 thru E300-3  
Wall Bi-Fold Lift Up ..... E300-4  
Appliance Garages ..... E300-5  
Wall Angle Corner/Corner Angle..... E300-6  
Wall End Shelf/Wine Storage Cabinets..... E300-7  
Wall Organizer Cabinets..... E300-8 thru E300-9  
Wall Organizer Full Height Doors..... E300-10 thru E300-11  
Wall Microwave Cabinets..... E300-12 thru E300-13  
Pull-Out Spice Rack..... E300-13  
Wall Pull-Out Filler ..... E300-13  
Wall Spice Rack/Spice Rack Door..... E300-14  
Wall Condiment Drawers..... E300-14  
Desk Organizer ..... E300-14  
Wood Floating Shelf..... E300-14  
Soffit Panel ..... E300-14  
Stemware Holder..... E300-14



# ELAN WALL SPECIALTY CABINETS

## WALL SINGLE DOOR LIFT UP - STYLE A

- Specify Vertical or Horizontal Grain (V or H)
- Decrease Depth not Available
- Aventos HL Hardware

### 18"W - 24"W (V)

- Vertical Grain
- Single Panel

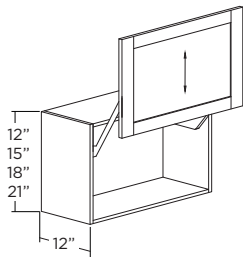

### 27"W - 42"W (V)

- Vertical Grain
- Two Panel

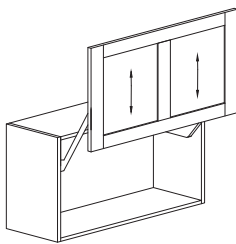

### 18"W - 42"W (H)

- Horizontal Grain
- Single Panel

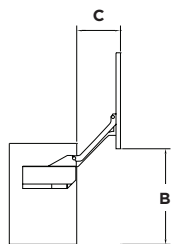
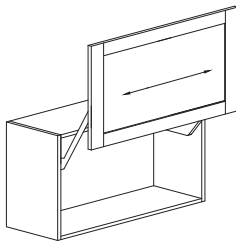

Side View

**A:** Distance Needed from the Top of the Cabinet to the Ceiling for Proper Door Function

CABINET	A	B	C
12" High	10-1/2"	10-7/8"	4-1/2"
15" High	13-7/8"	13-5/8"	5-3/4"
18" High	17-3/8"	17"	7"
21" High	20-5/8"	20-1/4"	8-3/8"

12" HIGH	A	B	C	D	E	F	G
EWSDLUA1812	1098	1152	1209	1264	1352	1406	1473
EWSDLUA2112	1114	1170	1227	1282	1371	1427	1492
EWSDLUA2412	1134	1191	1248	1305	1397	1451	1520
EWSDLUA2712	1201	1260	1321	1382	1478	1537	1610
EWSDLUA3012	1221	1282	1345	1405	1503	1564	1636
EWSDLUA3312	1251	1312	1376	1439	1539	1600	1677
EWSDLUA3612	1263	1326	1389	1452	1554	1618	1692
EWSDLUA3912	1293	1357	1423	1488	1591	1655	1734
EWSDLUA4212	1306	1372	1436	1502	1608	1673	1750

15" HIGH	A	B	C	D	E	F	G
EWSDLUA1815	1170	1227	1287	1346	1439	1497	1568
EWSDLUA2115	1186	1246	1307	1365	1460	1520	1589
EWSDLUA2415	1208	1268	1329	1390	1487	1546	1619
EWSDLUA2715	1279	1342	1407	1471	1573	1637	1714
EWSDLUA3015	1301	1366	1432	1496	1600	1665	1743
EWSDLUA3315	1331	1397	1465	1532	1638	1704	1785
EWSDLUA3615	1345	1412	1479	1546	1654	1721	1802
EWSDLUA3915	1377	1444	1515	1585	1694	1762	1846
EWSDLUA4215	1391	1460	1529	1599	1712	1782	1863

18" HIGH	A	B	C	D	E	F	G
EWSDLUA1818	1236	1298	1360	1421	1520	1582	1657
EWSDLUA2118	1254	1317	1380	1444	1544	1606	1683
EWSDLUA2418	1285	1350	1414	1478	1581	1645	1723
EWSDLUA2718	1318	1384	1450	1516	1621	1687	1767
EWSDLUA3018	1346	1413	1482	1549	1656	1724	1804
EWSDLUA3318	1374	1443	1512	1581	1691	1759	1842
EWSDLUA3618	1396	1466	1537	1606	1718	1787	1872
EWSDLUA3918	1426	1498	1569	1641	1754	1825	1912
EWSDLUA4218	1448	1521	1595	1667	1782	1854	1942

21" HIGH	A	B	C	D	E	F	G
1 Adjustable Shelf							
EWSDLUA1821	1261	1323	1386	1451	1550	1614	1689
EWSDLUA2121	1296	1360	1427	1492	1595	1659	1738
EWSDLUA2421	1317	1383	1449	1515	1620	1686	1765
EWSDLUA2721	1355	1422	1490	1559	1666	1735	1815
EWSDLUA3021	1378	1446	1516	1586	1696	1764	1847
EWSDLUA3321	1412	1483	1554	1625	1737	1808	1892
EWSDLUA3621	1435	1507	1579	1652	1767	1837	1924
EWSDLUA3921	1471	1546	1620	1695	1811	1885	1973
EWSDLUA4221	1496	1571	1646	1722	1843	1915	2006

# ELAN WALL SPECIALTY CABINETS

## WALL SINGLE DOOR LIFT UP - STYLE B

- Specify Vertical or Horizontal Grain (V or H)
- Minimum Depth 9-3/4"
- Aventos HK Hardware

### 18"W - 24"W (V)

- Vertical Grain
- Single Panel

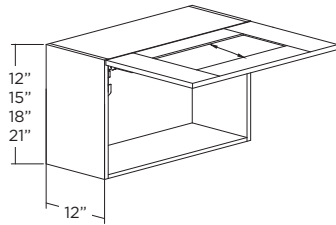

### 27"W - 42"W (V)

- Vertical Grain
- Two Panel

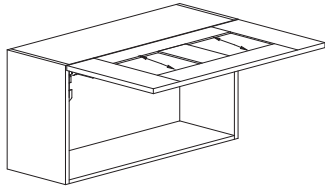

### 18"W - 42"W (H)

- Horizontal Grain
- Single Panel

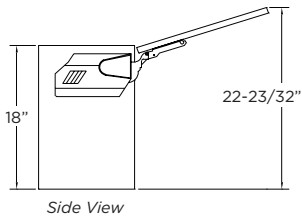
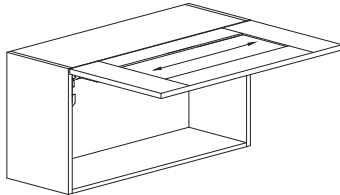

Distance Needed from the Top of the Cabinet to the Ceiling for Proper Door Function

CABINET	HEIGHT
12" High	3-3/8"
15" High	4-1/4"
18" High	5-1/4"
21" High	6"

12" HIGH	A	B	C	D	E	F	G
EWSDLUB1812	833	876	918	959	1026	1067	1117
EWSDLUB2112	895	940	986	1031	1101	1145	1200
EWSDLUB2412	913	958	1004	1050	1124	1170	1226
EWSDLUB2712	978	1028	1078	1126	1205	1253	1312
EWSDLUB3012	999	1049	1100	1151	1229	1279	1339
EWSDLUB3312	1028	1079	1131	1183	1264	1316	1378
EWSDLUB3612	1040	1092	1145	1197	1280	1332	1395
EWSDLUB3912	1070	1124	1178	1232	1316	1370	1435
EWSDLUB4212	1083	1137	1192	1247	1333	1388	1452

15" HIGH	A	B	C	D	E	F	G
EWSDLUB1815	954	1001	1050	1098	1174	1221	1279
EWSDLUB2115	967	1016	1065	1113	1190	1239	1296
EWSDLUB2415	985	1034	1084	1133	1213	1262	1322
EWSDLUB2715	1056	1109	1163	1215	1300	1352	1416
EWSDLUB3015	1078	1132	1187	1241	1326	1380	1445
EWSDLUB3315	1109	1164	1220	1276	1364	1419	1487
EWSDLUB3615	1122	1178	1235	1291	1381	1438	1505
EWSDLUB3915	1154	1212	1270	1329	1419	1478	1548
EWSDLUB4215	1168	1227	1286	1344	1438	1497	1567

18" HIGH	A	B	C	D	E	F	G
EWSDLUB1818	1004	1055	1106	1155	1236	1286	1346
EWSDLUB2118	1036	1088	1140	1191	1275	1326	1388
EWSDLUB2418	1064	1116	1170	1224	1309	1362	1425
EWSDLUB2718	1095	1150	1205	1260	1348	1402	1468
EWSDLUB3018	1123	1180	1236	1292	1383	1439	1506
EWSDLUB3318	1152	1209	1268	1325	1417	1474	1544
EWSDLUB3618	1174	1232	1291	1350	1444	1502	1573
EWSDLUB3918	1201	1262	1322	1383	1477	1538	1611
EWSDLUB4218	1224	1286	1347	1409	1507	1568	1642

21" HIGH	A	B	C	D	E	F	G
1 Adjustable Shelf							
EWSDLUB1821	1038	1088	1142	1193	1276	1329	1390
EWSDLUB2121	1072	1125	1179	1233	1319	1372	1437
EWSDLUB2421	1094	1149	1204	1259	1346	1401	1467
EWSDLUB2721	1132	1188	1246	1302	1392	1450	1517
EWSDLUB3021	1155	1213	1271	1329	1422	1479	1549
EWSDLUB3321	1189	1249	1309	1368	1463	1523	1594
EWSDLUB3621	1213	1274	1335	1395	1493	1553	1626
EWSDLUB3921	1249	1312	1375	1437	1537	1600	1674
EWSDLUB4221	1274	1338	1403	1466	1569	1632	1708

# ELAN WALL SPECIALTY CABINETS

## WALL BI-FOLD LIFT UP

- Specify Vertical or Horizontal Grain (V or H)
- Decrease Depth not Available.
- Min. Height: 18-7/8", Max. Height: 42"
- Min. Width: 12", Max. Width: 72"
- Aventos HF Hardware

### 18"W - 24"W (V)

- Vertical Grain

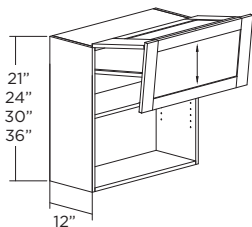

### 27"W - 42"W (V)

- Vertical Grain
- Two Panel

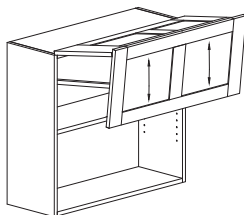

### 18"W - 42"W (V)

- Horizontal Grain
- Single Panel

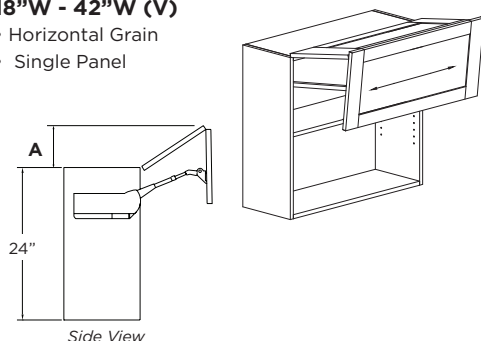

A: Door extends above cabinet approximately:

CABINET	A
21"	6"
24"	6-3/4"
30"	8"
36"	9-3/8"

21" HIGH	A	B	C	D	E	F	G
1 Adjustable Shelf							
EWBFLU1821	1183	1243	1302	1362	1456	1516	1587
EWBFLU2121	1225	1286	1348	1408	1506	1568	1641
EWBFLU2421	1268	1331	1395	1458	1560	1623	1699
EWBFLU2721	1311	1377	1443	1507	1612	1678	1757
EWBFLU3021	1336	1403	1471	1537	1644	1712	1791
EWBFLU3321	1377	1445	1515	1583	1693	1763	1845
EWBFLU3621	1403	1473	1544	1615	1727	1797	1881
EWBFLU3921	1452	1525	1598	1669	1785	1858	1945
EWBFLU4221	1503	1578	1654	1728	1848	1923	2013

24" HIGH	A	B	C	D	E	F	G
1 Adjustable Shelf							
EWBFLU1824	1215	1276	1337	1398	1495	1556	1629
EWBFLU2124	1256	1319	1382	1444	1545	1608	1683
EWBFLU2424	1300	1364	1430	1495	1599	1664	1742
EWBFLU2724	1342	1410	1477	1544	1652	1719	1800
EWBFLU3024	1370	1439	1509	1577	1686	1754	1837
EWBFLU3324	1412	1483	1554	1625	1737	1808	1892
EWBFLU3624	1441	1513	1586	1658	1774	1846	1932
EWBFLU3924	1490	1564	1640	1713	1832	1907	1996
EWBFLU4224	1541	1618	1695	1771	1894	1972	2064

30" HIGH	A	B	C	D	E	F	G
2 Adjustable Shelves							
EWBFLU1830	1289	1353	1418	1483	1586	1651	1728
EWBFLU2130	1343	1410	1477	1544	1651	1719	1799
EWBFLU2430	1400	1469	1540	1610	1723	1792	1877
EWBFLU2730	1457	1531	1604	1676	1793	1866	1954
EWBFLU3030	1496	1571	1647	1721	1841	1916	2006
EWBFLU3330	1544	1621	1699	1776	1900	1977	2070
EWBFLU3630	1581	1660	1740	1818	1945	2024	2119
EWBFLU3930	1647	1730	1813	1894	2026	2109	2207
EWBFLU4230	1717	1802	1889	1974	2111	2197	2300

36" HIGH	A	B	C	D	E	F	G
2 Adjustable Shelves							
EWBFLU1836	1352	1419	1488	1556	1664	1732	1813
EWBFLU2136	1414	1485	1556	1626	1739	1810	1894
EWBFLU2436	1479	1553	1627	1702	1820	1894	1983
EWBFLU2736	1548	1625	1703	1780	1905	1982	2075
EWBFLU3036	1590	1670	1751	1830	1957	2037	2132
EWBFLU3336	1647	1729	1812	1895	2026	2109	2207
EWBFLU3636	1683	1768	1852	1936	2071	2155	2257
EWBFLU3936	1761	1849	1938	2025	2166	2254	2360
EWBFLU4236	1842	1934	2027	2118	2265	2358	2468

## WALL BI-FOLD LIFT UP WITH A METAL/GLASS DOOR

- If wanting drilled for hardware needs to be done at ordering with a drawing or will be sent at no drill.
- Metal Door is aluminum in a satin finish.
- White Frosted Opaque Glass is included.
- Decrease depth not available.
- Additional Lead Time Required
- Aventos HF Hardware

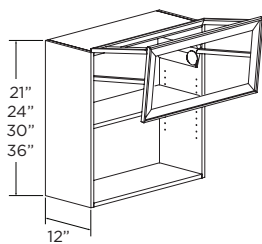

21" HIGH	PRICE	24" HIGH	PRICE	30" HIGH	PRICE	36" HIGH	PRICE
1 Adjustable Shelf		1 Adjustable Shelf		2 Adjustable Shelves		2 Adjustable Shelves	
EWBFLUM1821	2482	EWBFLUM1824	2412	EWBFLUM1830	2661	EWBFLUM1836	2902
EWBFLUM2121	2504	EWBFLUM2124	2477	EWBFLUM2130	2698	EWBFLUM2136	2934
EWBFLUM2421	2527	EWBFLUM2424	2544	EWBFLUM2430	2736	EWBFLUM2436	2966
EWBFLUM2721	2551	EWBFLUM2724	2612	EWBFLUM2730	2773	EWBFLUM2736	2998
EWBFLUM3021	2609	EWBFLUM3024	2636	EWBFLUM3030	2828	EWBFLUM3036	3110
EWBFLUM3321	2639	EWBFLUM3324	2737	EWBFLUM3330	2994	EWBFLUM3336	3172
EWBFLUM3621	2659	EWBFLUM3624	2760	EWBFLUM3630	3105	EWBFLUM3636	3243
EWBFLUM3921	2683	EWBFLUM3924	2835	EWBFLUM3930	3148	EWBFLUM3936	3279
EWBFLUM4221	2707	EWBFLUM4224	2911	EWBFLUM4230	3193	EWBFLUM4236	3315

# ELAN WALL SPECIALTY CABINETS

## APPLIANCE GARAGES - HINGED DOOR

- Specify Hinge (L or R)
- 24" Wide Cabinets are 12" Deep
- 27" Wide Cabinets are 15" Deep
- Clearance height 17-1/4"

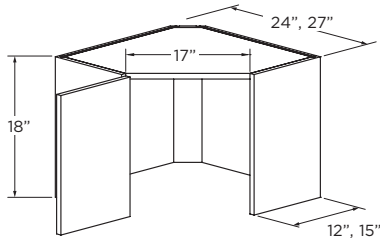

18" HIGH	A	B	C	D	E	F	G
EAG2418	598	627	658	688	736	765	802
EAG271815	705	741	776	812	868	903	946

## APPLIANCE GARAGES - LIFT UP DOOR

- Vertical Grain
- Aventos HL Hardware

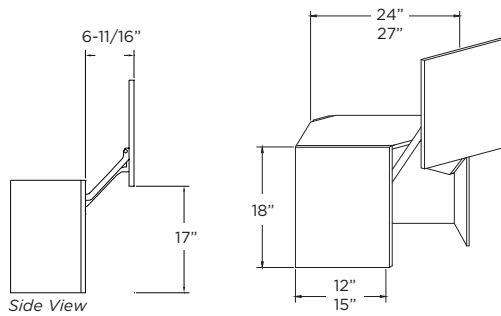

18" HIGH	A	B	C	D	E	F	G
EAGLUA2418	1248	1277	1308	1338	1386	1415	1452
EAGLUA271815	1355	1391	1426	1462	1518	1553	1596

## APPLIANCE GARAGES - TAMBOUR DOOR

- Tambour is available in standard species only. For Foil, Tambour will be Birch Natural unless a wood/finish is specified.
- Tambour clearance height 15-1/2"

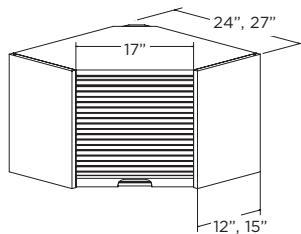

18" HIGH	PRICE
ETAG2418	994
ETAG271815	1175

## STRAIGHT WALL CABINETS - HINGED DOOR(S)

- Decrease Depth Not Available
- Clearance height 17-1/4"

### SINGLE DOOR

- Specify Hinge (L or R)
- 18"W - 24-1"W

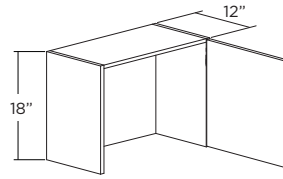

### BUTT DOORS

- 24-2"W - 36"W

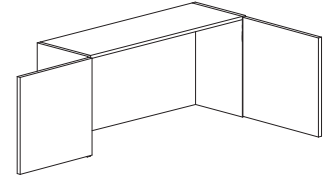

18" HIGH	A	B	C	D	E	F	G
EGWC15	444	467	490	512	549	571	599
EGWC18	466	490	513	538	576	599	628
EGWC21	495	521	546	571	611	637	667
EGWC24-1	523	550	577	604	646	673	705
EGWC24-2	639	672	705	737	790	821	860
EGWC27	672	706	741	775	830	864	904
EGWC30	700	737	772	808	864	900	942
EGWC33	728	766	803	840	898	936	980
EGWC36	750	790	827	865	926	964	1010

## LIFT UP DOOR - STYLE A

- Specify Vertical (V)
- Aventos HL Hardware
- 27-36" vertical has 2 panels
- Decrease depth not available

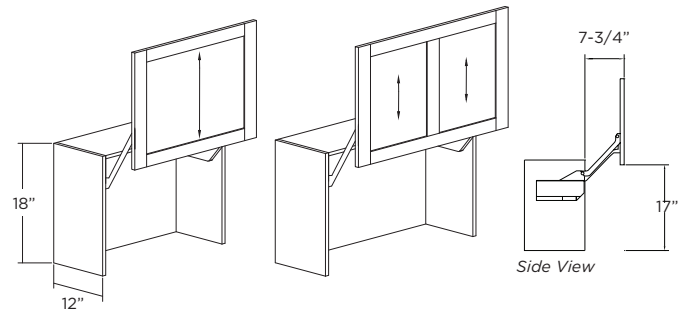

18" HIGH	A	B	C	D	E	F	G
EWCLUA15	1094	1117	1140	1162	1199	1221	1249
EWCLUA18	1116	1140	1163	1188	1226	1249	1278
EWCLUA21	1145	1171	1196	1221	1261	1287	1317
EWCLUA24	1173	1200	1227	1254	1296	1323	1377
EWCLUA27	1322	1356	1391	1425	1480	1514	1568
EWCLUA30	1350	1387	1422	1458	1514	1550	1604
EWCLUA33	1378	1416	1453	1490	1548	1586	1640
EWCLUA36	1400	1440	1477	1515	1576	1614	1670

## TAMBOUR DOOR

- Tambour is available in standard species only. For Foil, Tambour will be Birch Natural unless a wood/finish is specified.
- Tambour clearance height 15-1/2"

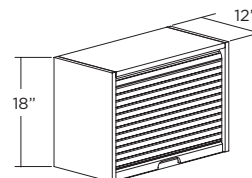

18" HIGH	PRICE
ETWC15	749
ETWC18	792
ETWC21	851
ETWC24	886
ETWC27	925
ETWC30	961
ETWC33	996
ETWC36	1035

# ELAN WALL SPECIALTY CABINETS

## WALL ANGLE CORNER

- Decrease Depth not Available
- Mullion Doors not Available

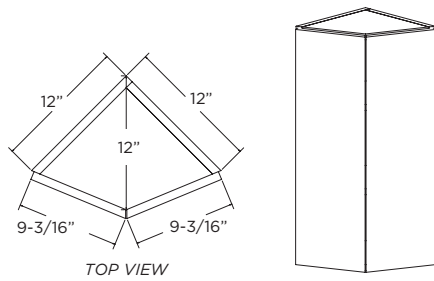

ITEM	A	B	C	D	E	F	G
2 Adjustable Shelves							
EWAC1230	688	722	757	792	847	881	922
EWAC1233	724	760	797	834	892	928	971
EWAC1236	760	798	836	874	935	973	1019
3 Adjustable Shelves							
EWAC1239	798	838	878	918	982	1022	1070
EWAC1242	835	877	919	961	1028	1069	1119
EWAC1248	874	918	962	1006	1076	1119	1172
4 Adjustable Shelves							
EWAC1254	918	964	1010	1057	1130	1176	1231
EWAC1257	961	1009	1058	1106	1183	1232	1289
EWAC1260	1007	1057	1108	1158	1239	1289	1350

## WALL CORNER ANGLE

- Specify Hinge L or R
- Decrease Depth not Available

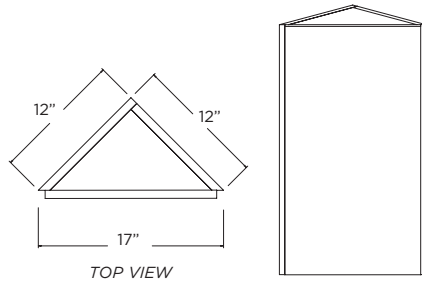

ITEM	A	B	C	D	E	F	G
2 Adjustable Shelves							
EWCA1230	811	852	893	933	998	1039	1087
EWCA1233	855	898	941	985	1053	1096	1147
EWCA1236	899	944	989	1034	1106	1151	1205
3 Adjustable Shelves							
EWCA1239	944	991	1039	1086	1162	1209	1265
EWCA1242	988	1037	1087	1137	1216	1265	1324
EWCA1248	1033	1085	1137	1189	1271	1322	1384
4 Adjustable Shelves							
EWCA1254	1085	1139	1194	1248	1335	1390	1454
EWCA1257	1135	1191	1249	1306	1396	1453	1521
EWCA1260	1187	1246	1306	1366	1460	1520	1591

# ELAN WALL SPECIALTY CABINETS

## WALL END SHELF

- Specify Shelves (L or R)
- 6" Radius

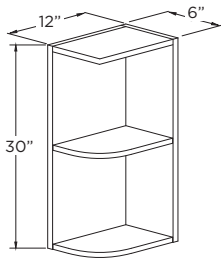

ITEM	PRICE	ITEM	PRICE
1 Shelf		3 Shelves	
EWES1218	389	EWES1242	724
2 Shelves		EWES1248	883
EWES1221	440	4 Shelves	
EWES1224	463	EWES1254	1113
EWES1230	565	EWES1257	1171
EWES1233	593	EWES1260	1232
EWES1236	622		
EWES1239	674		

## WINE WALL STORAGE CUBE

- Finished Interior & Exterior

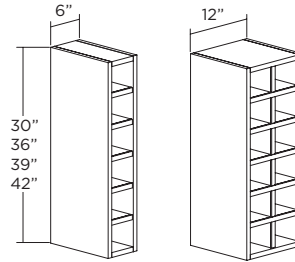

6" WIDE	PRICE	# OF CUBES
EWWSC630	1023	6
EWWSC636	1133	7
EWWSC639	1183	7
EWWSC642	1234	8

12" WIDE	PRICE	# OF CUBES
EWWSC1230	1292	12
EWWSC1236	1394	14
EWWSC1239	1438	14
EWWSC1242	1483	16

## WALL WINE LATTICE

- Finished Interior
- Wood Lattice is not available in foil.

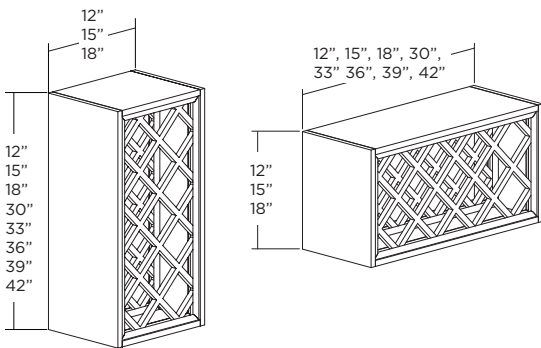

12" HIGH	PRICE	# OF SLOTS	33" HIGH	PRICE	# OF SLOTS
EWWL3012	782	7	EWWL1233	841	8
EWWL3312	841	8	EWWL1533	933	12
EWWL3612	895	9	EWWL1833	1049	16

15" HIGH	PRICE	# OF SLOTS	36" HIGH	PRICE	# OF SLOTS
EWWL3015	868	10	EWWL1236	895	9
EWWL3315	933	12	EWWL1536	993	13
EWWL3615	993	13	EWWL1836	1122	18

18" HIGH	PRICE	# OF SLOTS	39" HIGH	PRICE	# OF SLOTS
EWWL3018	976	14	EWWL1239	958	10
EWWL3318	1049	16	EWWL1539	1029	15
EWWL3618	1122	18	EWWL1839	1096	20

30" HIGH	PRICE	# OF SLOTS	42" HIGH	PRICE	# OF SLOTS
EWWL1230	782	7	EWWL1242	1025	11
EWWL1530	868	11	EWWL1542	1102	16
EWWL1830	976	16	EWWL1842	1173	22

## WINE WALL - STYLE X

- Finished Interior
- Installation of cabinet must be between two cabinets or a cabinet and a wall as additional support is recommended for this cabinet.

### 4 BOTTLE OPENINGS

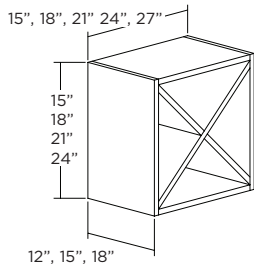

15" HIGH	PRICE	18" HIGH	PRICE	21" HIGH	PRICE	24" HIGH	PRICE
EWWX151512	1081	EWWX151812	1103	EWWX152112	1123	EWWX152412	1146
EWWX151515	1179	EWWX151815	1203	EWWX152115	1225	EWWX152415	1250
EWWX151518	1269	EWWX151818	1294	EWWX152118	1318	EWWX152418	1345
EWWX181512	1136	EWWX181812	1158	EWWX182112	1181	EWWX182412	1204
EWWX181515	1240	EWWX181815	1264	EWWX182115	1289	EWWX182415	1314
EWWX181518	1334	EWWX181818	1358	EWWX182118	1387	EWWX182418	1414
EWWX211512	1205	EWWX211812	1231	EWWX212112	1255	EWWX212412	1278
EWWX211515	1315	EWWX211815	1343	EWWX212115	1369	EWWX212415	1394
EWWX211518	1415	EWWX211818	1445	EWWX212118	1473	EWWX212418	1500
EWWX241512	1337	EWWX241812	1363	EWWX242112	1392	EWWX242412	1418
EWWX241515	1459	EWWX241815	1487	EWWX242115	1518	EWWX242415	1547
EWWX241518	1570	EWWX241818	1600	EWWX242118	1634	EWWX242418	1665
EWWX271512	1468	EWWX271812	1496	EWWX272112	1528	EWWX272412	1557
EWWX271515	1601	EWWX271815	1632	EWWX272115	1667	EWWX272415	1699
EWWX271518	1723	EWWX271818	1756	EWWX272118	1794	EWWX272418	1828

### 8 BOTTLE OPENINGS

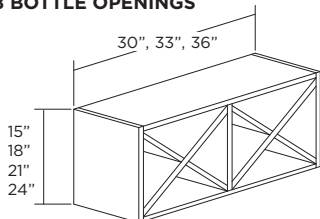

15" HIGH	PRICE	18" HIGH	PRICE	21" HIGH	PRICE	24" HIGH	PRICE
EWWX301512	2052	EWWX301812	2132	EWWX302112	2092	EWWX302412	2172
EWWX301515	2239	EWWX301815	2326	EWWX302115	2282	EWWX302415	2369
EWWX301518	2409	EWWX301818	2503	EWWX302118	2456	EWWX302418	2550
EWWX331512	2122	EWWX331812	2207	EWWX332112	2163	EWWX332412	2249
EWWX331515	2315	EWWX331815	2408	EWWX332115	2360	EWWX332415	2454
EWWX331518	2491	EWWX331818	2591	EWWX332118	2540	EWWX332418	2640
EWWX361512	2188	EWWX361812	2273	EWWX362112	2230	EWWX362412	2317
EWWX361515	2387	EWWX361815	2480	EWWX362115	2433	EWWX362415	2528
EWWX361518	2568	EWWX361818	2669	EWWX362118	2618	EWWX362418	2720

# ELAN WALL SPECIALTY CABINETS

## WALL ORGANIZER - STYLE A

- Finished Interior Lower Section

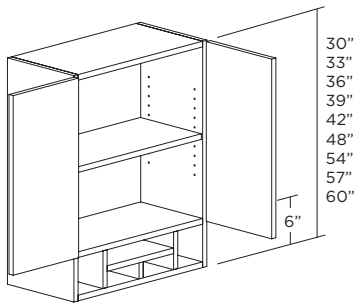

30" HIGH	A	B	C	D	E	F	G
1 Adjustable Shelf							
EWO2430-2	1064	1117	1170	1224	1309	1362	1425
EWO2730	1114	1170	1226	1281	1370	1427	1493
EWO3030	1159	1216	1275	1334	1427	1484	1554
EWO3330	1204	1264	1325	1385	1482	1542	1614
EWO3630	1246	1308	1370	1433	1533	1595	1670

33" HIGH	A	B	C	D	E	F	G
2 Adjustable Shelves							
EWO2433-2	1076	1129	1183	1238	1324	1377	1441
EWO2733	1126	1183	1239	1296	1385	1443	1509
EWO3033	1172	1230	1289	1349	1442	1500	1571
EWO3333	1217	1278	1340	1400	1499	1559	1632
EWO3633	1259	1322	1386	1449	1550	1613	1689

36" HIGH	A	B	C	D	E	F	G
2 Adjustable Shelves							
EWO2436-2	1090	1145	1200	1254	1342	1396	1462
EWO2736	1139	1197	1254	1311	1402	1458	1527
EWO3036	1183	1242	1302	1362	1456	1516	1587
EWO3336	1230	1291	1353	1414	1513	1575	1649
EWO3636	1289	1353	1418	1483	1586	1650	1727

39" HIGH	A	B	C	D	E	F	G
2 Adjustable Shelves							
EWO2439-2	1128	1185	1242	1298	1389	1445	1512
EWO2739	1175	1234	1293	1352	1446	1505	1575
EWO3039	1221	1282	1344	1405	1502	1564	1637
EWO3339	1267	1330	1394	1457	1559	1622	1698
EWO3639	1326	1392	1460	1526	1632	1698	1778

42" HIGH	A	B	C	D	E	F	G
2 Adjustable Shelves							
EWO2442-2	1166	1225	1284	1342	1435	1494	1564
EWO2742	1213	1274	1335	1395	1493	1553	1626
EWO3042	1259	1323	1385	1449	1549	1612	1688
EWO3342	1306	1370	1436	1502	1606	1672	1751
EWO3642	1364	1433	1501	1570	1678	1747	1829

48" HIGH	A	B	C	D	E	F	G
2 Adjustable Shelves							
EWO2448-2	1246	1308	1371	1434	1533	1596	1671
EWO2748	1296	1361	1426	1490	1595	1659	1736
EWO3048	1345	1414	1479	1548	1654	1722	1802
EWO3348	1395	1463	1533	1604	1715	1787	1870
EWO3648	1458	1530	1604	1677	1792	1867	1953

54" HIGH	A	B	C	D	E	F	G
3 Adjustable Shelves							
EWO2454-2	1340	1407	1475	1542	1649	1717	1797
EWO2754	1394	1464	1534	1603	1715	1784	1867
EWO3054	1447	1521	1591	1665	1779	1852	1939
EWO3354	1500	1574	1649	1725	1845	1922	2011
EWO3654	1568	1646	1725	1804	1928	2008	2101

57" HIGH	A	B	C	D	E	F	G
3 Adjustable Shelves							
EWO2457-2	1386	1455	1525	1595	1705	1775	1858
EWO2757	1441	1513	1586	1657	1774	1845	1931
EWO3057	1496	1572	1645	1722	1840	1915	2005
EWO3357	1551	1627	1705	1784	1907	1987	2080
EWO3657	1621	1702	1784	1866	1993	2077	2172

60" HIGH	A	B	C	D	E	F	G
3 Adjustable Shelves							
EWO2460-2	1433	1505	1577	1649	1763	1836	1921
EWO2760	1490	1565	1640	1713	1834	1907	1997
EWO3060	1547	1626	1701	1780	1902	1980	2073
EWO3360	1604	1683	1763	1844	1972	2055	2150
EWO3660	1676	1760	1845	1929	2061	2147	2246



# ELAN WALL SPECIALTY CABINETS

## WALL ORGANIZER - STYLE B

- Finished Interior Lower Section

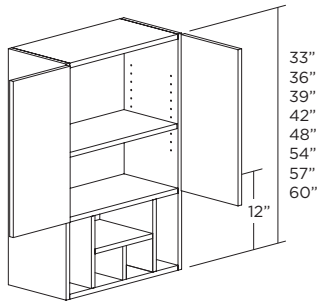

33" HIGH	A	B	C	D	E	F	G
1 Adjustable Shelves							
EWOB2433-2	1034	1086	1138	1190	1274	1324	1387
EWOB2733	1093	1147	1202	1257	1344	1398	1466
EWOB3033	1127	1185	1242	1298	1387	1445	1513
EWOB3333	1181	1240	1300	1360	1453	1513	1583
EWOB3633	1224	1285	1347	1408	1506	1567	1640

36" HIGH	A	B	C	D	E	F	G
1 Adjustable Shelves							
EWOB2436-2	1070	1123	1177	1231	1317	1369	1434
EWOB2736	1130	1186	1243	1300	1390	1446	1515
EWOB3036	1166	1225	1284	1342	1435	1494	1564
EWOB3336	1221	1282	1344	1405	1502	1564	1637
EWOB3636	1265	1329	1392	1456	1557	1620	1696

39" HIGH	A	B	C	D	E	F	G
1 Adjustable Shelves							
EWOB2439-2	1106	1161	1218	1273	1362	1417	1483
EWOB2739	1165	1224	1282	1340	1434	1491	1562
EWOB3039	1203	1263	1324	1384	1480	1540	1612
EWOB3339	1258	1320	1384	1447	1548	1611	1686
EWOB3639	1301	1366	1432	1496	1600	1665	1743

42" HIGH	A	B	C	D	E	F	G
2 Adjustable Shelves							
EWOB2442-2	1141	1198	1256	1312	1403	1461	1529
EWOB2742	1200	1260	1322	1381	1477	1537	1609
EWOB3042	1247	1309	1373	1436	1536	1598	1672
EWOB3342	1292	1357	1422	1487	1590	1654	1732
EWOB3642	1336	1403	1471	1537	1644	1712	1791

48" HIGH	A	B	C	D	E	F	G
2 Adjustable Shelves							
EWOB2448-2	1220	1281	1343	1405	1502	1564	1635
EWOB2748	1286	1350	1415	1479	1582	1645	1724
EWOB3048	1327	1393	1461	1527	1633	1699	1779
EWOB3348	1388	1456	1527	1597	1708	1777	1860
EWOB3648	1435	1507	1580	1651	1766	1837	1922

54" HIGH	A	B	C	D	E	F	G
2 Adjustable Shelves							
EWOB2454-2	1304	1369	1436	1502	1606	1672	1748
EWOB2754	1374	1443	1512	1581	1691	1759	1843
EWOB3054	1418	1489	1562	1632	1745	1817	1902
EWOB3354	1483	1556	1632	1707	1825	1900	1989
EWOB3654	1534	1611	1690	1765	1888	1963	2055

57" HIGH	A	B	C	D	E	F	G
3 Adjustable Shelves							
EWOB2457-2	1403	1473	1546	1616	1728	1799	1882
EWOB2757	1479	1553	1628	1702	1820	1893	1983
EWOB3057	1526	1603	1681	1757	1878	1955	2047
EWOB3357	1597	1675	1757	1837	1965	2045	2140
EWOB3657	1651	1734	1818	1900	2032	2113	2212

60" HIGH	A	B	C	D	E	F	G
3 Adjustable Shelves							
EWOB2460-2	1500	1575	1652	1728	1848	1923	2011
EWOB2760	1581	1660	1740	1820	1946	2024	2120
EWOB3060	1632	1713	1797	1878	2008	2090	2188
EWOB3360	1707	1790	1878	1964	2100	2186	2288
EWOB3660	1765	1853	1944	2031	2172	2259	2365

# ELAN WALL SPECIALTY CABINETS

## WALL ORGANIZER FULL HEIGHT DOORS STYLE A

- Finished Interior

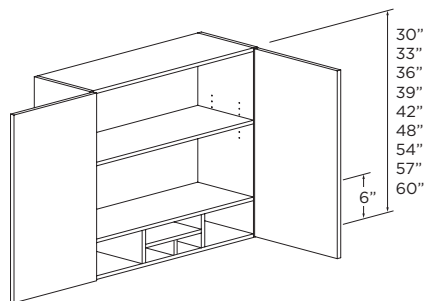

30" HIGH	A	B	C	D	E	F	G
1 Adjustable Shelf							
EWO2430FHD-2	1098	1153	1208	1263	1351	1406	1472
EWO2730FHD	1148	1205	1263	1320	1412	1469	1539
EWO3030FHD	1193	1253	1313	1373	1468	1528	1599
EWO3330FHD	1238	1301	1363	1424	1523	1586	1660
EWO3630FHD	1281	1345	1410	1474	1577	1641	1718

33" HIGH	A	B	C	D	E	F	G
1 Adjustable Shelf							
EWO2433FHD-2	1115	1170	1226	1281	1372	1427	1494
EWO2733FHD	1165	1223	1282	1340	1433	1491	1562
EWO3033FHD	1211	1272	1333	1394	1491	1552	1623
EWO3333FHD	1256	1320	1384	1446	1546	1611	1686
EWO3633FHD	1300	1365	1432	1496	1601	1665	1745

36" HIGH	A	B	C	D	E	F	G
1 Adjustable Shelves							
EWO2436FHD-2	1123	1180	1236	1292	1383	1439	1506
EWO2736FHD	1175	1234	1293	1352	1446	1505	1575
EWO3036FHD	1218	1279	1340	1401	1499	1559	1632
EWO3336FHD	1264	1328	1391	1455	1555	1619	1694
EWO3636FHD	1324	1390	1457	1523	1630	1696	1775

39" HIGH	A	B	C	D	E	F	G
1 Adjustable Shelves							
EWO2439FHD-2	1161	1220	1278	1336	1429	1487	1556
EWO2739FHD	1220	1281	1342	1403	1501	1562	1636
EWO3039FHD	1257	1319	1383	1446	1546	1609	1685
EWO3339FHD	1303	1368	1434	1499	1604	1669	1747
EWO3639FHD	1362	1430	1499	1567	1676	1743	1825

42" HIGH	A	B	C	D	E	F	G
2 Adjustable Shelves							
EWO2442FHD-2	1211	1273	1334	1394	1490	1551	1623
EWO2742FHD	1259	1322	1385	1449	1549	1612	1688
EWO3042FHD	1306	1370	1436	1502	1606	1672	1751
EWO3342FHD	1352	1419	1488	1555	1664	1731	1813
EWO3642FHD	1412	1483	1554	1625	1737	1808	1892

48" HIGH	A	B	C	D	E	F	G
3 Adjustable Shelves							
EWO2448FHD-2	1295	1360	1425	1490	1592	1656	1733
EWO2748FHD	1345	1413	1479	1548	1656	1722	1802
EWO3048FHD	1392	1463	1534	1604	1715	1785	1870
EWO3348FHD	1445	1516	1589	1662	1777	1850	1936
EWO3648FHD	1509	1584	1660	1736	1855	1931	2022

54" HIGH	A	B	C	D	E	F	G
3 Adjustable Shelves							
EWO2454FHD-2	1383	1452	1522	1591	1700	1769	1851
EWO2754FHD	1437	1509	1580	1653	1768	1839	1925
EWO3054FHD	1487	1563	1638	1713	1832	1907	1997
EWO3354FHD	1544	1619	1697	1775	1898	1975	2068
EWO3654FHD	1612	1692	1773	1855	1981	2063	2159

57" HIGH	A	B	C	D	E	F	G
4 Adjustable Shelves							
EWO2457FHD-2	1430	1501	1573	1646	1758	1829	1914
EWO2757FHD	1486	1560	1633	1710	1828	1902	1990
EWO3057FHD	1538	1616	1694	1771	1894	1972	2065
EWO3357FHD	1596	1674	1755	1835	1962	2043	2138
EWO3657FHD	1666	1750	1834	1918	2049	2133	2233

60" HIGH	A	B	C	D	E	F	G
4 Adjustable Shelves							
EWO2460FHD-2	1479	1552	1627	1701	1818	1891	1979
EWO2760FHD	1536	1613	1689	1768	1890	1966	2058
EWO3060FHD	1590	1671	1751	1831	1958	2039	2136
EWO3360FHD	1650	1731	1814	1897	2029	2112	2211
EWO3660FHD	1723	1809	1896	1983	2118	2205	2308

**DESIGN NOTES:** Doors will be constructed with a horizontal center rail and equally sized panels over 48" high.

# ELAN WALL SPECIALTY CABINETS

## WALL ORGANIZER FULL HEIGHT DOORS STYLE B

- Finished Interior

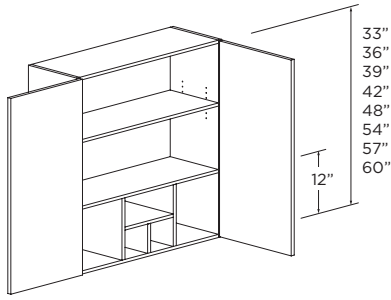

33" HIGH	A	B	C	D	E	F	G
1 Adjustable Shelf							
EWOB2433FHD-2	1180	1239	1299	1358	1454	1511	1583
EWOB2733FHD	1244	1306	1369	1432	1531	1592	1668
EWOB3033FHD	1285	1349	1415	1479	1581	1646	1723
EWOB3333FHD	1343	1411	1479	1547	1653	1721	1801
EWOB3633FHD	1391	1461	1531	1601	1712	1781	1864

36" HIGH	A	B	C	D	E	F	G
1 Adjustable Shelf							
EWOB2436FHD-2	1218	1279	1340	1401	1499	1559	1632
EWOB2736FHD	1284	1348	1412	1477	1579	1643	1720
EWOB3036FHD	1326	1392	1460	1526	1632	1698	1778
EWOB3336FHD	1386	1456	1526	1595	1705	1775	1858
EWOB3636FHD	1435	1507	1579	1652	1767	1837	1924

39" HIGH	A	B	C	D	E	F	G
2 Adjustable Shelves							
EWOB2439FHD-2	1258	1320	1384	1447	1548	1611	1686
EWOB2739FHD	1324	1390	1457	1523	1630	1696	1775
EWOB3039FHD	1366	1434	1502	1571	1680	1748	1830
EWOB3339FHD	1427	1498	1570	1642	1756	1826	1912
EWOB3639FHD	1476	1549	1623	1698	1815	1889	1978

42" HIGH	A	B	C	D	E	F	G
2 Adjustable Shelves							
EWOB2442FHD-2	1308	1374	1439	1505	1610	1675	1753
EWOB2742FHD	1375	1444	1513	1582	1692	1760	1844
EWOB3042FHD	1400	1469	1540	1610	1723	1792	1877
EWOB3342FHD	1478	1551	1626	1700	1819	1892	1982
EWOB3642FHD	1527	1603	1680	1757	1879	1955	2046

48" HIGH	A	B	C	D	E	F	G
2 Adjustable Shelves							
EWOB2448FHD-2	1404	1475	1545	1618	1730	1800	1883
EWOB2748FHD	1477	1551	1626	1700	1818	1891	1981
EWOB3048FHD	1504	1578	1655	1729	1851	1925	2016
EWOB3348FHD	1588	1666	1748	1826	1954	2033	2129
EWOB3648FHD	1641	1723	1805	1888	2019	2100	2198

54" HIGH	A	B	C	D	E	F	G
3 Adjustable Shelves							
EWOB2454FHD-2	1518	1594	1670	1748	1869	1946	2035
EWOB2754FHD	1597	1677	1757	1838	1965	2044	2141
EWOB3054FHD	1625	1705	1789	1869	2000	2080	2179
EWOB3354FHD	1716	1801	1889	1973	2112	2197	2301
EWOB3654FHD	1773	1862	1951	2041	2182	2270	2376

57" HIGH	A	B	C	D	E	F	G
3 Adjustable Shelves							
EWOB2457FHD-2	1566	1645	1724	1804	1929	2008	2100
EWOB2757FHD	1648	1730	1813	1896	2028	2109	2210
EWOB3057FHD	1677	1760	1846	1929	2064	2147	2249
EWOB3357FHD	1771	1858	1949	2037	2180	2267	2375
EWOB3657FHD	1830	1921	2014	2106	2252	2342	2452

60" HIGH	A	B	C	D	E	F	G
3 Adjustable Shelves							
EWOB2460FHD-2	1617	1697	1779	1862	1991	2072	2168
EWOB2760FHD	1701	1786	1871	1957	2093	2177	2280
EWOB3060FHD	1731	1816	1905	1990	2130	2215	2321
EWOB3360FHD	1828	1918	2012	2102	2249	2340	2451
EWOB3660FHD	1888	1983	2078	2173	2324	2417	2530

**DESIGN NOTES:** Doors will be constructed with a horizontal center rail and equally sized panels over 48" high.

# ELAN WALL SPECIALTY CABINETS

## WALL MICROWAVE - STYLE A

- Microwave cabinet shipped with solid panel.
- Specify Appliance Cutout, if Needed, No Charge
- When Changing Height, the Upper Section Changes

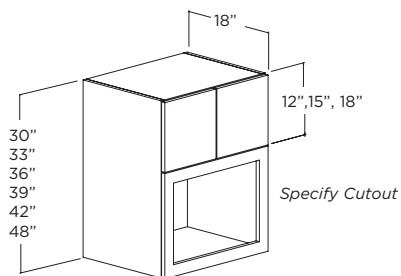

Max. Cutout: 3" Less Than Cabinet Width

STYLE A	A	B	C	D	E	F	G
<b>30" HIGH</b>							
EWMA2430	1413	1468	1523	1578	1666	1720	1786
EWMA2730	1467	1525	1582	1640	1732	1790	1858
EWMA3030	1504	1563	1622	1682	1778	1836	1907
EWMA3330	1255	1602	1663	1725	1824	1884	1957
<b>33" HIGH</b>							
EWMA2433	1484	1543	1602	1660	1753	1811	1882
EWMA2733	1542	1604	1664	1726	1824	1886	1958
EWMA3033	1581	1644	1706	1771	1873	1934	2010
EWMA3333	1334	1685	1751	1816	1921	1986	2064
<b>36" HIGH</b>							
EWMA2436	1555	1618	1680	1741	1840	1902	1977
EWMA2736	1621	1686	1752	1817	1922	1987	2065
EWMA3036	1649	1715	1783	1850	1956	2022	2103
EWMA3336	1678	1744	1813	1881	1991	2058	2139
<b>39" HIGH</b>							
EWMA2439	1644	1710	1778	1844	1950	2016	2096
EWMA2739	1702	1772	1841	1910	2021	2089	2173
EWMA3039	1748	1820	1891	1963	2078	2149	2235
EWMA3339	1797	1870	1944	2019	2138	2211	2235
<b>42" HIGH</b>							
EWMA2442	1732	1803	1874	1945	2059	2129	2214
EWMA2742	1784	1857	1930	2004	2121	2195	2283
EWMA3042	1847	1924	2001	2077	2199	2276	2368
EWMA3342	1915	1995	2075	2156	2283	2364	2459
<b>48" HIGH</b>							
EWMA2448	1827	1902	1979	2055	2177	2251	2341
EWMA2748	1883	1961	2038	2117	2242	2321	2415
EWMA3048	1950	2032	2114	2196	2327	2409	2506
EWMA3348	2022	2107	2193	2279	2415	2501	2603

## WALL MICROWAVE - STYLE B

- 12" deep with 18" deep open shelf
- Finished Interior
- Specify Appliance Cutout, if Needed, No Charge
- When Changing Height, the Upper Section Changes

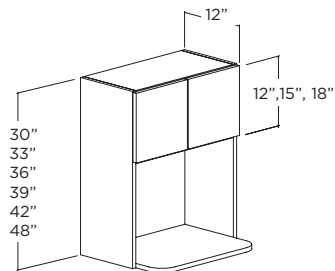

STYLE B	A	B	C	D	E	F	G
<b>30" HIGH</b>							
EWMB2430	994	1044	1094	1143	1223	1273	1333
EWMB2730	1043	1095	1148	1199	1284	1335	1399
EWMB3030	1087	1141	1196	1251	1337	1391	1457
EWMB3330	1137	1192	1250	1307	1397	1453	1523
<b>33" HIGH</b>							
EWMB2433	1079	1133	1187	1240	1326	1381	1447
EWMB2733	1132	1188	1245	1301	1393	1448	1517
EWMB3033	1179	1238	1298	1357	1451	1509	1581
EWMB3333	1233	1294	1356	1418	1516	1577	1652
<b>36" HIGH</b>							
EWMB2436	1161	1220	1278	1336	1429	1487	1556
EWMB2736	1227	1289	1351	1412	1510	1572	1645
EWMB3036	1280	1344	1408	1473	1575	1639	1715
EWMB3336	1344	1412	1479	1546	1654	1722	1802
<b>39" HIGH</b>							
EWMB2439	1240	1302	1364	1427	1526	1587	1661
EWMB2739	1312	1378	1444	1509	1614	1680	1758
EWMB3039	1383	1452	1522	1590	1702	1770	1853
EWMB3339	1462	1533	1607	1679	1797	1871	1957
<b>42" HIGH</b>							
EWMB2442	1315	1381	1447	1513	1619	1685	1763
EWMB2742	1397	1467	1538	1608	1719	1790	1873
EWMB3042	1485	1560	1634	1709	1828	1902	1991
EWMB3342	1578	1658	1736	1817	1944	2023	2116
<b>48" HIGH</b>							
EWMB2448	1395	1465	1536	1606	1717	1788	1871
EWMB2748	1482	1556	1631	1707	1824	1900	1987
EWMB3048	1575	1656	1733	1813	1940	2018	2113
EWMB3348	1675	1760	1843	1929	2063	2147	2246

# ELAN WALL SPECIALTY CABINETS

## WALL MICROWAVE - STYLE C

- Microwave cabinet shipped with solid panel.
- Specify Appliance Cutout, if Needed, No Charge
- When Changing Height, the Upper Section Changes

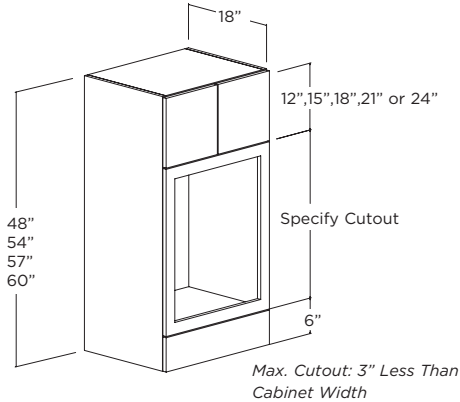

STYLE C	A	B	C	D	E	F	G
<b>48" HIGH</b>							
EWMC2448	1833	1908	1984	2060	2181	2257	2349
EWMC2748	1891	1970	2049	2129	2254	2333	2427
EWMC3048	1954	2036	2118	2199	2330	2412	2510
EWMC3348	2020	2105	2190	2274	2410	2496	2598
<b>54" HIGH</b>							
EWMC2454	2031	2115	2201	2287	2424	2500	2614
EWMC2754	2096	2185	2274	2364	2506	2595	2702
EWMC3054	2167	2259	2353	2444	2591	2685	2795
EWMC3354	2241	2337	2434	2529	2682	2779	2894
<b>57" HIGH</b>							
EWMC2457	2152	2242	2335	2427	2573	2666	2777
EWMC2757	2222	2317	2413	2509	2661	2757	2871
EWMC3057	2298	2397	2497	2595	2753	2853	2971
EWMC3357	2377	2480	2584	2686	2850	2954	3077
<b>60" HIGH</b>							
EWMC2460	2275	2371	2470	2568	2724	2823	2942
EWMC2760	2350	2451	2554	2656	2818	2921	3042
EWMC3060	2431	2537	2643	2747	2916	3022	3149
EWMC3360	2515	2625	2736	2845	3020	3131	3262

## PULL-OUT SPICE RACK

- Accessible From Both Sides
- Full Extension Glides
- Adjustable Shelves
- Decrease Depth Not Available

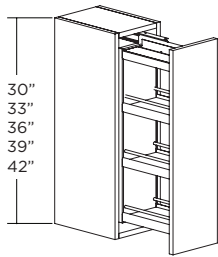

30" HIGH	A	B	C	D	E	F	G
3 Adjustable Shelves							
EPSR930	791	830	870	911	973	1013	1060
EPSR1230	824	866	907	949	1015	1055	1105
EPSR1530	850	892	935	978	1045	1088	1139

33" HIGH	A	B	C	D	E	F	G
3 Adjustable Shelves							
EPSR933	861	903	946	991	1058	1102	1153
EPSR1233	896	942	987	1032	1104	1148	1202
EPSR1533	925	970	1018	1064	1137	1184	1239

36" HIGH	A	B	C	D	E	F	G
3 Adjustable Shelves							
EPSR936	949	996	1044	1092	1167	1215	1271
EPSR1236	980	1029	1079	1128	1207	1256	1314
EPSR1536	1007	1057	1109	1159	1240	1290	1351

39" HIGH	A	B	C	D	E	F	G
3 Adjustable Shelves							
EPSR939	1033	1084	1137	1188	1271	1323	1385
EPSR1239	1061	1114	1167	1220	1306	1359	1422
EPSR1539	1087	1140	1196	1251	1338	1392	1457

42" HIGH	A	B	C	D	E	F	G
4 Adjustable Shelves							
EPSR942	1112	1169	1224	1280	1369	1424	1491
EPSR1242	1138	1196	1253	1309	1401	1457	1526
EPSR1542	1169	1227	1286	1345	1438	1496	1567

## WALL PULL-OUT FILLER

- 12" Deep (Including the Front Filler)
- Must be Installed Between Cabinets.
- Specify Shelves (L or R) on 3" Wide
- 3" Wide - Accessible from one side.
- 6" Wide - Accessible from both sides.
- Decrease Depth Not Available

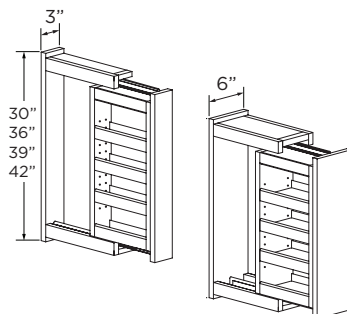

30" HIGH	PRICE
3 Adjustable Shelves	
EWPOF330	654
EWPOF630	817

39" HIGH	PRICE
4 Adjustable Shelves	
EWPOF339	863
EWPOF639	1078

36" HIGH	PRICE
3 Adjustable Shelves	
EWPOF336	784
EWPOF636	979

42" HIGH	PRICE
4 Adjustable Shelves	
EWPOF342	940
EWPOF642	1175

**DESIGN NOTE:** Attach an overlay filler or split turning to the front for a designer look.

# ELAN WALL SPECIALTY CABINETS

## WALL SPICE RACK

- Wood spice rack mounted on back of door
- 2-Reduced depth adjustable shelves inside cabinet
- Specify Hinge (L or R)

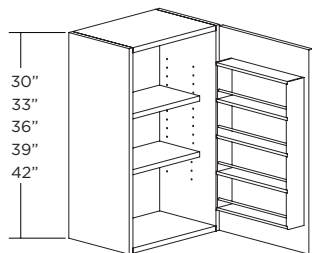

30" HIGH	A	B	C	D	E	F	G
2 Adjustable Shelves							
EWSR1530	835	877	919	961	1028	1070	1120
EWSR1830	869	913	957	1000	1070	1114	1165
33" HIGH	A	B	C	D	E	F	G
2 Adjustable Shelves							
EWSR1533	874	917	961	1005	1075	1119	1171
EWSR1833	909	955	1001	1046	1119	1165	1219
36" HIGH	A	B	C	D	E	F	G
2 Adjustable Shelves							
EWSR1536	877	921	965	1009	1078	1122	1175
EWSR1836	911	956	1002	1048	1121	1166	1221
39" HIGH	A	B	C	D	E	F	G
3 Adjustable Shelves							
EWSR1539	917	963	1009	1055	1128	1174	1229
EWSR1839	951	999	1046	1094	1170	1218	1275
42" HIGH	A	B	C	D	E	F	G
3 Adjustable Shelves							
EWSR1542	958	1006	1055	1103	1180	1227	1285
EWSR1842	991	1042	1092	1141	1220	1270	1329

## WALL CONDIMENT DRAWERS

- Condiment drawers are available in standard wood species only.

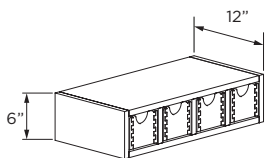

ITEM	PRICE	DRAWERS
EWCND18-3	488	3
EWCND24-4	577	4
EWCND30-5	691	5
EWCND36-6	779	6

## DESK ORGANIZER

- Finished Interior & Exterior

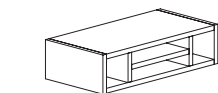

**6" High x 9" Deep**  
24"W - 27"W

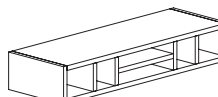

**6" High x 9" Deep**  
30"W - 36"W

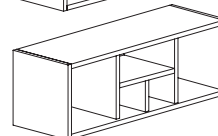

**12" High x 12" Deep**  
24"W - 36"W

ITEM	PRICE
EDO24	444
EDO27	468
EDO30	548
EDO33	570
EDO36	593
EDOB24	589
EDOB27	621
EDOB30	649
EDOB33	676
EDOB36	705

## SPICE RACK DOOR

- Birch Natural

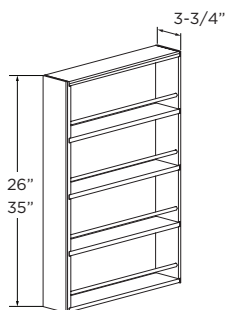

26" HIGH	ACTUAL WIDTH	PRICE
Fits a 30"H & 36"H Cabinet		
SRD15	9-1/2"	285
SRD18	12-1/2"	
SRD21	15-1/2"	
SRD24	18-1/2"	

35" HIGH	ACTUAL WIDTH	PRICE
Fits a 39"H & 42"H		
SRD15T	9-1/2"	325
SRD18T	12-1/2"	
SRD21T	15-1/2"	
SRD24T	18-1/2"	

## WOOD FLOATING SHELF

- Includes Mounting Hardware
- Cut down depth and width at no charge. If depth is less than 10-1/2", steel bracket must be field cut.
- Mounting hardware must be attached to wall studs.
- Weight Capacity: 5 lbs/lineal ft.
- Not Available in Laminates or Foils

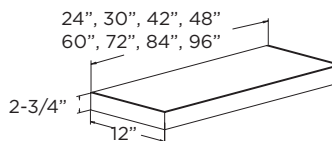

12" DEEP	PRICE
FS2412	340
FS3012	352
FS3612	366
FS4212	378
FS4812	395
FS6012	704
FS7212	731
FS8412	756
FS9612	802

## STEMWARE HOLDER

- Sized for Installation Under Standard Wall Cabinets

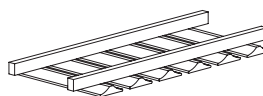

ITEM	PRICE	SLOTS	ACTUAL WIDTH
ESH15	399	3	15
ESH18		3	18
ESH21	521	4	21
ESH24		4	24
ESH27	725	5	27
ESH30		6	30
ESH33		6	33
ESH36		7	36



**TABLE OF CONTENTS**

**ELAN WOOD HOODS ..... E400-1 THRU E400-10**

Wood Hood Box Style.....E400-2  
Wood Hood Box Arch Style.....E400-3  
Wood Hood with Flare Canopy .....E400-4  
Wood Hood with Curved Canopy .....E400-5  
Wood Hood Style A, AA, and O.....E400-6  
Wood Hood Modern.....E400-7  
Wood Hood Independent Modern.....E400-8  
Liner Information/Reference Page .....E400-9



# ELAN WOOD HOODS

## WOOD HOOD BOX STYLE (WHBX)

- Hoods are available in standard wood species only.
- Box hoods are available in 2 depths. 23-3/8"D hood use "Professional Series" blower.
- For paneled hoods, Insert Panels will match the door style.
- Vent-A-Hood liner and blower is included and shipped loose. See liner/blower chart on page 400-9 for detailed specs.
- Modifications are limited. Call for availability and quote.
- Dealer is responsible for compliance with local building codes (ventilation, installation, clearances and liner width). As a guideline, hoods are recommended for installation 30" above cooking surface, and liner width should be same width or wider than cooking surface.

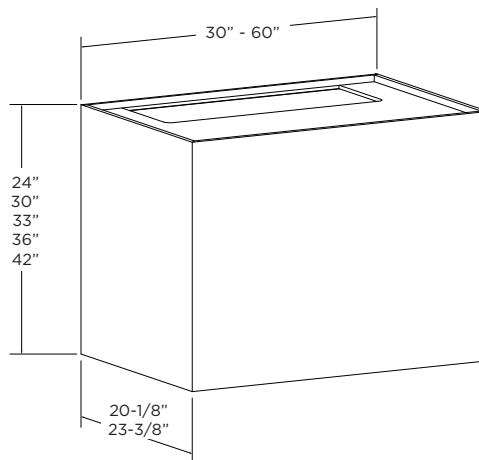

20" DEEP	PRICE	LINER WIDTH	CFM	LINER INFO <i>See Page 400-9</i>
<b>24" HIGH</b>				
WHBX3024	2674	28-3/8"	300	A
WHBX3624	2739	34-3/8"	600	D
WHBX4224	3682	40-3/8"	600	E
WHBX4824	4052	46-3/8"	600	F
<b>30" HIGH</b>				
WHBX3030	2744	28-3/8"	300	A
WHBX3630	2816	34-3/8"	600	D
WHBX4230	3767	40-3/8"	600	E
WHBX4830	4145	46-3/8"	600	F
<b>33" HIGH</b>				
WHBX3033*	2778	28-3/8"	300	A
WHBX3633*	2855	34-3/8"	600	D
WHBX4233*	3809	40-3/8"	600	E
WHBX4833*	4191	46-3/8"	600	F
<b>36" HIGH</b>				
WHBX3036	2813	28-3/8"	300	A
WHBX3636	2893	34-3/8"	600	D
WHBX4236	3852	40-3/8"	600	E
WHBX4836	4237	46-3/8"	600	F
<b>42" HIGH</b>				
WHBX3042	2881	28-3/8"	300	A
WHBX3642	2970	34-3/8"	600	D
WHBX4242	3936	40-3/8"	600	E
WHBX4842	4330	46-3/8"	600	F

24" DEEP	PRICE	LINER WIDTH	CFM	LINER INFO <i>See Page 400-9</i>
<b>30" HIGH</b>				
WHBX3030-24	3427	28-3/8"	600	G
WHBX3630-24	3502	34-3/8"	600	H
WHBX4230-24	3838	40-3/8"	600	I
WHBX4830-24	4891	46-3/8"	600	J
WHBX5430-24	6387	52-3/8"	1200	K
WHBX6030-24	7255	58-3/8"	1200	L
<b>36" HIGH</b>				
WHBX3036-24	3501	28-3/8"	600	G
WHBX3636-24	3584	34-3/8"	600	H
WHBX4236-24	3927	40-3/8"	600	I
WHBX4836-24	4989	46-3/8"	600	J
WHBX5436-24	6492	46-3/8"	1200	K
WHBX6036-24	7369	46-3/8"	1200	L
<b>42" HIGH</b>				
WHBX3042-24	3575	28-3/8"	600	G
WHBX3642-24	3665	34-3/8"	600	H
WHBX4242-24	4017	40-3/8"	600	I
WHBX4842-24	5086	46-3/8"	600	J
WHBX5442-24	6598	46-3/8"	1200	K
WHBX6042-24	7483	46-3/8"	1200	L

### WOOD HOODS BOX STYLE WITH PANELS (WHBXP)

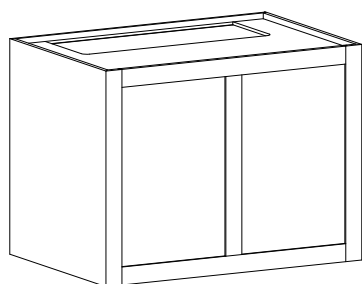

### WOOD HOODS BOX STYLE WITH SHIPLAP (WHBXS)

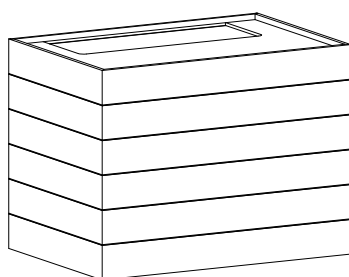

### WOOD HOODS BOX STYLE WITH CORBELS (WHBXC)

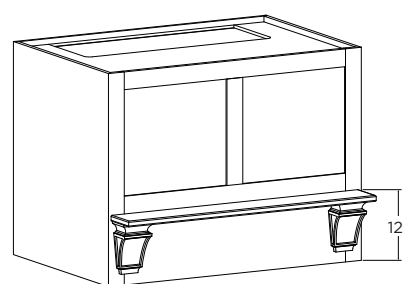

For Box Hood with Panels, Shiplap or Corbels specify the appropriate code and add to the base price.

WHBXP (Panels).....Add \$385

WHBXS (Shiplap).....Add \$167

WHBXC (Corbels).....Add \$1,651



## WOOD HOOD BOX ARCH STYLE (WHBXA)

- Hoods are available in standard wood species only.
- Box hoods are available in 2 depths. 23-3/8" D hood use "Professional Series" blower.
- For paneled hoods, Insert Panels will match the door style.
- Vent-A-Hood liner and blower is included and shipped loose. See liner/blower chart on page 400-9 for detailed specs.
- Modifications are limited. Call for availability and quote.
- Dealer is responsible for compliance with local building codes (ventilation, installation, clearances and liner width). As a guideline, hoods are recommended for installation 30" above cooking surface, and liner width should be same width or wider than cooking surface.

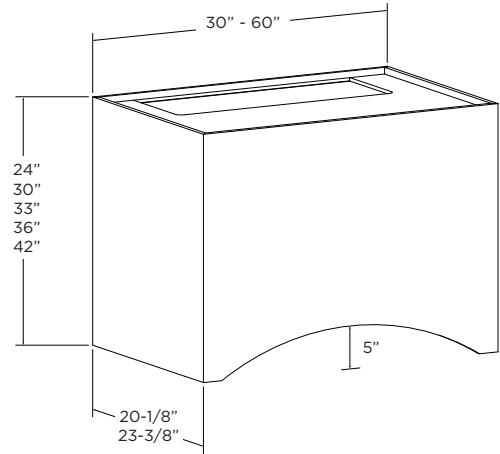

20" DEEP	PRICE	LINER WIDTH	CFM	LINER INFO <i>See Page 400-9</i>
<b>24" HIGH</b>				
WHBXA3024	2898	28-3/8"	300	A
WHBXA3624	2960	34-3/8"	600	D
WHBXA4224	3972	40-3/8"	600	E
WHBXA4824	4365	46-3/8"	600	F
<b>30" HIGH</b>				
WHBXA3030	2968	28-3/8"	300	A
WHBXA3630	3037	34-3/8"	600	D
WHBXA4230	4058	40-3/8"	600	E
WHBXA4830	4458	46-3/8"	600	F
<b>33" HIGH</b>				
WHBXA3033	3002	28-3/8"	300	A
WHBXA3633	3076	34-3/8"	600	D
WHBXA4233	4100	40-3/8"	600	E
WHBXA4833	4504	46-3/8"	600	F
<b>36" HIGH</b>				
WHBXA3036	3037	28-3/8"	300	A
WHBXA3636	3114	34-3/8"	600	D
WHBXA4236	4142	40-3/8"	600	E
WHBXA4836	4551	46-3/8"	600	F
<b>42" HIGH</b>				
WHBXA3042	3106	28-3/8"	300	A
WHBXA3642	3191	34-3/8"	600	D
WHBXA4242	4227	40-3/8"	600	E
WHBXA4842	4644	46-3/8"	600	F

24" DEEP	PRICE	LINER WIDTH	CFM	LINER INFO <i>See Page 400-9</i>
<b>30" HIGH</b>				
WHBXA3030-24	3707	28-3/8"	600	G
WHBXA3630-24	3778	34-3/8"	600	H
WHBXA4230-24	4131	40-3/8"	600	I
WHBXA4830-24	5262	46-3/8"	900	J
WHBXA5430-24	6874	52-3/8"	1200	K
WHBXA6030-24	7805	58-3/8"	1200	L
<b>36" HIGH</b>				
WHBXA3036-24	3780	28-3/8"	600	G
WHBXA3636-24	3860	34-3/8"	600	H
WHBXA4236-24	4221	40-3/8"	600	I
WHBXA4836-24	5360	46-3/8"	900	J
WHBXA5436-24	6979	52-3/8"	1200	K
WHBXA6036-24	7918	58-3/8"	1200	L
<b>42" HIGH</b>				
WHBXA3042-24	3855	28-3/8"	600	G
WHBXA3642-24	3942	34-3/8"	600	H
WHBXA4242-24	4311	40-3/8"	600	I
WHBXA4842-24	5458	46-3/8"	900	J
WHBXA5442-24	7086	52-3/8"	1200	K
WHBXA6042-24	8033	58-3/8"	1200	L

## WOOD HOOD BOX ARCH STYLE WITH PANELS (WHBXAP)

## WOOD HOOD BOX ARCH STYLE WITH CORBELS (WHBXAC)

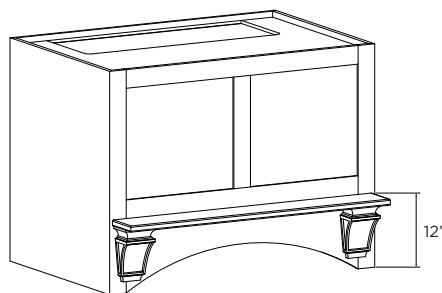
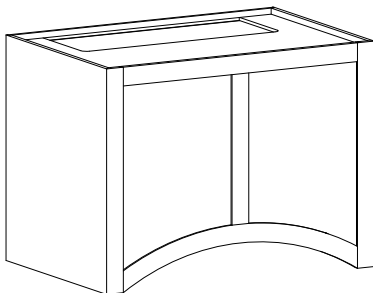

For Panels or Corbels specify the appropriate code and add to the base price.

WHBXAP (Panels) .....Add \$470

WHBXAC (Corbels) .....Add \$1,651

# ELAN WOOD HOODS

## WOOD HOOD WITH FLARED CANOPY (WHF)

- Hoods are available in standard wood species only.
- Vent-A-Hood liner and blower is included and shipped loose. See liner/blower chart on page 400-9 for detailed specs.
- Modifications are limited. Call for availability and quote.
- Dealer is responsible for compliance with local building codes (ventilation, installation, clearances and liner width). As a guideline, hoods are recommended for installation 30" above cooking surface, and liner width should be same width or wider than cooking surface.

24" DEEP	PRICE	LINER WIDTH	CFM	LINER INFO <i>See Page 400-9</i>
<b>30" HIGH</b>				
WHF3630-24	4948	34-3/8"	600	H
WHF4230-24	5276	40-3/8"	600	I
WHF4830-24	6382	46-3/8"	900	J
WHF5430-24	7969	52-3/8"	1200	K
WHF6030-24	8875	58-3/8"	1200	L
<b>36" HIGH</b>				
WHF3636-24	4972	34-3/8"	600	H
WHF4236-24	5304	40-3/8"	600	I
WHF4836-24	6415	46-3/8"	900	J
WHF5436-24	8005	52-3/8"	1200	K
WHF6036-24	8915	58-3/8"	1200	L
<b>42" HIGH</b>				
WHF3642-24	4995	34-3/8"	600	H
WHF4242-24	5332	40-3/8"	600	I
WHF4842-24	6447	46-3/8"	900	J
WHF5442-24	8042	52-3/8"	1200	K
WHF6042-24	8957	58-3/8"	1200	L
<b>48" HIGH</b>				
WHF3648-24	5019	34-3/8"	600	H
WHF4248-24	5360	40-3/8"	600	I
WHF4848-24	6480	46-3/8"	900	J
WHF5448-24	8079	52-3/8"	1200	K
WHF6048-24	8998	58-3/8"	1200	L
<b>54" HIGH</b>				
WHF3654-24	5043	34-3/8"	600	H
WHF4254-24	5389	40-3/8"	600	I
WHF4854-24	6512	46-3/8"	900	J
WHF5454-24	8115	52-3/8"	1200	K
WHF6054-24	9038	58-3/8"	1200	L

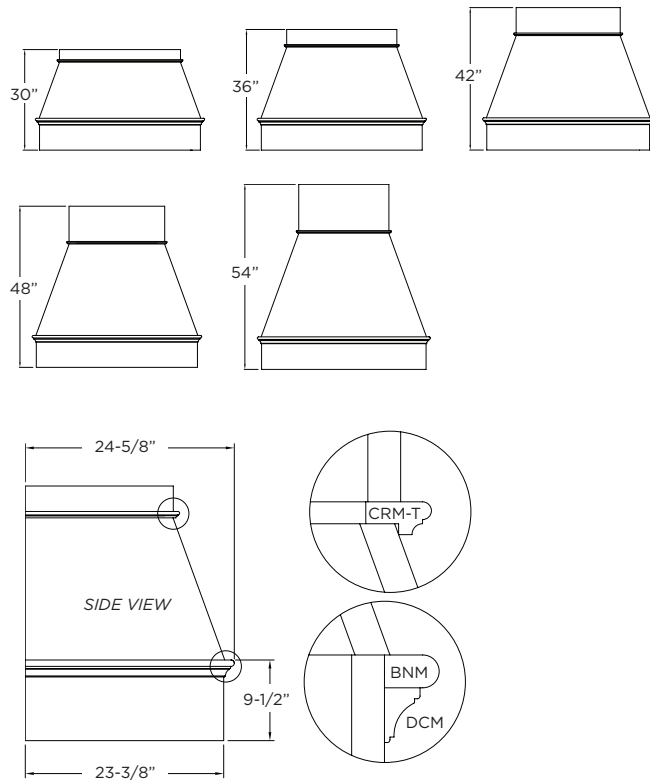
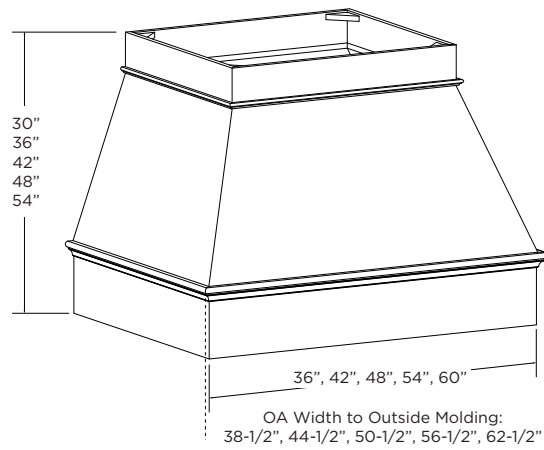

## WOOD HOOD WITH PANELS (WHFP)

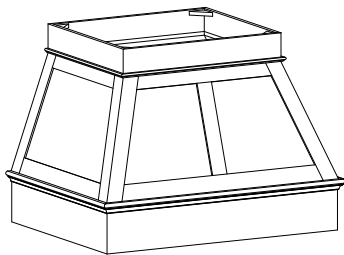

## WOOD HOOD WITH SHIPLAP (WHFS)

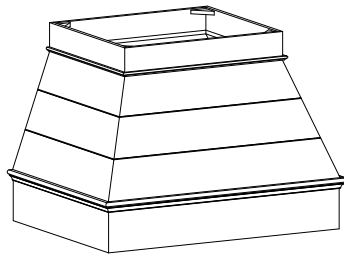

For Panels or Shiplap, specify the appropriate code and add to the base price.

WHFP (Panels).....Add \$779

WHFS (Shiplap).....Add \$231

Specify Straight or Mission Valance .....N/C

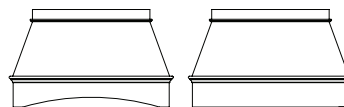

### VALANCE STYLES

Straight Mission



## WOOD HOOD WITH CURVED CANOPY (WHC)

- Hoods are available in standard wood species only.
- Vent-A-Hood liner and blower is included and shipped loose. See liner/blower chart on page 400-9 for detailed specs.
- Modifications are limited. Call for availability and quote.
- Dealer is responsible for compliance with local building codes (ventilation, installation, clearances and liner width). As a guideline, hoods are recommended for installation 30" above cooking surface, and liner width should be same width or wider than cooking surface.

24" DEEP	PRICE	LINER WIDTH	CFM	LINER INFO <i>See Page 400-9</i>
<b>30" HIGH</b>				
WHC3630-24	6281	28-3/8"	600	G
WHC4230-24	6707	34-3/8"	600	H
WHC4830-24	7911	40-3/8"	600	I
WHC5430-24	9494	46-3/8"	900	J
WHC6030-24	10598	52-3/8"	1200	K
<b>36" HIGH</b>				
WHC3636-24	6563	28-3/8"	600	G
WHC4236-24	7003	34-3/8"	600	H
WHC4836-24	8222	40-3/8"	600	I
WHC5436-24	9921	46-3/8"	900	J
WHC6036-24	10940	52-3/8"	1200	K
<b>42" HIGH</b>				
WHC3642-24	6844	28-3/8"	600	G
WHC4242-24	7300	34-3/8"	600	H
WHC4842-24	8534	40-3/8"	600	I
WHC5442-24	10249	46-3/8"	900	J
WHC6042-24	11283	52-3/8"	1200	K
<b>48" HIGH</b>				
WHC3648-24	7126	28-3/8"	600	G
WHC4248-24	7597	34-3/8"	600	H
WHC4848-24	8847	40-3/8"	600	I
WHC5448-24	10576	46-3/8"	900	J
WHC6048-24	11625	52-3/8"	1200	K

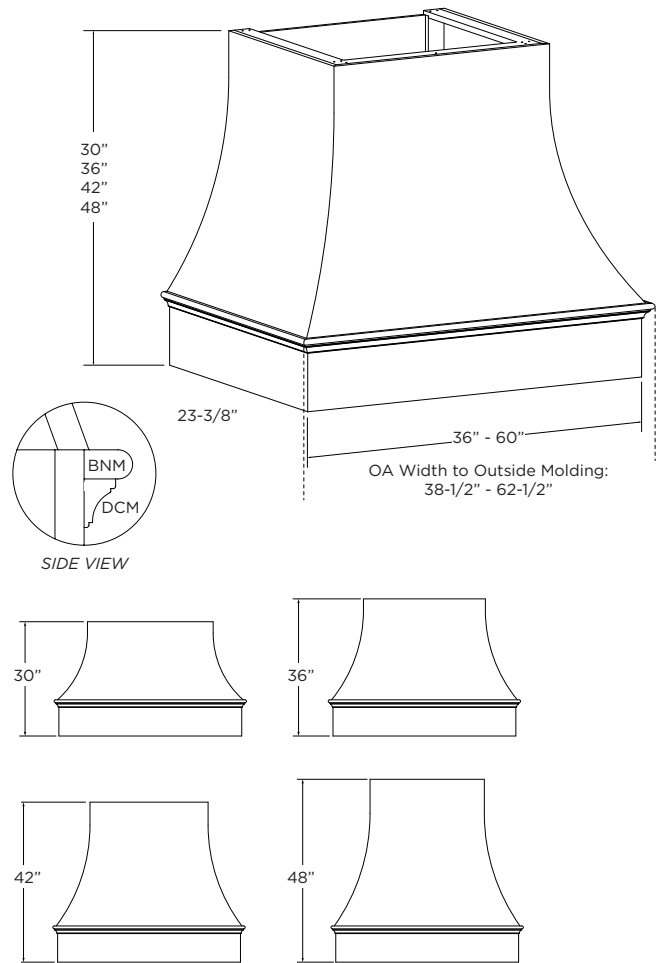

Specify Straight or Mission Valance .....N/C

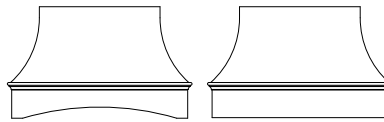

### VALANCE STYLES

Straight

Mission

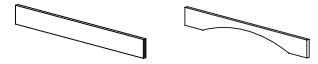

# ELAN WOOD HOODS

## WOOD HOODS

- Hoods are available in standard wood species only.
- Vent-A-Hood liner and blower is included and shipped loose. See liner/blower chart on page 400-9 for detailed specs.
- Modifications are limited. Call for availability and quote.
- Dealer is responsible for compliance with local building codes (ventilation, installation, clearances and liner width). As a guideline, hoods are recommended for installation 30" above cooking surface, and liner width should be same width or wider than cooking surface.

### STYLE A

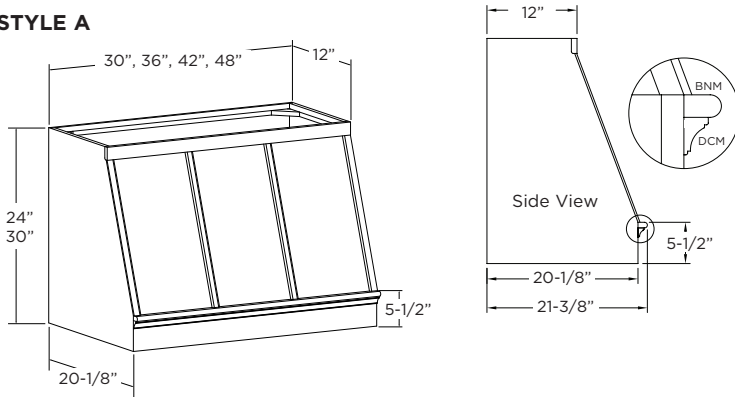

STYLE A	PRICE	LINER WIDTH	CFM	LINER INFO <i>See Page 400-9</i>
<b>24" HIGH</b>				
WHA3024	3287	28-3/8"	300	A
WHA3624	4026	34-3/8"	300	B
WHA4224	4392	40-3/8"	300	C
WHA4824	4800	46-3/8"	600	F
<b>30" HIGH</b>				
WHA3030	3339	28-3/8"	300	A
WHA3630	4086	34-3/8"	300	B
WHA4230	4451	40-3/8"	300	C
WHA4830	4863	46-3/8"	600	F

### STYLE AA

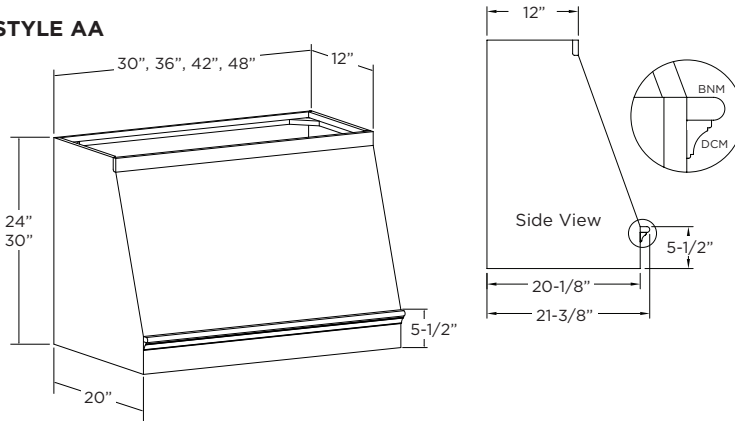

STYLE AA	PRICE	LINER WIDTH	CFM	LINER INFO <i>See Page 400-9</i>
<b>24" HIGH</b>				
WHAA3024	3150	28-3/8"	300	A
WHAA3624	3889	34-3/8"	300	B
WHAA4224	4255	40-3/8"	300	C
WHAA4824	4663	46-3/8"	600	F
<b>30" HIGH</b>				
WHAA3030	3202	28-3/8"	300	A
WHAA3630	3945	34-3/8"	300	B
WHAA4230	4314	40-3/8"	300	C
WHAA4830	4726	46-3/8"	600	F

### STYLE O

- Non-Functional Doors on Top

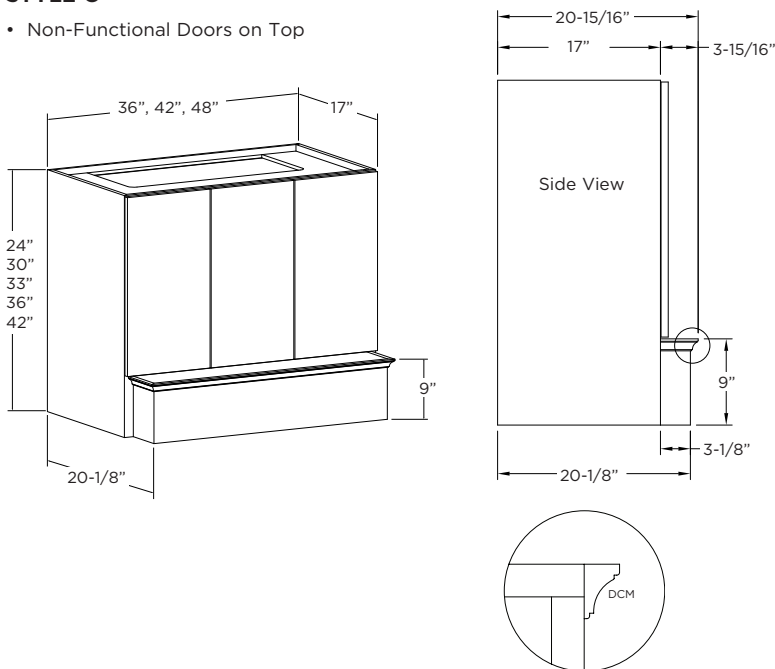

STYLE O	PRICE	LINER WIDTH	CFM	LINER INFO <i>See Page 400-9</i>
<b>24" HIGH</b>				
WHO3624E	3720	28-3/8"	300	A
WHO4224E	4081	34-3/8"	300	B
WHO4824E	5196	40-3/8"	300	C
<b>30" HIGH</b>				
WHO3630E	3858	34-3/8"	300	A
WHO4230E	4232	40-3/8"	300	B
WHO4830E	5359	46-3/8"	300	C
<b>33" HIGH</b>				
WHO3633E	3927	34-3/8"	300	A
WHO4233E	4307	40-3/8"	300	B
WHO4833E	5441	46-3/8"	300	C
<b>36" HIGH</b>				
WHO3636E	3995	34-3/8"	300	A
WHO4236E	4382	40-3/8"	300	B
WHO4836E	5523	46-3/8"	300	C
<b>42" HIGH</b>				
WHO3642E	4133	34-3/8"	300	A
WHO4242E	4533	40-3/8"	300	B
WHO4842E	5686	46-3/8"	300	C

## WOOD HOOD MODERN (WHM)

- Hoods are available in standard wood species only.
- Vent-A-Hood liner and blower is included and shipped loose. See liner/blower chart on page 400-9 for detailed specs.
- Modifications are limited. Call for availability and quote.
- Dealer is responsible for compliance with local building codes (ventilation, installation, clearances and liner width). As a guideline, hoods are recommended for installation 30" above cooking surface, and liner width should be same width or wider than cooking surface.

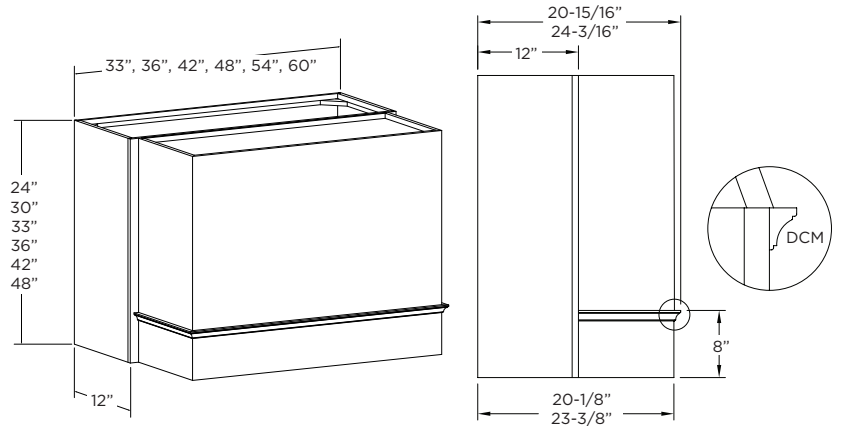

20" DEEP	PRICE	LINER WIDTH	CFM	LINER INFO <i>See Page 400-9</i>
<b>24" HIGH</b>				
WHM3324	3355	28-3/8"	300	A
WHM3624	3389	28-3/8"	300	A
WHM4224	4191	34-3/8"	600	D
WHM4824	4557	40-3/8"	600	E
<b>30" HIGH</b>				
WHM3330	3478	28-3/8"	300	A
WHM3630	3520	28-3/8"	300	A
WHM4230	4339	34-3/8"	600	D
WHM4830	4722	40-3/8"	600	E
<b>33" HIGH</b>				
WHM3333	3539	28-3/8"	300	A
WHM3633	3585	28-3/8"	300	A
WHM4233	4413	34-3/8"	600	D
WHM4833	4805	40-3/8"	600	E
<b>36" HIGH</b>				
WHM3336	3600	28-3/8"	300	A
WHM3636	3651	28-3/8"	300	A
WHM4236	4487	34-3/8"	600	D
WHM4836	4887	40-3/8"	600	E
<b>42" HIGH</b>				
WHM3342	3722	28-3/8"	300	A
WHM3642	3782	28-3/8"	300	A
WHM4242	4635	34-3/8"	600	D
WHM4842	5052	40-3/8"	600	E

24" DEEP	PRICE	LINER WIDTH	CFM	LINER INFO <i>See Page 400-9</i>
<b>30" HIGH</b>				
WHM3630-24	4261	28-3/8"	600	G
WHM4230-24	4418	34-3/8"	600	H
WHM4830-24	4794	40-3/8"	600	I
WHM5430-24	5949	46-3/8"	900	J
WHM6030-24	7584	52-3/8"	1200	K
<b>36" HIGH</b>				
WHM3636-24	4397	28-3/8"	600	G
WHM4236-24	4571	34-3/8"	600	H
WHM4836-24	4964	40-3/8"	600	I
WHM5436-24	6136	46-3/8"	900	J
WHM6036-24	7788	52-3/8"	1200	K
<b>42" HIGH</b>				
WHM3642-24	4533	28-3/8"	600	G
WHM4242-24	4724	34-3/8"	600	H
WHM4842-24	5135	40-3/8"	600	I
WHM5442-24	6324	46-3/8"	900	J
WHM6042-24	7993	52-3/8"	1200	K
<b>48" HIGH</b>				
WHM3648-24	4669	28-3/8"	600	G
WHM4248-24	4877	34-3/8"	600	H
WHM4848-24	5306	40-3/8"	600	I
WHM5448-24	6512	46-3/8"	900	J
WHM6048-24	8197	52-3/8"	1200	K

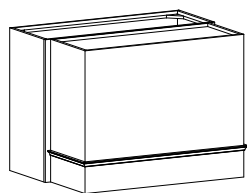

WHMA .....Add \$0

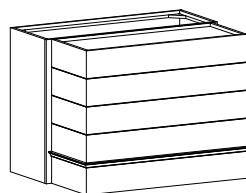

WHMB .....Add \$600

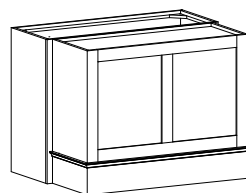

WHMC ..... Add \$730

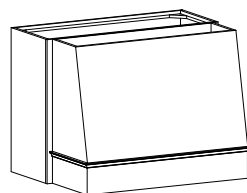

WHMD .....Add \$1,015

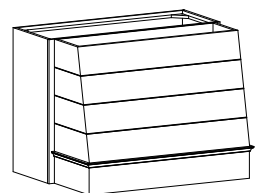

WHME.....Add \$1,620

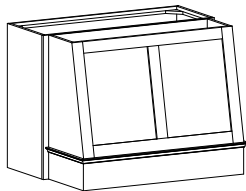

WHMF..... Add \$1,745

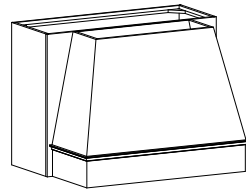

WHMG .....Add \$1,015

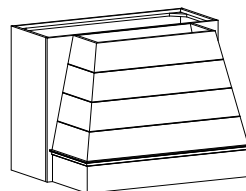

WHMH .....Add \$1,620

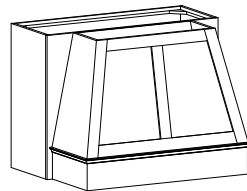

WHMI..... Add \$1,745

- Specify Canopy Style, A - I, with appropriate canopy upcharge if applicable.
- Specify Straight or Mission Valance .....N/C

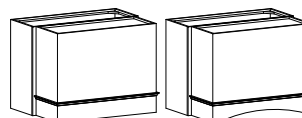

### VALANCE STYLES

Straight

Mission



# ELAN WOOD HOODS

## WOOD HOOD INDEPENDENT MODERN (WHIM)

- Hoods are available in standard wood species only.
- Vent-A-Hood liner and blower is included and shipped loose. See liner/blower chart on page 400-9 for detailed specs.
- Modifications are limited. Call for availability and quote.
- Dealer is responsible for compliance with local building codes (ventilation, installation, clearances and liner width). As a guideline, hoods are recommended for installation 30" above cooking surface, and liner width should be same width or wider than cooking surface.

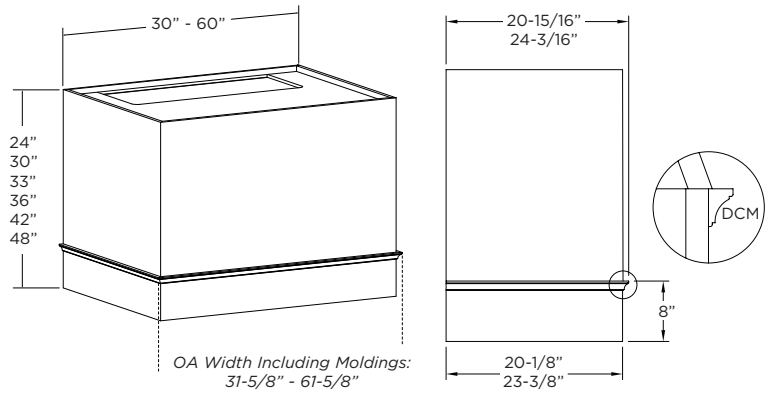

20" DEEP	PRICE	LINER WIDTH	CFM	LINER INFO <i>See Page 400-9</i>
<b>24" HIGH</b>				
WHIM3024	3019	28-3/8"	300	A
WHIM3624	3719	34-3/8"	600	D
WHIM4224	4060	40-3/8"	600	E
WHIM4824	4440	46-3/8"	600	F
<b>30" HIGH</b>				
WHIM3030	3088	28-3/8"	300	A
WHIM3630	3796	34-3/8"	600	D
WHIM4230	4144	40-3/8"	600	E
WHIM4830	4533	46-3/8"	600	F
<b>33" HIGH</b>				
WHIM3033	3123	28-3/8"	300	A
WHIM3633	3834	34-3/8"	600	D
WHIM4233	4187	40-3/8"	600	E
WHIM4833	4579	46-3/8"	600	F
<b>36" HIGH</b>				
WHIM3036	3158	28-3/8"	300	A
WHIM3636	3873	34-3/8"	600	D
WHIM4236	4299	40-3/8"	600	E
WHIM4836	4626	46-3/8"	600	F
<b>42" HIGH</b>				
WHIM3042	3227	28-3/8"	300	A
WHIM3642	3950	34-3/8"	600	D
WHIM4242	4314	40-3/8"	600	E
WHIM4842	4718	46-3/8"	600	F

24" DEEP	PRICE	LINER WIDTH	CFM	LINER INFO <i>See Page 400-9</i>
<b>30" HIGH</b>				
WHIM3630-24	3882	34-3/8"	600	H
WHIM4230-24	4227	40-3/8"	600	I
WHIM4830-24	5319	46-3/8"	900	J
WHIM5430-24	6873	52-3/8"	1200	K
WHIM6030-24	7771	58-3/8"	1200	L
<b>36" HIGH</b>				
WHIM3636-24	3964	34-3/8"	600	H
WHIM4236-24	4317	40-3/8"	600	I
WHIM4836-24	5416	46-3/8"	900	J
WHIM5436-24	6978	52-3/8"	1200	K
WHIM6036-24	7885	58-3/8"	1200	L
<b>42" HIGH</b>				
WHIM3642-24	4046	34-3/8"	600	H
WHIM4242-24	4406	40-3/8"	600	I
WHIM4842-24	5514	46-3/8"	900	J
WHIM5442-24	7084	52-3/8"	1200	K
WHIM6042-24	7999	58-3/8"	1200	L
<b>48" HIGH</b>				
WHIM3648-24	4128	34-3/8"	600	H
WHIM4248-24	4496	40-3/8"	600	I
WHIM4848-24	5613	46-3/8"	900	J
WHIM5448-24	7190	52-3/8"	1200	K
WHIM6048-24	8112	58-3/8"	1200	L

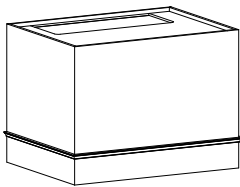

WHIMA .....Add \$0

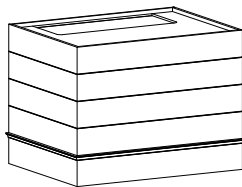

WHIMB ..... Add \$620

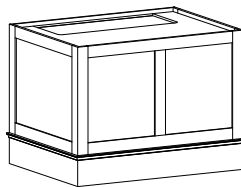

WHIMC ... Add \$1,050

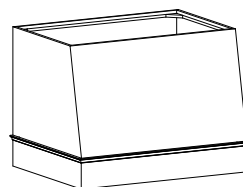

WHIMD .... Add \$1,570

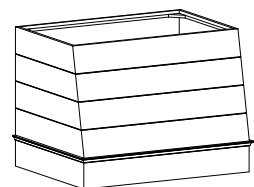

WHIME ....Add \$2,180

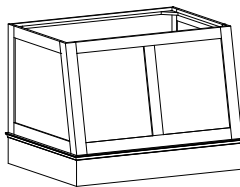

WHIMF ...Add \$2,690

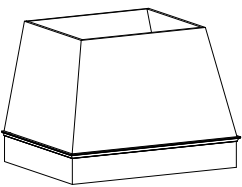

WHIMG .... Add \$1,570

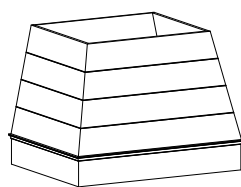

WHIMH .... Add \$2,180

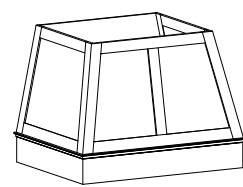

WHIMI..... Add \$2,690

- Specify Canopy Style, A - I, with appropriate canopy upcharge if applicable.
- Specify Straight or Mission Valance .....N/C

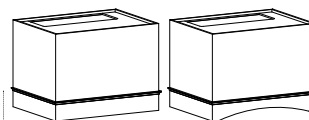

### VALANCE STYLES

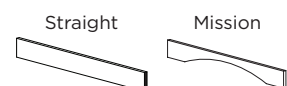

## LINER INFORMATION/REFERENCE PAGE

**BHSLD**

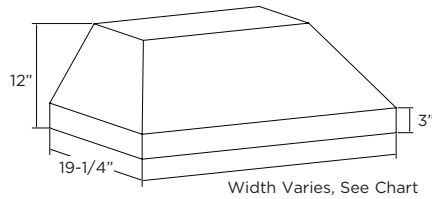

**BHPSLD**

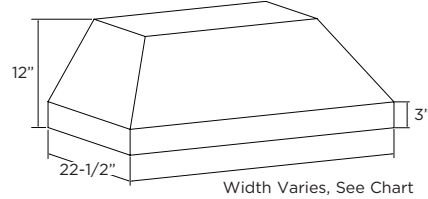

LINER/BLOWER REFERENCE #	LINER CODE	CFM	WIDTH	DEPTH	OMIT LINER/BLOWER CREDIT
A	BH128SLD	300	28-3/8"	19-1/4"	1,649
B	BH134SLD	300	34-3/8"	19-1/4"	1,649
C	BH140SLD	300	40-3/8"	19-1/4"	1,852
D*	BH234SLD	300/600	34-3/8"	19-1/4"	2,158
E*	BH240SLD	300/600	40-3/8"	19-1/4"	2,380
F	BH246SLD	300/600	46-3/8"	19-1/4"	2,635
G*	BH228PSLD	300/600	28-3/8"	22-1/2"	2,191
H*	BH234PSLD	300/600	34-3/8"	22-1/2"	2,191
I*	BH240PSLD	300/600	40-3/8"	22-1/2"	2,408
J*	BH346PSLD	300/600/900	46-3/8"	22-1/2"	3,224
K*	BH452PSLD	300/600/900/1200	52-3/8"	22-1/2"	4,408
L	BH458PSLD	300/600/900/1200	58-3/8"	22-1/2"	5,070

\* 300 CFM blower is available for units D, E, G, H, I, J, K for No Charge/No Credit. Specify 300CFM after the code.

- Liner and Blower can be omitted and credit applied. Specify "omit liner/blower".
- Hoods are designed and sized for use with a specific Vent-A-Hood Liner/Blower. The Liner is stainless steel with LED lights. The liner/blower is included in the price of the hood and shipped loose for jobsite installation.
- Dealers are responsible for verifying compliance with local building codes (ventilation requirements, installation and clearances). Refer to appliance specifications for required mounting height. A liner should never be narrower than the appliance it covers. Depth of liner should fully cover all burners.
- Vent-A-Hood Liners are shipped complete with an inner canopy, LED lights, blowers, and switches and are pre-wired, pre-assembled and ready to install.
- The standard ventilation of the BHSLD model is intended for use over standard cooking equipment. (See Liners A-F in chart.) The extra size and blower capacity of the BHPSLD model can be used above professional-style cooking equipment (See Liners H-L in chart.)
- 300 CFM units are a single blower system (B100). 300/600 CFM units are a dual blower system (B200). 300/600/900 CFM units include a single blower (B100) and a dual speed blower (B200). (Dual blower is on the left.) 300/600/900/1200 CFM units include two, dual blowers (2-B200).
- For more information, refer to the Vent-A-Hood website. [www.ventahood.com](http://www.ventahood.com)
- Consult with a qualified HVAC professional to determine if air-makeup is required with the blower unit specified







**TABLE OF CONTENTS**

**ELAN BASE CABINETS..... E500-1 thru E500-9**

Standard Base Cabinets.....E500-2  
Base with Full Height Doors.....E500-2  
Base with Roll Trays.....E500-3  
Base 2 Drawer.....E500-4  
Base 2 Drawer with Hidden Drawer.....E500-4  
Base 2 Drawer with Peg Board Drawer Organizer .....E500-4  
2-Drawer With Drawer Divider Inserts.....E500-5  
3 Drawer Base.....E500-6  
4 Drawer Base.....E500-6  
Sink Front.....E500-6  
Base Sink Cabinets with Full Height Door(s).....E500-7  
Base Sink Reverse .....E500-7  
Base Sink Cabinet with False Drawer Front .....E500-8  
Drop Front Sink Base.....E500-8



# ELAN BASE CABINETS

## STANDARD BASE

### SINGLE DOOR

- Specify Hinge (L or R)
- 9"W - 24-1"W

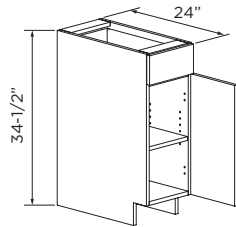

### BUTT DOORS

24-2"W - 36"W

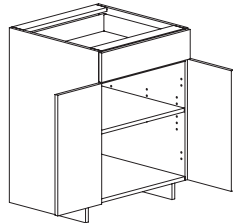

### DOUBLE DOOR

39"W - 48-2"W

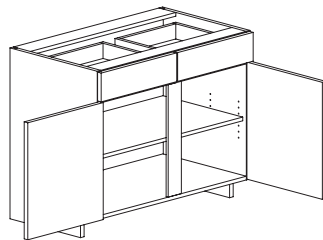

34-1/2" HIGH	A	B	C	D	E	F	G
1 Adjustable Shelf, 1 Drawer							
EB9	678	713	747	781	835	869	910
EB12	715	751	787	823	880	916	958
EB15	764	802	841	879	940	978	1024
EB18	809	850	891	932	996	1037	1086
EB21	862	905	949	991	1061	1104	1155
EB24-1	906	951	998	1043	1115	1160	1214
EB24-2	1023	1075	1126	1177	1259	1311	1372
EB27	1076	1130	1183	1237	1324	1378	1443
EB30	1122	1178	1235	1291	1381	1438	1505
EB33	1170	1229	1287	1346	1440	1498	1568
EB36	1214	1275	1336	1396	1494	1555	1627
1 Adjustable Shelf, 2 Drawer							
EB39	1357	1424	1493	1561	1670	1737	1819
EB42	1406	1476	1546	1617	1730	1800	1884
EB45	1463	1537	1610	1683	1801	1874	1961
EB48-2	1510	1586	1661	1737	1858	1933	2023

## BASE WITH FULL HEIGHT DOORS

- No Drawers

### SINGLE DOOR

- Specify Hinge (L or R)
- 9"W - 24-1"W

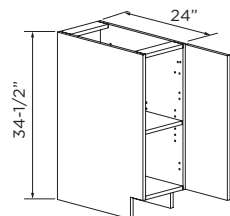

### BUTT DOORS

24-2"W - 36"W

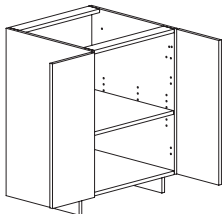

### DOUBLE DOOR

39"W - 48-2"W

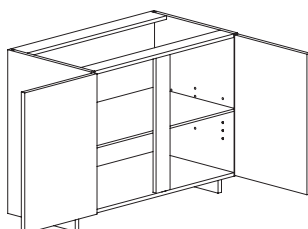

34-1/2" HIGH	A	B	C	D	E	F	G
1 Adjustable Shelf							
EB9FHD	538	565	592	619	663	689	721
EB12FHD	586	615	644	674	721	751	773
EB15FHD	634	666	698	730	781	813	851
EB18FHD	680	714	748	782	836	870	912
EB21FHD	731	768	804	841	900	936	980
EB24FHD-1	775	814	853	892	954	993	1039
EB24FHD-2	897	943	988	1033	1104	1149	1203
EB27FHD	949	996	1044	1092	1167	1215	1271
EB30FHD	999	1049	1099	1149	1229	1279	1339
EB33FHD	1045	1098	1150	1203	1286	1339	1401
EB36FHD	1089	1144	1199	1253	1340	1395	1460
EB39FHD	1109	1164	1220	1276	1364	1419	1487
EB42FHD	1154	1211	1270	1328	1421	1478	1546
EB45FHD	1185	1243	1303	1363	1457	1517	1588
EB48FHD-2	1213	1274	1335	1395	1493	1553	1626

# ELAN BASE CABINETS

## BASE WITH 1 ROLL TRAY

- Roll Trays are 3" high, dovetailed with undermount, full extension, soft-close glides.

### SINGLE DOOR

- Specify Hinge (L or R)
- 15-1"W - 24-1-1"W

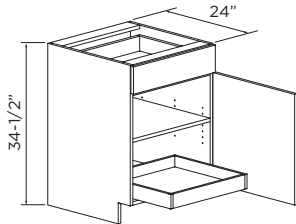

### BUTT DOORS

24-1-2"W - 36-1"W

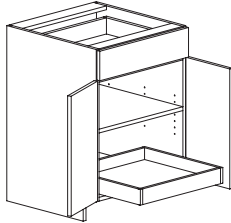

### DOUBLE DOORS

39-2"W - 48-2-2"W

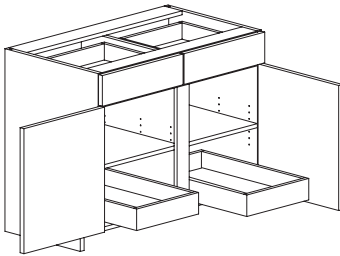

34-1/2" HIGH	A	B	C	D	E	F	G
1 Adjustable Shelf, 1 Drawer, 1 Roll Tray							
EB12RT-1	928	973	1017	1061	1132	1176	1228
EB15RT-1	968	1015	1061	1106	1180	1226	1281
EB18RT-1	1011	1059	1108	1156	1234	1281	1339
EB21RT-1	1060	1110	1161	1213	1293	1344	1405
EB24RT-1-1	1100	1153	1205	1258	1342	1395	1458
EB24RT-1-2	1215	1274	1333	1391	1484	1543	1612
EB27RT-1	1320	1384	1447	1511	1614	1677	1753
EB30RT-1	1364	1430	1496	1562	1667	1734	1812
EB33RT-1	1408	1477	1545	1612	1721	1790	1872
EB36RT-1	1451	1521	1592	1663	1774	1845	1928
2 Adjustable Shelves, 2 Drawers, 2 Roll Trays							
EB39RT-2	1774	1858	1943	2026	2160	2243	2345
EB42RT-2	1823	1910	1996	2082	2220	2307	2410
EB45RT-2	1880	1969	2059	2148	2291	2380	2487
EB48RT-2-2	1927	2018	2110	2202	2348	2439	2549

## BASE WITH 2 ROLL TRAYS

- Roll Trays are 3" high, dovetailed with undermount, full extension, soft-close glides.

### SINGLE DOOR

- Specify Hinge (L or R)
- 15-2"W - 24-2-1"W

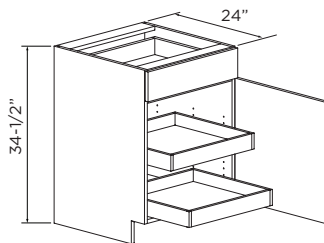

### BUTT DOORS

24-2-2"W - 36-2"W

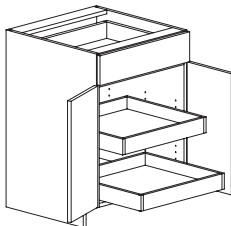

### DOUBLE DOOR

39-4"W - 48-4-2"W

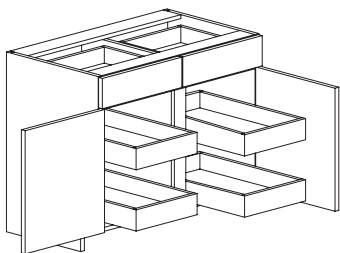

34-1/2" HIGH	A	B	C	D	E	F	G
1 Drawer, 2 Roll Trays							
EB12RT-2	1115	1165	1218	1269	1351	1402	1463
EB15RT-2	1153	1205	1259	1312	1396	1449	1512
EB18RT-2	1191	1246	1301	1356	1443	1498	1562
EB21RT-2	1241	1298	1356	1413	1505	1561	1630
EB24RT-2-1	1282	1341	1401	1461	1555	1615	1686
EB24RT-2-2	1394	1458	1523	1588	1692	1757	1835
EB27RT-2	1554	1627	1700	1773	1889	1962	2049
EB30RT-2	1598	1672	1748	1824	1944	2018	2109
EB33RT-2	1643	1720	1798	1875	1999	2076	2169
EB36RT-2	1682	1762	1841	1921	2048	2126	2221
2 Drawers, 4 Roll Trays							
EB39RT-4	2137	2234	2331	2429	2584	2681	2797
EB42RT-4	2187	2286	2386	2487	2645	2746	2864
EB45RT-4	2243	2346	2449	2551	2715	2817	2940
EB48RT-4-2	2290	2395	2500	2604	2771	2877	3002

# ELAN BASE CABINETS

## BASE 2 DRAWER

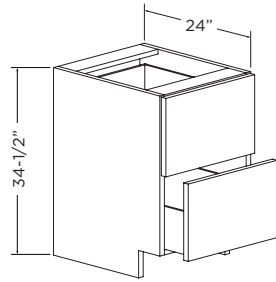

ITEM	A	B	C	D	E	F	G
EB2D12	1048	1100	1153	1205	1290	1341	1405
EB2D15	1090	1145	1200	1254	1342	1396	1462
EB2D18	1203	1263	1324	1384	1480	1540	1612
EB2D21	1282	1346	1411	1476	1578	1642	1719
EB2D24	1357	1424	1493	1561	1670	1737	1819
EB2D27	1394	1463	1533	1603	1715	1785	1868
EB2D30	1468	1542	1616	1689	1807	1880	1968
EB2D33	1548	1625	1703	1780	1905	1982	2075
EB2D36	1622	1703	1785	1867	1996	2077	2175
EB2D39	1700	1785	1870	1956	2092	2177	2279
EB2D42	1781	1870	1960	2052	2192	2282	2389

## BASE 2 DRAWER WITH HIDDEN DRAWER

- 4" Hidden Drawer Above the Top Drawer

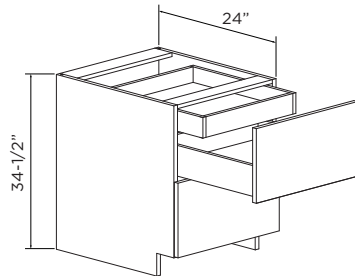

ITEM	A	B	C	D	E	F	G
EB2D15HD	1215	1276	1337	1399	1495	1556	1628
EB2D18HD	1438	1510	1582	1654	1769	1841	1927
EB2D21HD	1345	1412	1479	1546	1654	1721	1802
EB2D24HD	1452	1524	1598	1671	1787	1859	1946
EB2D27HD	1490	1565	1639	1714	1834	1908	1998
EB2D30HD	1540	1617	1694	1771	1895	1972	2065
EB2D33HD	1622	1703	1785	1867	1996	2077	2175
EB2D36HD	1672	1756	1840	1924	2057	2142	2242
EB2D39HD	1724	1810	1897	1986	2122	2209	2312
EB2D42HD	1778	1867	1956	2046	2188	2277	2384

## BASE 2 DRAWER WITH HIDDEN DRAWER - STYLE A

- 4" Hidden Drawer Above the Top Drawer with a Cutlery Divider
- Peg Board Drawer Organizer in Top Deep Drawer

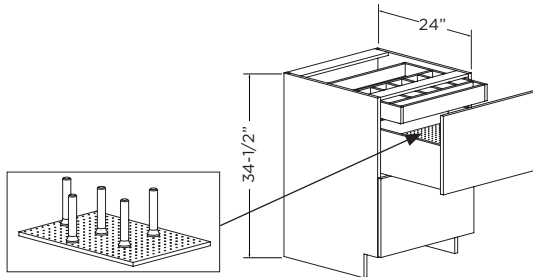

ITEM	A	B	C	D	E	F	G
EB2D15HD-A	1601	1681	1762	1842	1971	2050	2147
EB2D18HD-A	1656	1740	1823	1906	2038	2121	2220
EB2D21HD-A	1725	1812	1899	1984	2122	2209	2312
EB2D24HD-A	1774	1863	1952	2040	2182	2271	2378
EB2D27HD-A	1944	2040	2138	2236	2391	2489	2605
EB2D30HD-A	2011	2111	2213	2313	2474	2575	2696
EB2D33HD-A	2067	2171	2275	2378	2543	2647	2770
EB2D36HD-A	2132	2238	2346	2452	2623	2730	2857
EB2D39HD-A	2198	2307	2418	2529	2704	2815	2944
EB2D42HD-A	2266	2379	2493	2607	2788	2902	3038

## 2-DRAWER WITH PEG BOARD DRAWER ORGANIZER

- Organizer in Top Drawer

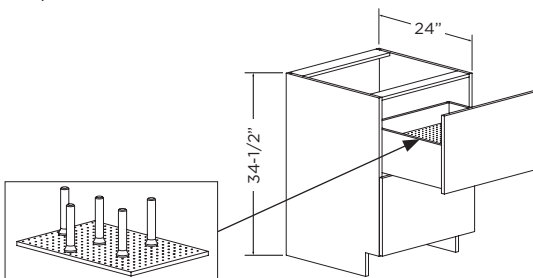

ITEM	A	B	C	D	E	F	G
EB2D15PBDO	1240	1302	1364	1427	1526	1587	1661
EB2D18PBDO	1295	1359	1424	1489	1593	1658	1736
EB2D21PBDO	1346	1413	1482	1549	1656	1724	1804
EB2D24PBDO	1480	1555	1630	1703	1822	1896	1984
EB2D27PBDO	1532	1609	1686	1762	1885	1961	2054
EB2D30PBDO	1612	1693	1774	1855	1984	2065	2161
EB2D33PBDO	1665	1748	1833	1916	2049	2132	2232
EB2D36PBDO	1721	1807	1894	1980	2117	2204	2307
EB2D39PBDO	1779	1868	1960	2048	2190	2279	2386
EB2D42PBDO	1840	1932	2025	2117	2262	2357	2467

# ELAN BASE CABINETS

## 2-DRAWER WITH DRAWER DIVIDER INSERTS

### STYLE A

- Dividers run front to back in bottom drawer
- Slots equally spaced

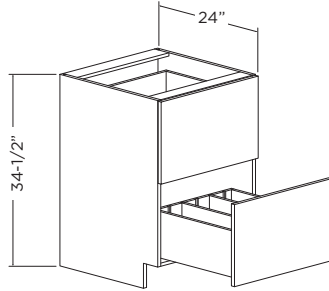

### STYLE B

- Dividers run side to side in bottom drawer
- Slots are equally spaced 2-3/4" apart

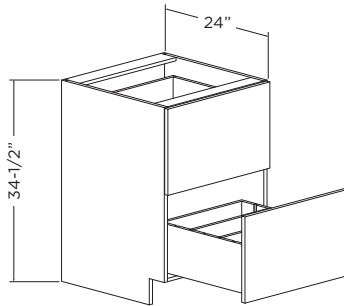

STYLE A	A	B	C	D	E	F	G
3 Slots, 3 Adjustable/Removable Dividers							
EB2D15DDI-A	1242	1304	1367	1429	1528	1590	1665
EB2D18DDI-A	1290	1355	1419	1484	1587	1652	1729
5 Slots, 3 Adjustable/Removable Dividers							
EB2D21DDI-A	1495	1570	1645	1720	1840	1914	2004
EB2D24DDI-A	1476	1549	1623	1698	1815	1889	1978
EB2D27DDI-A	1524	1600	1677	1754	1875	1952	2043
EB2D30DDI-A	1605	1686	1767	1846	1974	2055	2152
EB2D33DDI-A	1741	1828	1916	2002	2142	2229	2334
EB2D36DDI-A	1797	1886	1977	2067	2212	2301	2408
6 Slots, 3 Adjustable/Removable Dividers							
EB2D39DDI-A	1854	1946	2040	2131	2281	2375	2485
EB2D42DDI-A	1913	2009	2105	2201	2356	2451	2565

STYLE B	A	B	C	D	E	F	G
5 Slots, 2 Adjustable/Removable Dividers							
EB2D15DDI-B	1187	1247	1307	1366	1461	1520	1592
EB2D18DDI-B	1243	1306	1368	1430	1529	1592	1666
EB2D21DDI-B	1297	1362	1428	1493	1597	1661	1738
EB2D24DDI-B	1551	1628	1707	1785	1908	1987	2079
EB2D27DDI-B	1589	1669	1748	1828	1955	2034	2130
EB2D30DDI-B	1682	1767	1851	1935	2070	2154	2254
EB2D33DDI-B	1954	2051	2149	2247	2403	2501	2619
EB2D36DDI-B	1998	2098	2198	2298	2457	2557	2677
EB2D39DDI-B	2046	2146	2249	2352	2515	2618	2741
EB2D42DDI-B	2091	2196	2301	2406	2571	2676	2802

# ELAN BASE CABINETS

## 3 DRAWER BASE

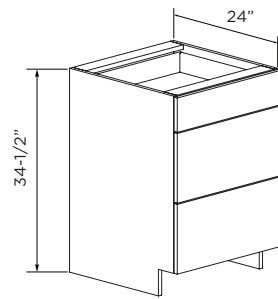

ITEM	A	B	C	D	E	F	G
EB3D12	1128	1185	1242	1298	1389	1445	1512
EB3D15	1166	1225	1284	1342	1435	1494	1564
EB3D18	1268	1331	1395	1458	1560	1623	1699
EB3D21	1341	1408	1476	1543	1650	1718	1797
EB3D24	1407	1478	1549	1619	1731	1802	1886
EB3D27	1479	1553	1627	1702	1820	1894	1983
EB3D30	1548	1625	1703	1780	1905	1982	2075
EB3D33	1621	1702	1784	1864	1994	2076	2172
EB3D36	1686	1770	1855	1939	2075	2159	2259
EB3D39	1753	1841	1929	2016	2157	2246	2349
EB3D42	1823	1914	2006	2098	2244	2336	2443

## 4 DRAWER BASE - STYLE A

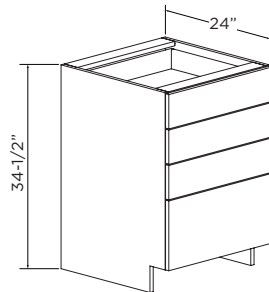

STYLE A	A	B	C	D	E	F	G
EB4D12A	1306	1370	1436	1502	1606	1672	1751
EB4D15A	1385	1455	1524	1593	1704	1774	1857
EB4D18A	1462	1535	1609	1682	1800	1872	1960
EB4D21A	1543	1620	1698	1775	1899	1976	2068
EB4D24A	1616	1697	1779	1859	1989	2070	2166
EB4D27A	1696	1780	1866	1951	2087	2171	2273
EB4D30A	1769	1857	1946	2035	2176	2265	2370
EB4D33A	1853	1946	2039	2132	2280	2373	2484
EB4D36A	1924	2021	2117	2214	2368	2463	2579
EB4D39A	2000	2100	2201	2301	2461	2562	2681
EB4D42A	2076	2182	2284	2389	2555	2657	2784

## 4 DRAWER BASE - STYLE B

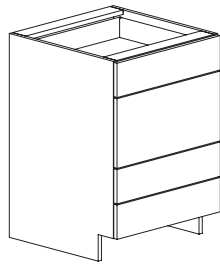

STYLE B	A	B	C	D	E	F	G
EB4D12B	1306	1370	1436	1502	1606	1672	1751
EB4D15B	1385	1455	1524	1593	1704	1774	1857
EB4D18B	1462	1535	1609	1682	1800	1872	1960
EB4D21B	1543	1620	1698	1775	1899	1976	2068
EB4D24B	1616	1697	1779	1859	1989	2070	2166
EB4D27B	1696	1780	1866	1951	2087	2171	2273
EB4D30B	1769	1857	1946	2035	2176	2265	2370
EB4D33B	1853	1946	2039	2132	2280	2373	2484
EB4D36B	1924	2021	2117	2214	2368	2463	2579
EB4D39B	2000	2100	2201	2301	2461	2562	2681
EB4D42B	2076	2182	2284	2389	2555	2657	2784

## SINK FRONT

- Includes Floor and Supports (Unattached)

### SINGLE DOOR

- Specify Hinge (L or R)
- 18"W - 24-1"W

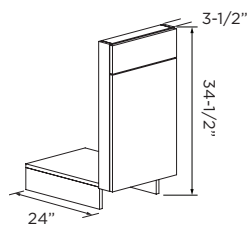

### BUTT DOORS

24-2"W - 36"W

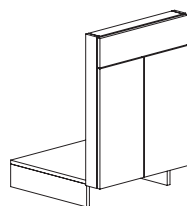

### DOUBLE DOOR

39"W - 48-2"W

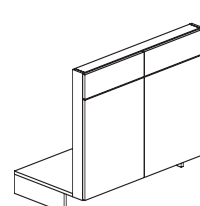

ITEM	A	B	C	D	E	F	G
ESF18	352	369	388	406	434	451	472
ESF21	377	395	414	434	463	483	505
ESF24-1	489	513	538	562	601	626	655
ESF24-2	521	546	573	599	641	667	698
ESF27	554	582	610	637	682	709	743
ESF30	703	738	774	809	866	900	943
ESF33	734	770	807	844	902	939	983
ESF36	767	804	844	883	944	982	1028
ESF39	795	835	874	914	978	1017	1065
ESF42	820	862	903	944	1010	1050	1100
ESF45	850	892	935	978	1045	1088	1139
ESF48-2	892	938	982	1027	1098	1143	1197

# ELAN BASE CABINETS

## BASE SINK CABINET WITH FULL HEIGHT DOOR(S)

- Has 6" Courtesy Apron Behind Door
- No Drawers, No Shelves

### SINGLE DOOR

- Specify Hinge (L or R)
- 15"W - 24-1"W

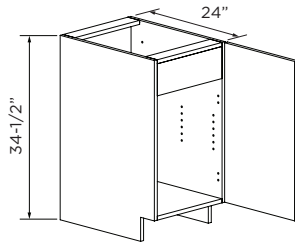

### BUTT DOORS

24-2"W - 36"W

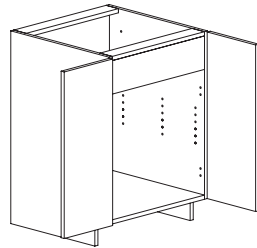

ITEM	A	B	C	D	E	F	G
EBS15FHD	694	728	763	798	854	889	930
EBS18FHD	734	770	807	844	902	939	983
EBS21FHD	775	814	853	892	954	993	1039
EBS24FHD-1	815	856	897	939	1004	1044	1093
EBS24FHD-2	972	1021	1070	1119	1196	1245	1303
EBS27FHD	1015	1066	1116	1167	1248	1300	1361
EBS30FHD	1064	1116	1170	1224	1309	1362	1425
EBS33FHD	1098	1153	1208	1263	1351	1406	1472
EBS36FHD	1137	1193	1251	1308	1399	1456	1524
EBS39FHD	1178	1237	1297	1356	1450	1509	1579
EBS42FHD	1218	1279	1340	1401	1499	1559	1632
EBS45FHD	1270	1334	1397	1461	1562	1626	1703
EBS48FHD-2	1309	1375	1441	1506	1611	1676	1756

### DOUBLE DOOR

39"W - 48-2"W

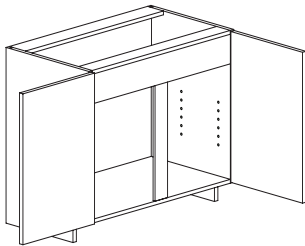

## BASE SINK REVERSE

- Drawer at Bottom
- No shelf

### SINGLE DOOR

- Specify Hinge (L or R)
- 15"W - 24-1"W

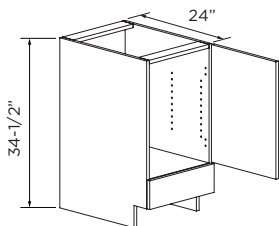

### BUTT DOORS

24-2"W - 36"W

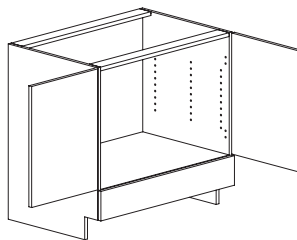

### DOUBLE DOOR

39"W - 48-2"W

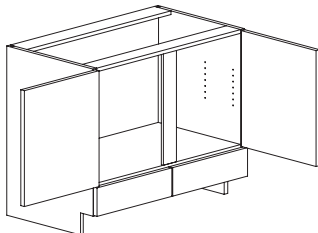

ITEM	A	B	C	D	E	F	G
EBSR15	861	905	949	990	1060	1103	1154
EBSR18	919	966	1012	1057	1131	1177	1232
EBSR21	982	1031	1081	1130	1208	1257	1317
EBSR24-1	1031	1082	1134	1186	1268	1320	1381
EBSR24-2	1163	1221	1280	1337	1430	1489	1559
EBSR27	1225	1286	1348	1410	1507	1568	1642
EBSR30	1276	1340	1405	1468	1571	1634	1710
EBSR33	1333	1400	1466	1533	1639	1707	1786
EBSR36	1389	1458	1528	1598	1709	1779	1862
EBSR39	1446	1518	1592	1664	1780	1852	1939
EBSR42	1504	1578	1654	1730	1850	1925	2016
EBSR45	1560	1638	1716	1795	1919	1998	2090
EBSR48-2	1616	1697	1779	1859	1989	2070	2166

# ELAN BASE CABINETS

## BASE SINK CABINET WITH FALSE DRAWER FRONT

- No Drawers, No Shelves

### SINGLE DOOR

- Specify Hinge (L or R)
- 15"W - 24-1"W

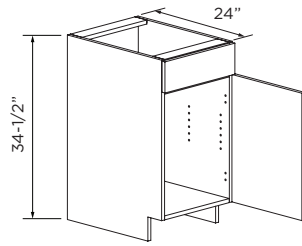

### BUTT DOORS

24-2"W - 36"W

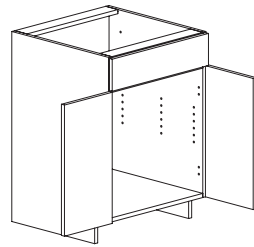

### DOUBLE DOOR

39"W - 48-2"W

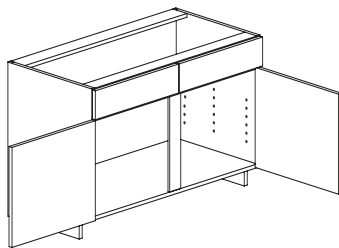

ITEM	A	B	C	D	E	F	G
EBS15	706	741	776	811	868	902	945
EBS18	751	789	826	864	924	961	1006
EBS21	800	840	880	921	984	1024	1072
EBS24-1	815	855	895	938	1000	1045	1093
EBS24-2	829	870	912	954	1020	1061	1111
EBS27	859	902	946	989	1057	1100	1153
EBS30	894	939	984	1028	1100	1144	1198
EBS33	922	968	1015	1061	1134	1181	1236
EBS36	951	999	1046	1094	1170	1218	1275
EBS39	989	1038	1088	1138	1218	1267	1326
EBS42	1024	1076	1127	1178	1260	1312	1373
EBS45	1071	1125	1178	1232	1318	1372	1435
EBS48-2	1116	1172	1229	1284	1373	1429	1496

## DROP FRONT SINK BASE FOR APRON SINK

- Cut-out to be Done on Site
- No Shelves

### BUTT DOORS

24"W - 36"W

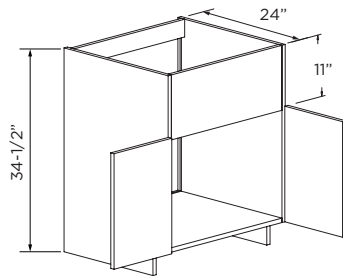

### DOUBLE DOORS

39"W - 48-2"W

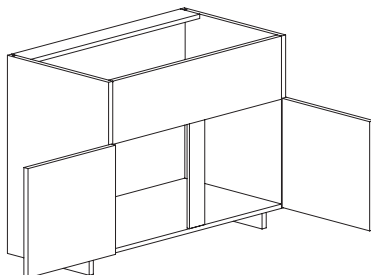

ITEM	A	B	C	D	E	F	G
EDFSB24	818	860	901	941	1008	1049	1097
EDFSB27	852	895	938	980	1049	1092	1142
EDFSB30	888	932	977	1021	1092	1137	1189
EDFSB33	914	960	1006	1053	1126	1171	1226
EDFSB36	943	990	1038	1084	1160	1207	1264
EDFSB39	980	1029	1079	1128	1207	1256	1314
EDFSB42	1016	1067	1119	1169	1251	1301	1362
EDFSB45	1053	1105	1159	1211	1296	1348	1411
EDFSB48-2	1088	1143	1197	1252	1339	1394	1458

CABINET WIDTH	MAX. CUT-OUT
24"	9-1/2"H X 22-1/2"W
27"	9-1/2"H X 25-1/2"W
30"	9-1/2"H X 28-1/2"W
33"	9-1/2"H X 31-1/2"W
36"	9-1/2"H X 34-1/2"W
39"	9-1/2"H X 37-1/2"W
42"	9-1/2"H X 40-1/2"W
45"	9-1/2"H X 43-1/2"W
48"	9-1/2"H X 46-1/2"W

**DESIGN NOTE:** To change apron height, specify custom frame arrangement.





**TABLE OF CONTENTS**

**ELAN BASE CORNER CABINETS.....E600-1 thru E600-6**

Blind Corner Base Cabinets.....	E600-2
Base Square Corner.....	E600-3
Base Square Corner with Lazy Susan.....	E600-3
Base Square Corner 3 Drawer.....	E600-3
Square Corner Sink Base.....	E600-4
Base Diagonal Corner.....	E600-4
Diagonal Corner Sink Base.....	E600-5
Peninsula Base Square Corner.....	E600-5
Peninsula Base Corner.....	E600-6
Peninsula Base Diagonal Corner.....	E600-6
Peninsula Blind Base Corner.....	E600-6



# ELAN BASE CORNER CABINETS

## BLIND BASE CABINETS

- L or R Indicates Blind. (Door is always hinged on blind side) Blind Shown is Right.
- 27" blind panel. Cabinet does not need to be pulled from the corner, but can be pulled for additional clearance.  
A filler is recommended for the adjacent cabinet.
- Door Hinged on Blind Side.

**DESIGN NOTE:** Width modifications affect the door area.

## BLIND BASE CORNER

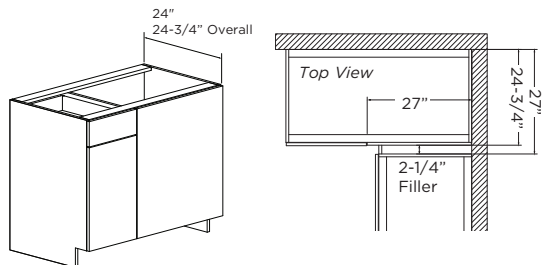

ITEM	A	B	C	D	E	F	G	DOOR SECTION WIDTH	BLIND WIDTH
1 Adjustable Shelf, 1 Drawer									
EXBC36	1055	1108	1161	1214	1298	1351	1414	9"	27"
EXBC39	1125	1181	1237	1293	1384	1440	1507	12"	27"
EXBC42	1174	1232	1291	1350	1444	1502	1573	15"	27"
EXBC45	1263	1326	1390	1452	1554	1617	1693	18"	27"
EXBC48	1366	1434	1502	1571	1680	1748	1830	21"	27"

## BLIND BASE CORNER WITH FULL SHELF TURN-OUT

- Wood Shelf Turns Out
- Decrease Depth Not Available

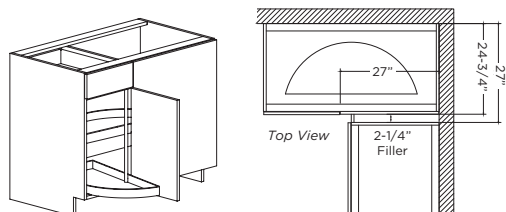

ITEM	A	B	C	D	E	F	G	DOOR SECTION WIDTH	BLIND WIDTH
2 Wood Half Moon Shelves, 1 Drawer									
EXBCTO45	2323	2439	2555	2671	2857	2973	3112	18"	27"
EXBCTO48	2347	2465	2582	2699	2888	3005	3145	21"	27"

## BLIND BASE CORNER WITH CHROME SLIDE-OUT STORAGE

- Do Not Place Next to an Appliance
- Decrease Depth NOT Available

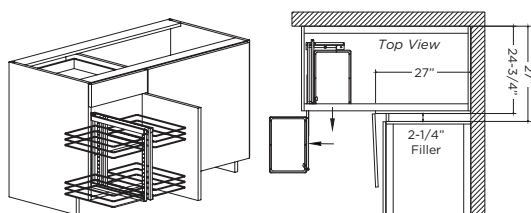

ITEM	A	B	C	D	E	F	G	DOOR SECTION WIDTH	BLIND WIDTH
1 Drawer									
EXBCSO48-W	3044	3197	3348	3501	3745	3897	4079	21"	27"

## BLIND BASE CORNER WITH CHROME RAILS

- Two pivoting shelves swing out and extend independently for easy access to blind area. Wood shelves with chrome rails.
- 65 lb. capacity for each shelf.
- Do Not Place Next to an Appliance
- Decrease Depth NOT Available

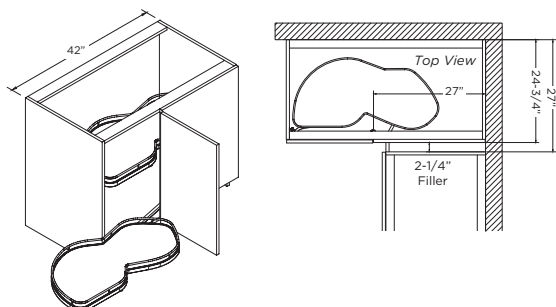

ITEM	A	B	C	D	E	F	G	DOOR SECTION WIDTH	BLIND WIDTH
EXBCK48	2628	2696	2764	2833	2942	3010	3092	21"	27"

# ELAN BASE CORNER CABINETS

## BASE SQUARE CORNER

- 1 Adjustable Shelf, Full Depth
- 170° Hinges
- Specify Hinge (L or R)
- Decrease Depth Not Available

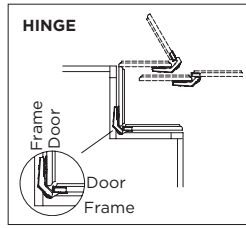
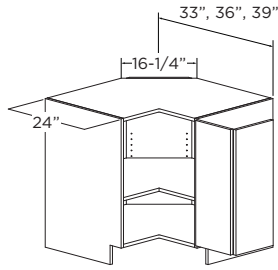

ITEM	A	B	C	D	E	F	G
EBSC33*	1243	1306	1368	1430	1529	1592	1666
EBSC36	1396	1466	1537	1606	1718	1787	1872
EBSC39	1555	1633	1712	1789	1913	1991	2084
EBSC42	1709	1795	1880	1966	2103	2188	2291

\* 3" Stile/Rail Door Styles will have a slab door.

## BASE SQUARE CORNER WITH LAZY SUSAN

- Lower Tray is Mounted to Cabinet Floor, Upper Tray is Mounted to Adjustable Shelf
- Specify Hinge (L or R)
- Decrease Depth Not Available

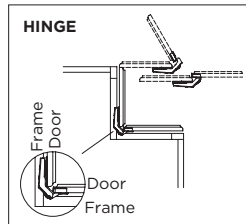
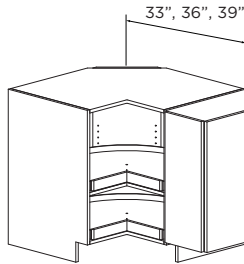

33" Wide Cabinet  
27" Diameter Wood Lazy Susan Trays  
36" & 39" Wide Cabinet  
30" Diameter Wood Lazy Susan Trays

ITEM	A	B	C	D	E	F	G
EBSCLS33*	1639	1721	1804	1886	2017	2099	2197
EBSCLS36	1837	1929	2022	2114	2260	2352	2463
EBSCLS39	2035	2137	2240	2341	2504	2606	2729

\*3" Stile/Rail Door Styles be slab for the 33"

## BASE SQUARE CORNER LAZY SUSAN WITH CHROME RAILS

- Specify Hinge (L or R)
- Decrease Depth Not Available
- Two wood lazy susan trays with chrome rails mounted on floor and adjustable shelf.

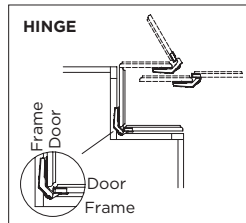
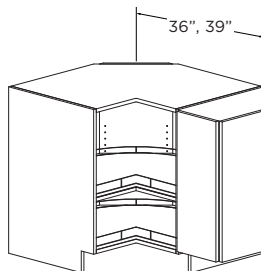

36" Wide Cabinet  
28" Diameter Wood Lazy Susan Trays  
39" Wide Cabinet  
32" Diameter Wood Lazy Susan Trays

ITEM	A	B	C	D	E	F	G
EBSCLSK36	3288	3380	3473	3565	3711	3803	3914
EBSCLSK39	3555	3657	3760	3861	4024	4126	4249

## BASE SQUARE CORNER THREE DRAWER

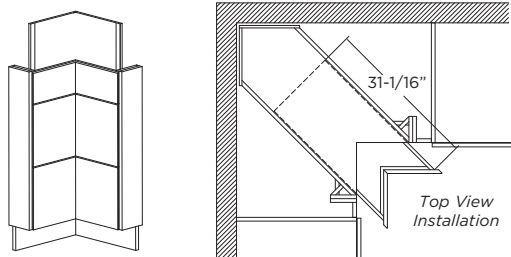

ITEM	A	B	C	D	E	F	G
3 Drawers							
EBSC3D36	3512	3688	3864	4039	4320	4496	4707

# ELAN BASE CORNER CABINETS

## SQUARE CORNER SINK BASE

- No Shelf
- Solid Top-Must be Cut For Sink At Job Site
- Specify Hinge (L or R)
- Decrease Depth Not Available

ITEM	A	B	C	D	E	F	G
ESCSB36	1143	1200	1258	1315	1407	1463	1532
ESCSB39	1248	1311	1374	1436	1535	1598	1674
ESCSB42	1347	1414	1483	1550	1658	1725	1806

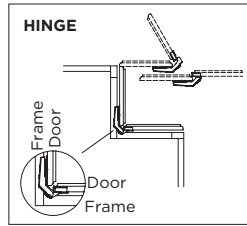
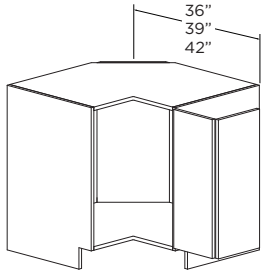

## BASE DIAGONAL CORNER

- Specify Hinge (L or R)
- Decrease Depth Not Available

ITEM	A	B	C	D	E	F	G
1 Adjustable Shelf							
EBDC33	1298	1363	1429	1494	1598	1663	1741
EBDC36	1452	1524	1598	1671	1787	1859	1946
EBDC39	1647	1729	1812	1895	2026	2109	2207
EBDC42	1835	1927	2020	2111	2258	2350	2460

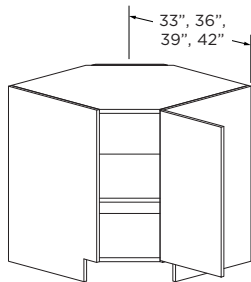

**DESIGN NOTE:** DO NOT use next to an appliance.

## BASE DIAGONAL CORNER WITH LAZY SUSAN

- Specify Hinge (L or R)
- Decrease Depth Not Available

ITEM	A	B	C	D	E	F	G
2 Lazy Susan Trays, 1 Adjustable Shelf							
EBDCLS33	1617	1698	1780	1861	1990	2071	2167
EBDCLS36	1720	1806	1892	1979	2116	2202	2306

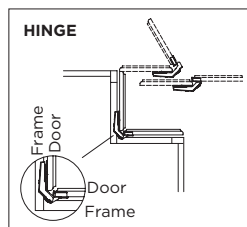
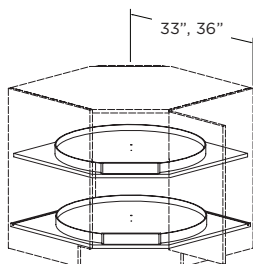

33" Wide Cabinet  
27" Diameter Wood Lazy Susan Trays

36" Wide Cabinet  
30" Diameter Wood Lazy Susan Trays

**DESIGN NOTE:** DO NOT use next to an appliance.

# ELAN BASE CORNER CABINETS

## DIAGONAL CORNER SINK BASE

- No Shelf
- Solid Top-Must be Cut For Sink At Job Site
- Decrease Depth Not Available

### SINGLE DOOR

- Specify Hinge (L or R)
- 36"W - 42-1"W

### BUTT DOORS

42-2"W

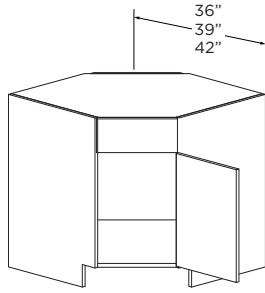

**DESIGN NOTE:** DO NOT use next to an appliance.

ITEM	A	B	C	D	E	F	G
EDCSB36	1359	1428	1496	1564	1672	1741	1823
EDCSB39	1427	1498	1570	1642	1756	1826	1912
EDCSB42-1	1501	1576	1652	1727	1847	1922	2012
EDCSB42-2	1601	1682	1762	1842	1971	2050	2147

## DIAGONAL CORNER SINK BASE FULL HEIGHT DOOR

- No Shelf
- Solid Top-Must be Cut For Sink At Job Site
- Decrease Depth Not Available

### SINGLE DOOR

- Specify Hinge (L or R)
- 36"W - 42-1"W

### BUTT DOORS

42-2"W

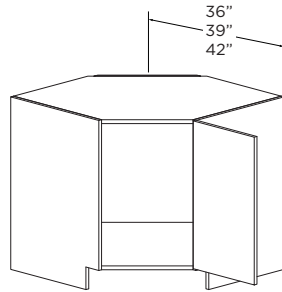

**DESIGN NOTE:** DO NOT use next to an appliance.

ITEM	A	B	C	D	E	F	G
EDCSB36FHD	1234	1295	1357	1419	1518	1579	1654
EDCSB39FHD	1346	1413	1482	1549	1656	1724	1804
EDCSB42FHD-1	1462	1535	1609	1682	1800	1872	1960
EDCSB42FHD-2	1559	1637	1715	1793	1918	1995	2089

## PENINSULA BASE SQUARE CORNER

- Use For Starting A Peninsula
- Specify Peninsula Side (L or R)
- Specify Hinge (L or R)
- Decrease Depth Not Available
- 1 Adjustable Shelf, Full Depth

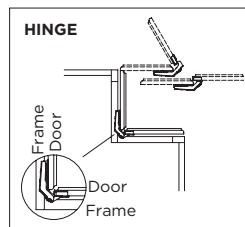
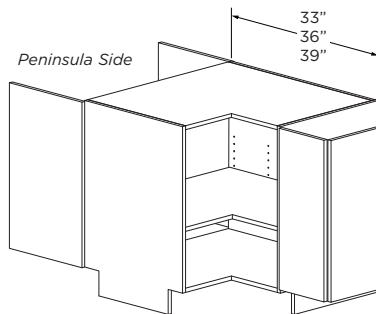

ITEM	A	B	C	D	E	F	G
1 Adjustable Shelf							
EPBSC33	1793	1883	1973	2064	2207	2296	2403
EPBSC36	2073	2177	2281	2385	2551	2654	2779
EPBSC39	2237	2350	2461	2573	2752	2864	2999

# ELAN BASE CORNER CABINETS

## PENINSULA BASE CORNER

- Measures 27" x 27" With Integral Corner Filler
- Use for Starting a Peninsula
- Decrease Depth Not Available

ITEM	A	B	C	D	E	F	G
EPBC27	1686	1770	1855	1939	2075	2159	2259
EPBC27FHD	1466	1539	1612	1686	1803	1877	1965

## BUTT DOORS

- Specify Peninsula (PL or PR)
- 1 Drawer (Peninsula Side)
- 1 Adjustable Shelf, Full Depth

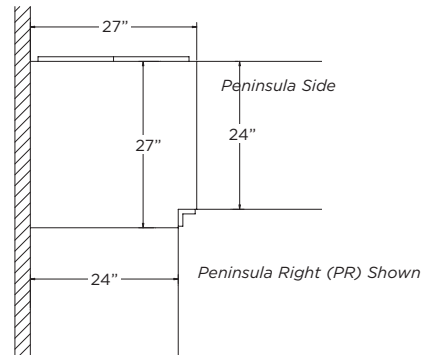
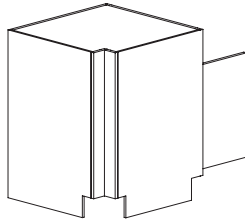

## FULL HEIGHT BUTT DOORS

- Specify Peninsula (PL or PR)
- 1 Adjustable Shelf, Full Depth

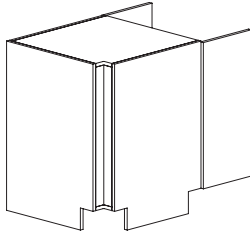

## PENINSULA BASE DIAGONAL CORNER

- Use For Starting a Peninsula
- Specify Hinge (L or R)
- Specify Peninsula Side (L or R)
- Decrease Depth Not Available

ITEM	A	B	C	D	E	F	G
1 Adjustable Shelf							
EPBDC33	1862	1955	2049	2142	2291	2384	2495
EPBDC36	1897	1993	2088	2182	2334	2429	2543
EPBDC39	2072	2150	2253	2356	2520	2621	2745

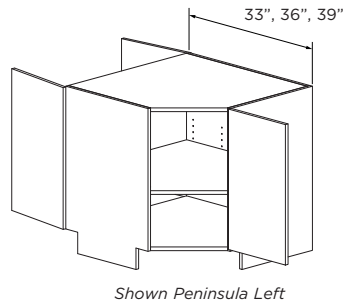

**DESIGN NOTE:** DO NOT use next to an appliance.

## PENINSULA BLIND BASE CORNER

- Full Depth Shelf
- Use for Starting a Peninsula
- 27" blind panel. Cabinet does not need to be pulled from the corner, but can be pulled for additional clearance. A filler is recommended for the adjacent cabinet.

ITEM	A	B	C	D	E	F	G	DOOR SECTION WIDTH	BLIND WIDTH
2 Drawers									
EPXBC39	1905	2000	2095	2191	2344	2439	2553	12"	27"
EPXBC45	2038	2139	2242	2345	2507	2609	2731	18"	27"

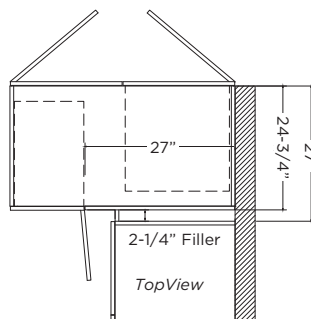
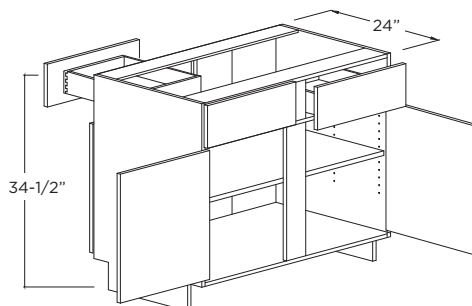

**DESIGN NOTE:** When changing width the door section changes.



**TABLE OF CONTENTS**

**ELAN BASE SPECIALTY CABINETS.....E700-1 thru E700-16**

Recycle Center Cabinets .....	E700-2
Base Pull-Out.....	E700-3
Bottle Storage Base.....	E700-3
Base Mixer Cabinet .....	E700-3
Base with Charging Drawer.....	E700-3
Tall Lid Storage Base .....	E700-3
Base Pull-Out Tray Divider .....	E700-4
Base Pull-Out Spice Rack.....	E700-4
Base Pull-Out Peg Board.....	E700-4
Base Pull-Out with Utensil Bins.....	E700-4
Base Pull-Out with Utensil Bins/Knife Block .....	E700-4
Base Pull-Out Filler .....	E700-5
Baking Center.....	E700-5
Base with Condiment Drawers.....	E700-5
Base Wine Storage Cube.....	E700-5
Microwave Base.....	E700-6
Range Base with Drawers .....	E700-6
Drop-In Range Cabinet with Front Panel.....	E700-6
Downdraft Range Base .....	E700-7
Range Base .....	E700-7
Range Base Panel .....	E700-7
Undercounter Oven Frame.....	E700-7
Range Base Drawer .....	E700-7
Angle Corner/Corner Angle Cabinets/Base End Shelf .....	E700-8
Base File Drawer .....	E700-9
Desk Drawer with End Panel.....	E700-9
Desk Drawer .....	E700-9
Computer Keyboard Drawer.....	E700-9
Base End Shelf.....	E700-9
Island Post Ends.....	E700-10
Island Box Ends .....	E700-11
Base Accessories .....	E700-12 thru E700-16



# ELAN BASE SPECIALTY CABINETS

## RECYCLE CENTER - STYLE B

- Double wastebasket
- Dimensional Mod Not Available
- Cabinet has intermediate floor to separate waste area from drawer above.

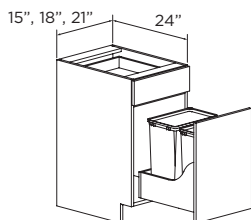

ITEM	A	B	C	D	E	F	G
2 - 27 QT. Wastebasket							
ERCB15ATD	1389	1458	1528	1598	1709	1779	1862
2 - 35 QT. Wastebasket							
ERCB18ATD	1443	1515	1587	1659	1775	1847	1934
ERCB21ATD	1496	1571	1647	1721	1841	1916	2006

## RECYCLE CENTER - STYLE E

- Tray behind wastebasket for wastebasket liners.
- Dimensional Mod Not Available
- Cabinet has intermediate floor to separate waste area from drawer above.

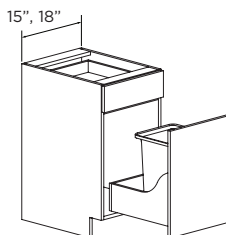

ITEM	A	B	C	D	E	F	G
1 - 35 QT. Wastebasket							
ERCE15ATD	1438	1510	1582	1654	1769	1841	1927
ERCE18ATD	1545	1622	1700	1778	1901	1978	2071

## RECYCLE CENTER - STYLE F

- Full Height Door Attached
- Dimensional Mod Not Available

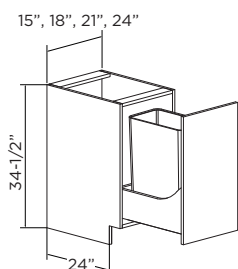

ITEM	A	B	C	D	E	F	G
1- 50 QT. Wastebasket							
ERCF15ATD	1471	1510	1549	1586	1649	1681	1727
ERCF18ATD	1537	1578	1620	1658	1723	1763	1811
ERCF21ATD	1603	1646	1691	1730	1797	1845	1895
ERCF24ATD	1669	1714	1762	1802	1871	1927	1979

## RECYCLE CENTER - STYLE K

- Chrome Wire Surround with Single or Double Wastebasket
- Dimensional Mod Not Available
- Cabinet has intermediate floor to separate waste area from drawer above.

ITEM	A	B	C	D	E	F	G
1 - 35 QT. Wastebasket							
ERCK15ATD	1489	1527	1566	1604	1665	1703	1749
2 - 35 QT. Wastebasket							
ERCK18ATD	1544	1585	1626	1667	1731	1772	1821

## SINGLE WASTEBASKET

## DOUBLE WASTEBASKET

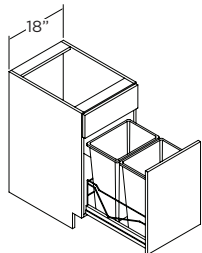
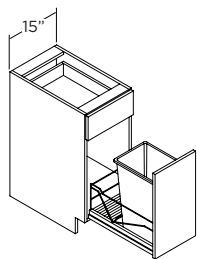

## RECYCLE CENTER - STYLE R

- Rev-A-Shelf Double wastebasket.
- Soft Motion Undermount Glides
- Dimensional Mod Not Available
- Cabinet has intermediate floor to separate waste area from drawer above.

ITEM	A	B	C	D	E	F	G
2 - 35 QT. Wastebasket							
ERCR18ATD	1629	1670	1711	1752	1816	1857	1906
ERCRCBD18ATD	2189	2230	2271	2312	2376	2417	2466

## NO CUTTING BOARD

## REMOVABLE CUTTING BOARD IN DRAWER

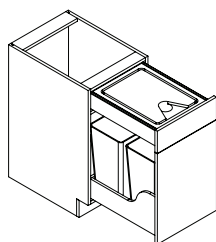
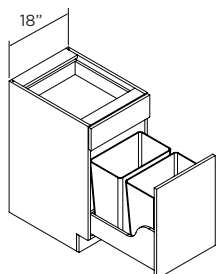

Wood cutting board has funnel (through the drawer below) to allow food cutting to drop into waste unit below.



# ELAN BASE SPECIALTY CABINETS

## BASE PULL-OUT

- 24" Deep Only
- Pull-out Unit has 2 Adjustable Shelves with Chrome Wire Surround

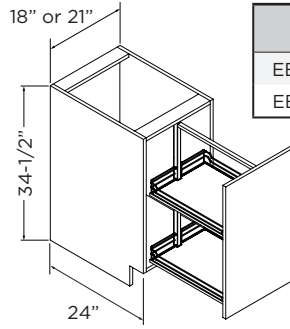

ITEM	A	B	C	D	E	F	G
EBPOK18ATD	1821	1855	1889	1923	1977	2011	2053
EBPOK21ATD	2046	2083	2119	2156	2215	2251	2295

## BOTTLE STORAGE BASE

- Specify Hinge (L or R)
- Roll-Out Tray With 8 Bottle Dividers
- Bottle Tray 4-1/16" High

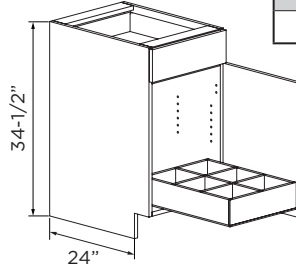

ITEM	A	B	C	D	E	F	G
EBSB18	1312	1378	1444	1509	1614	1680	1758

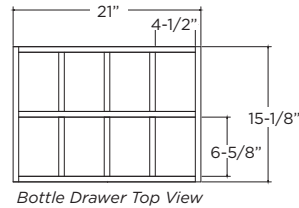

## BASE MIXER CABINET

- Specify Hinge (L or R)
- Full Height Door
- Swing Up Shelf for Appliances
- Weight Capacity 50 lbs.
- Fits mixer up to 16-1/2"H, 12"W, 14-1/2"D
- 34-1/2" High x 24" Deep Only

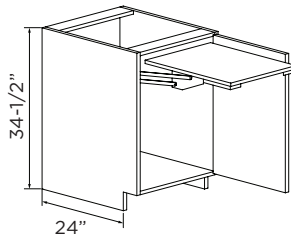

ITEM	A	B	C	D	E	F	G
EBMC15T	1244	1296	1347	1398	1480	1532	1593
EBMC18T	1308	1363	1417	1472	1559	1614	1678
EBMC21T	1369	1427	1484	1541	1634	1692	1760

## BASE WITH CHARGING DRAWER

- Rev-A-Shelf Charging Drawer
- Full Extension Soft Motion Glides
- (2) 120V Plugs and (2) 2.1 amp USB Ports
- Power Cord with Nema 5-15 Plug
- Specify Hinge (L or R)
- Dimension Changes Not Available

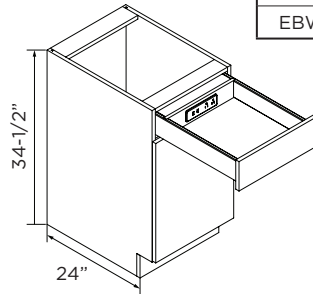

ITEM	A	B	C	D	E	F	G
1 Adjustable Shelf							
EBWCHD18	1821	1862	1903	1944	2008	2049	2098

## TALL LID STORAGE BASE

- 1 Roll Tray on Bottom
- For Pot/Pan Storage, Lid Storage Above

ITEM	A	B	C	D	E	F	G
ETLSB24-1	1571	1649	1729	1807	1933	2011	2105
ETLSB24-2	1620	1700	1782	1863	1993	2073	2171
ETLSB27	1626	1708	1789	1870	2000	2082	2180
ETLSB30	1752	1840	1928	2015	2155	2243	2348
ETLSB33	1902	1998	2093	2188	2340	2435	2550
ETLSB36	2012	2112	2214	2314	2476	2576	2697

## SINGLE DOOR

24-1"W

## BUTT DOORS

24-2"W - 36"W

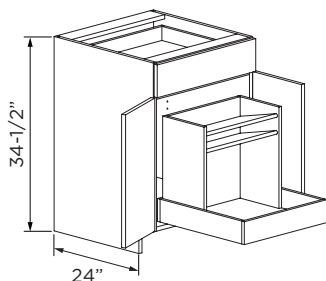

# ELAN BASE SPECIALTY CABINETS

## BASE PULL-OUT TRAY DIVIDER

- Removable Dividers

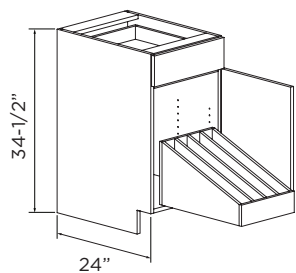

ITEM	A	B	C	D	E	F	G	# of Dividers
EB12POTD	1297	1362	1428	1493	1597	1661	1738	2
EB15POTD	1423	1494	1566	1637	1751	1822	1907	3
EB18POTD	1476	1549	1623	1698	1815	1889	1978	3
EB21POTD	1696	1780	1866	1951	2087	2171	2273	5
EB24POTD-1	1727	1814	1901	1987	2125	2212	2315	5
EB24POTD-2	1804	1895	1985	2076	2220	2311	2418	5

## BASE PULL-OUT SPICE RACK

- Accessible From Both Sides
- 3 Adjustable Shelves
- Decreased Depth not Available

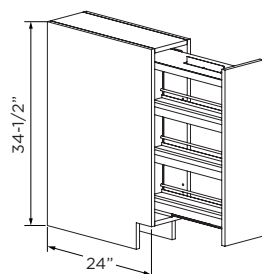

ITEM	A	B	C	D	E	F	G
EBPSR9	956	1004	1053	1100	1176	1224	1281
EBPSR12	1088	1143	1197	1252	1339	1394	1458
EBPSR15	1218	1279	1340	1401	1499	1559	1632

## BASE PULL-OUT PEG BOARD

- Accessible From Both Sides
- Specify Peg Board Side Left or Right

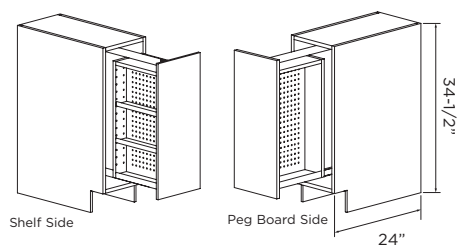

ITEM	A	B	C	D	E	F	G
2 Adjustable Shelves on One Side, Peg Board on One Side							
EBPOP9*	1137	1194	1251	1308	1399	1456	1524
EBPOP12	1183	1242	1302	1362	1456	1516	1587
EBPOP15	1231	1292	1355	1417	1515	1576	1650

**DESIGN NOTE:** \*9" Wide Cabinets will have Peg Board on one side with no shelves. Specify which side is to have Peg Board.

## BASE PULL-OUT WITH UTENSIL BINS

- Three Stainless Steel Utensil Bins
- Accessible From Both Sides
- Adjustable Shelves
- Dimension Change not Available

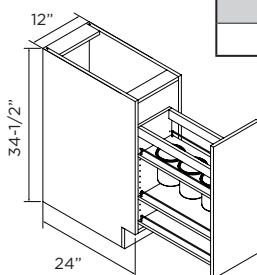

ITEM	A	B	C	D	E	F	G
EBPOUB12	1559	1588	1617	1647	1694	1724	1746

## BASE PULL-OUT WITH UTENSIL BINS/KNIFE BLOCK

- One stainless steel utensil bin, adjustable knife block and cutting mats.
- Accessible From Both Sides, Adjustable
- Dimension Change not Available

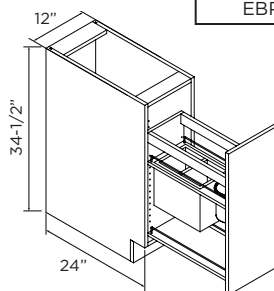

ITEM	A	B	C	D	E	F	G
EBPOKB12	1827	1856	1885	1915	1962	1992	2014

# ELAN BASE SPECIALTY CABINETS

## BASE PULL-OUT FILLER

- 24" Deep (Including the Front Filler)
- Must be Installed Between Cabinets.
- Specify Shelves Left or Right on 3" Wide

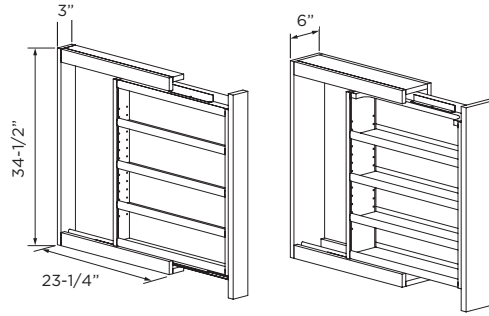

ITEM	PRICE
3"W, Accessible from one side 3 Adjustable Shelves	
EBPOF3	764
6"W, Accessible from both sides 3 Adjustable Shelves	
EBPOF6	954

**DESIGN NOTE:** Attach an overlay filler or split turning to the front for a designer look.

## BAKING CENTER

- 31" or 34-1/2" High x 24" deep
- 1- Utensil Drawers, Knife Block, Tray Storage
- 1-2 Roll trays (Depending on Height Option Selected)

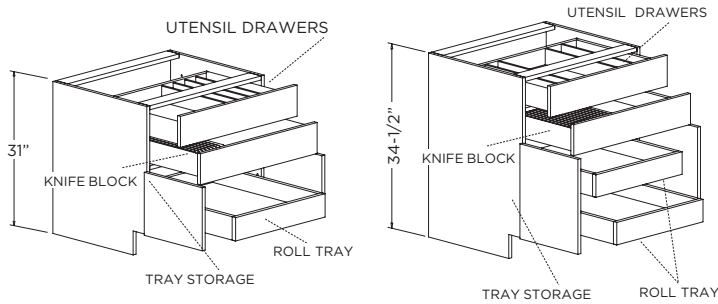

ITEM	A	B	C	D	E	F	G
1 Roll Tray							
EBAK30	2383	2499	2616	2734	2921	3037	3177
EBAK33	2414	2533	2652	2770	2960	3077	3219
EBAK36	2449	2568	2690	2809	3001	3121	3265
2 Roll Trays							
EBAK30T	2960	3103	3247	3390	3619	3762	3933
EBAK33T	3011	3156	3303	3449	3682	3828	4002
EBAK36T	3061	3209	3358	3506	3743	3891	4070

## BASE WITH CONDIMENT DRAWERS

- Wood drawer tracks
- Drawer Box will be stained and finished to match exterior.
- Available in standard wood species only.
- Decrease depth not available.

ITEM	PRICE
EBCD9	815

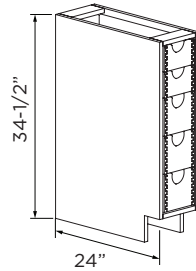

## BASE WINE STORAGE CUBE

- Finished Interior & Exterior

ITEM	PRICE	# OF CUBES
EBWSC6	930	6
EBWSC12	1247	12

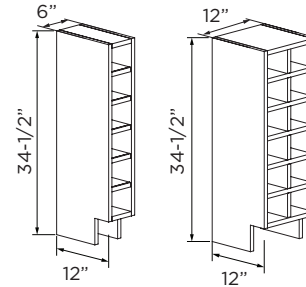

# ELAN BASE SPECIALTY CABINETS

## MICROWAVE BASE

### STYLE A

- 1 Drawer
- Microwave cabinet shipped with solid panel.
- Specify Appliance Cutout, if needed, No Charge.

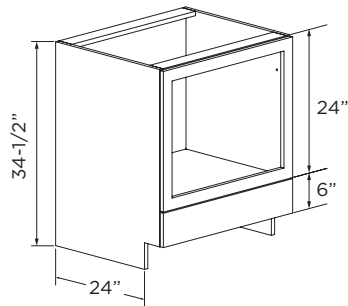

STYLE A	A	B	C	D	E	F	G
Max. Cutout: 21"W X 21"H							
EMBA24	1724	1795	1864	1935	2048	2118	2202
Max. Cutout: 24"W X 21"H							
EMBA27	1754	1827	1899	1971	2087	2157	2243
Max. Cutout: 27"W X 21"H							
EMBA30	1809	1884	1959	2033	2153	2228	2317

### STYLE B

- 1 Drawer
- Finished Interior

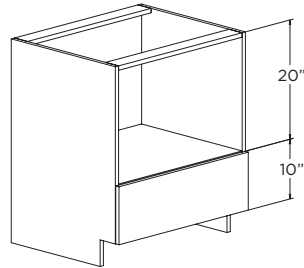

STYLE B	A	B	C	D	E	F	G
Opening: 22-1/2"W X 19-1/4"H							
EMBB24	1399	1468	1539	1609	1721	1791	1874
Opening: 25-1/2"W X 19-1/4"H							
EMBB27	1444	1516	1589	1661	1776	1874	1935
Opening: 28-1/2"W X 19-1/4"H							
EMBB30	1490	1565	1639	1714	1834	1908	1998

## RANGE BASE WITH DRAWERS

- False Header Panel Top

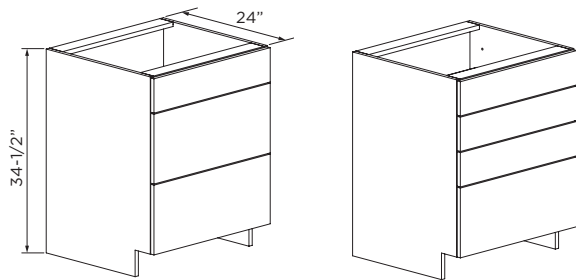

2-DRAWERS	A	B	C	D	E	F	G
ERB2D27	1537	1614	1691	1768	1891	1967	2060
ERB2D30	1603	1683	1764	1844	1972	2053	2148
ERB2D33	1675	1759	1842	1927	2061	2144	2245
ERB2D36	1737	1824	1912	1999	2137	2224	2329

3-DRAWERS	A	B	C	D	E	F	G
ERB3D27	1774	1863	1952	2040	2182	2271	2378
ERB3D30	1853	1946	2039	2132	2280	2373	2484
ERB3D33	1934	2031	2128	2225	2379	2476	2592
ERB3D36	2010	2110	2212	2312	2473	2573	2693

## DROP-IN RANGE CABINET WITH FRONT PANEL

- Specify Appliance Cutout, if Needed, No Charge

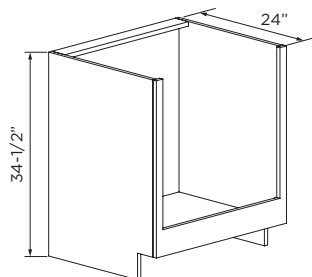

ITEM	PRICE
Max. Cutout Width 24"	
EDIP27	1058
Max. Cutout Width 27"	
EDIP30	1108
Max. Cutout Width 30"	
EDIP33	1174

**DESIGN NOTE:** Orders not specifying cut-out size will have solid panel, shipped unattached

# ELAN BASE SPECIALTY CABINETS

## DOWNDRAFT RANGE BASE

- Reduced Depth Drawer and Shelf for Duct Clearance
- For Duct Clearance in Rear Section of Cabinet

### BUTT DOORS

30"W - 36"W

### DOUBLE DOORS

42"W

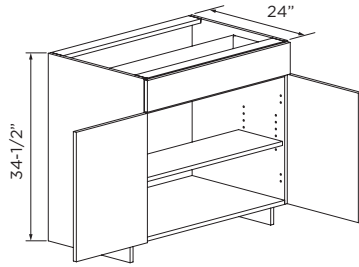

ITEM	A	B	C	D	E	F	G
EDRB30	1320	1386	1452	1518	1625	1691	1770
EDRB36	1531	1608	1685	1760	1883	1960	2051
EDRB42	1759	1847	1935	2023	2164	2252	2358

## RANGE BASE

- False Header Panel Top
- Full Depth Shelf

### BUTT DOORS

27"W - 36"W

### DOUBLE DOORS

42"W

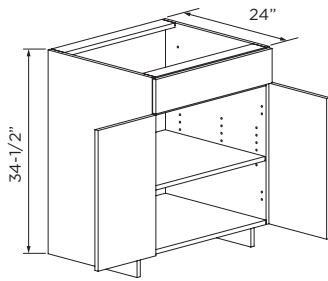

ITEM	A	B	C	D	E	F	G
ERB27	1111	1166	1223	1279	1368	1423	1490
ERB30	1159	1216	1275	1334	1427	1484	1554
ERB33	1205	1265	1326	1386	1483	1544	1616
ERB36	1289	1353	1418	1483	1586	1650	1727
ERB42	1369	1438	1506	1575	1685	1753	1835

## RANGE BASE PANEL

- Maximum Height: 18"
- Specify Height
- Shipped Unassembled

ITEM	PRICE
ERBP30	199
ERBP33	214

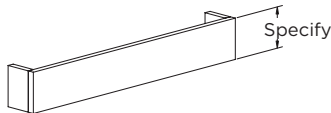

**DESIGN NOTE:** Orders not specifying panel height will be shipped 12" plain panel for job-site trimming.

## UNDERCOUNTER OVEN FRAME

- 3" Framing
- Maximum Cutout is 3" Less Than Frame Width or Height

ITEM	PRICE
EUCOFF30	345
EUCOFF33	352

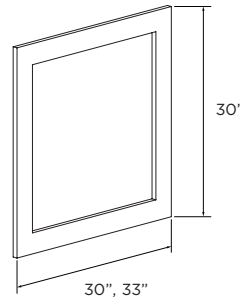

## RANGE BASE DRAWER

- 24" Deep
- Minimum Height 10-1/2", Maximum Height 18"
- Specify Height

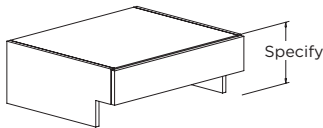

ITEM	A	B	C	D	E	F	G
ERBD27	686	720	756	790	845	879	919
ERBD30	809	850	891	932	996	1037	1086
ERBD33	881	925	971	1015	1084	1128	1182

# ELAN BASE SPECIALTY CABINETS

## BASE ANGLE CORNER

- Full Height Doors
- Full Depth Adjustable Shelf

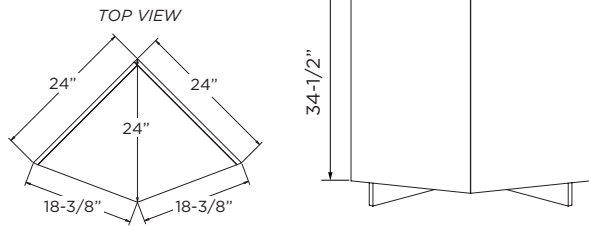

ITEM	A	B	C	D	E	F	G
EBAC24	1219	1280	1341	1402	1500	1561	1633

## BASE CORNER ANGLE

- Full Height Doors
- 1 Adjustable Shelf

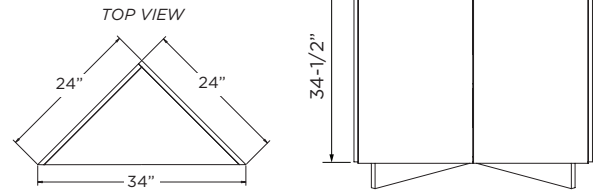

ITEM	A	B	C	D	E	F	G
EBCA24	1171	1230	1289	1347	1441	1500	1570

## BASE END SHELF

- Specify Shelves (L or R)
- 6" Radius

ITEM	PRICE
EBES	628

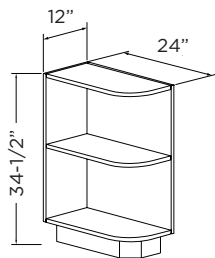

Shelves Shown Left

# ELAN BASE SPECIALTY CABINETS

## BASE FILE DRAWER

- Specify Depth 21" or 24"
- File Drawer(s) Have Full Extension Side Mounted Glides
- Includes a Standard Pendaflex File System

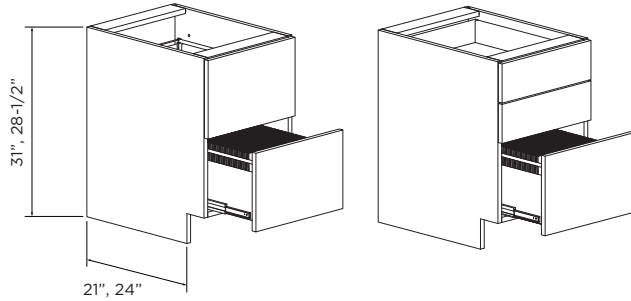

2-DRAWERS	A	B	C	D	E	F	G
<b>31" HIGH</b>							
EBF2D18	1095	1150	1205	1260	1348	1402	1468
EBF2D21	1155	1213	1271	1329	1422	1479	1549
<b>28-1/2" HIGH</b>							
EBF2D1828	1095	1150	1205	1260	1348	1402	1468
EBF2D2128	1155	1213	1271	1329	1422	1479	1549

3-DRAWERS	A	B	C	D	E	F	G
<b>31" HIGH</b>							
EBF3D18	1347	1414	1483	1550	1658	1725	1806
EBF3D21	1407	1478	1549	1619	1731	1802	1886
<b>28-1/2" HIGH</b>							
EBF3D1828	1347	1414	1483	1550	1658	1725	1806
EBF3D2128	1407	1478	1549	1619	1731	1802	1886

## DESK DRAWER WITH END PANEL

- 28-1/2"H or 31"H
- Specify Depth 18", 21" or 24"
- Specify End Panel (L or R)
- Full Extension Glide

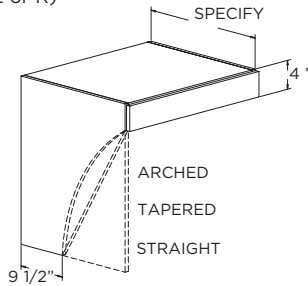

ITEM	PRICE
<b>STRAIGHT</b>	
EDDEPS24	549
EDDEPS27	604
EDDEPS30	656
EDDEPS33	721
EDDEPS36	779

ITEM	PRICE
<b>TAPERED</b>	
EDDEPT24	555
EDDEPT27	605
EDDEPT30	658
EDDEPT33	718
EDDEPT36	773

ITEM	PRICE
<b>ARCHED</b>	
EDDEPA24	560
EDDEPA27	609
EDDEPA30	655
EDDEPA33	714
EDDEPA36	767

## DESK DRAWER

- Specify Depth: 18", 21", or 24"
- 5 Piece Drawer Styles will be Slab

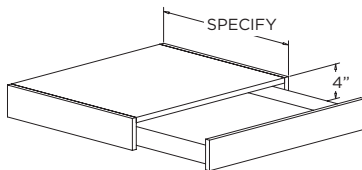

ITEM	PRICE
EDD24	367
EDD27	399
EDD30	436
EDD33	477
EDD36	516

## COMPUTER KEYBOARD DRAWER

- Hinged drawer front with pull out shelf

ITEM	PRICE
ECKD30	500
ECKD36	605

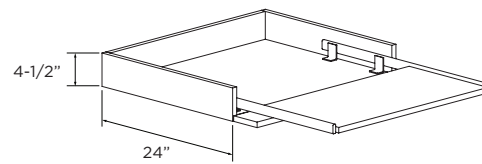

# ELAN BASE SPECIALTY CABINETS

## ISLAND POST ENDS

- Finished all 4 sides for use with knee space or island end cap.
- Specify 3" or 6" post style. Example: ISLPEP6, Chamfer Post

### 3" POST OPTIONS

### 6" POST OPTIONS

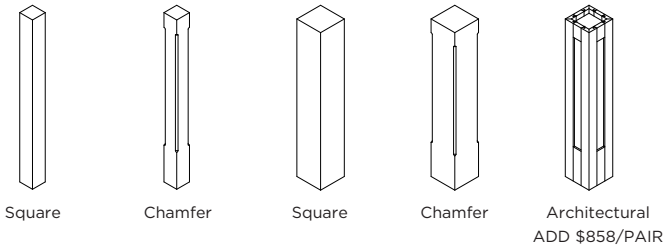

3" WIDE		PRICE	6" WIDE		PRICE	6" WIDE		PRICE
PLAIN			PLAIN			SHALLOW		
ISLPEP338	1807		ISLPEP638	2234	ISLPESC638	3053		
ISLPEP344	1953		ISLPEP644	2409	ISLPESC644	3170		
ISLPEP350	2110		ISLPEP650	2598	ISLPESC650	3297		
SHIPLAP			SHIPLAP					
ISLPES338	2116		ISLPES638	2532				
ISLPES344	2265		ISLPES644	2709				
ISLPES350	2424		ISLPES650	2900				
DECORATIVE			DECORATIVE					
ISLPED338	2351		ISLPED638	2876				
ISLPED344	2523		ISLPED644	3005				
ISLPED350	2707		ISLPED650	3135				
STYLE X			STYLE X					
ISLPEX338	3826		ISLPEX638	4325				
ISLPEX344	4002		ISLPEX644	4449				
ISLPEX350	4191		ISLPEX650	4576				

### PLAIN

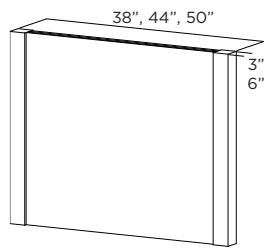

- ISLPEP3 Shown

### SHIPLAP

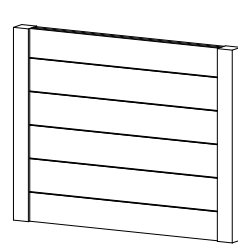

- ISLPES3 Shown
- Shiplap Both Sides

### DECORATIVE

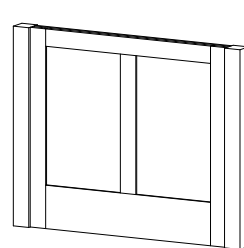

- ISLPED3 Shown
- Finished Panel on Back

### STYLE X

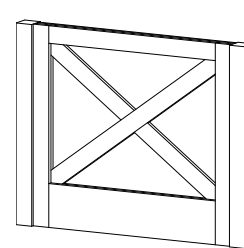

- ISLPEX3 Shown
- Finished Panel on Back

### SHALLOW CABINET

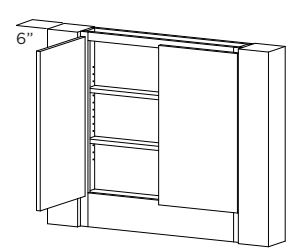

- ISLPESC6 Shown
- Available for 6" Unit Only
- Finished Panel on Back

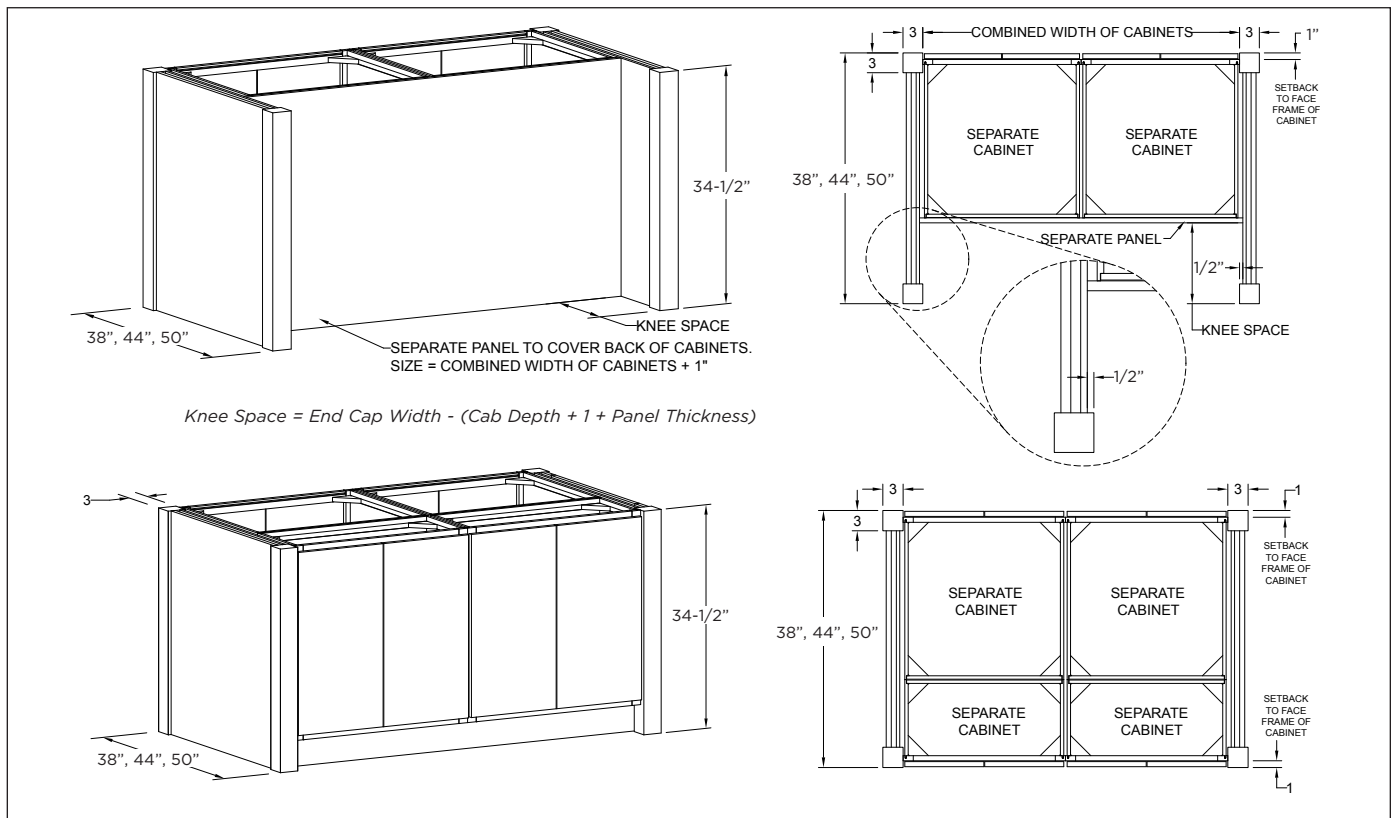

**DESIGN NOTE:** 6" Architectural Post Option, side facing in will be blank. Only available in standard wood species.



# ELAN BASE SPECIALTY CABINETS

## ISLAND BOX ENDS

- Finished All 4 Sides for Use with Knee Space or Island End Cap
- Mitered Corners

### PLAIN

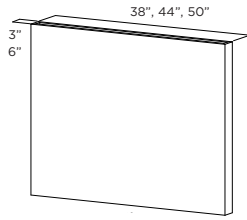

- ISLBEP3 Shown

### SHIPLAP

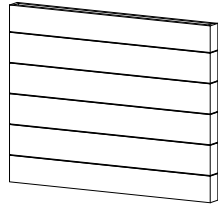

- ISLBES3 Shown
- Shiplap All 4 Sides.

### DECORATIVE

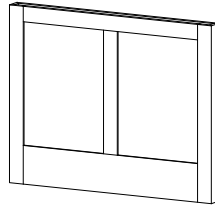

- ISLBED3 (Under 45\")
- Finished Panel on Back

3\" WIDE	PRICE	6\" WIDE	PRICE
PLAIN		PLAIN	
ISLBEP-338	1598	ISLBEP-638	1713
ISLBEP-344	1649	ISLBEP-644	1767
ISLBEP-350	1701	ISLBEP-650	1821
SHIPLAP		SHIPLAP	
ISLBES-338	2244	ISLBES-638	2395
ISLBES-344	2296	ISLBES-644	2449
ISLBES-350	2347	ISLBES-650	2503
DECORATIVE		DECORATIVE	
ISLBED-338	2262	ISLBED-638	2378
ISLBED-344	2321	ISLBED-644	2440
ISLBED-350	2386	ISLBED-650	2515

### DECORATIVE ONLY

WIDTH	# OF PANELS
26\" or Less	1
Over 26\" up to 45\"	2
Over 45\" up to 63\"	3
Over 63\" up to 84\"	4

## ISLAND "X" ENDS

- Finished All Sides
- For the Open Back X End, be sure to Specify Finished Ends on Island Cabinetry

### OPEN BACK

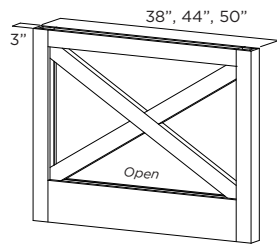

- ISLEXO (Front/Back)

### CLOSED BACK

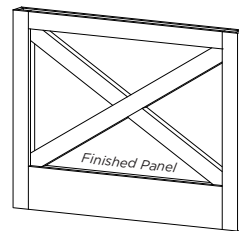

- ISLEX (Front)

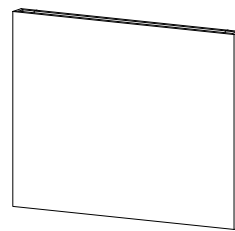

- ISLEX (Back)

3\" WIDE	PRICE
OPEN BACK	
ISLEXO-338	2532
ISLEXO-344	2575
ISLEXO-350	2618
CLOSED BACK	
ISLEX-338	2761
ISLEX-344	2821
ISLEX-350	2882

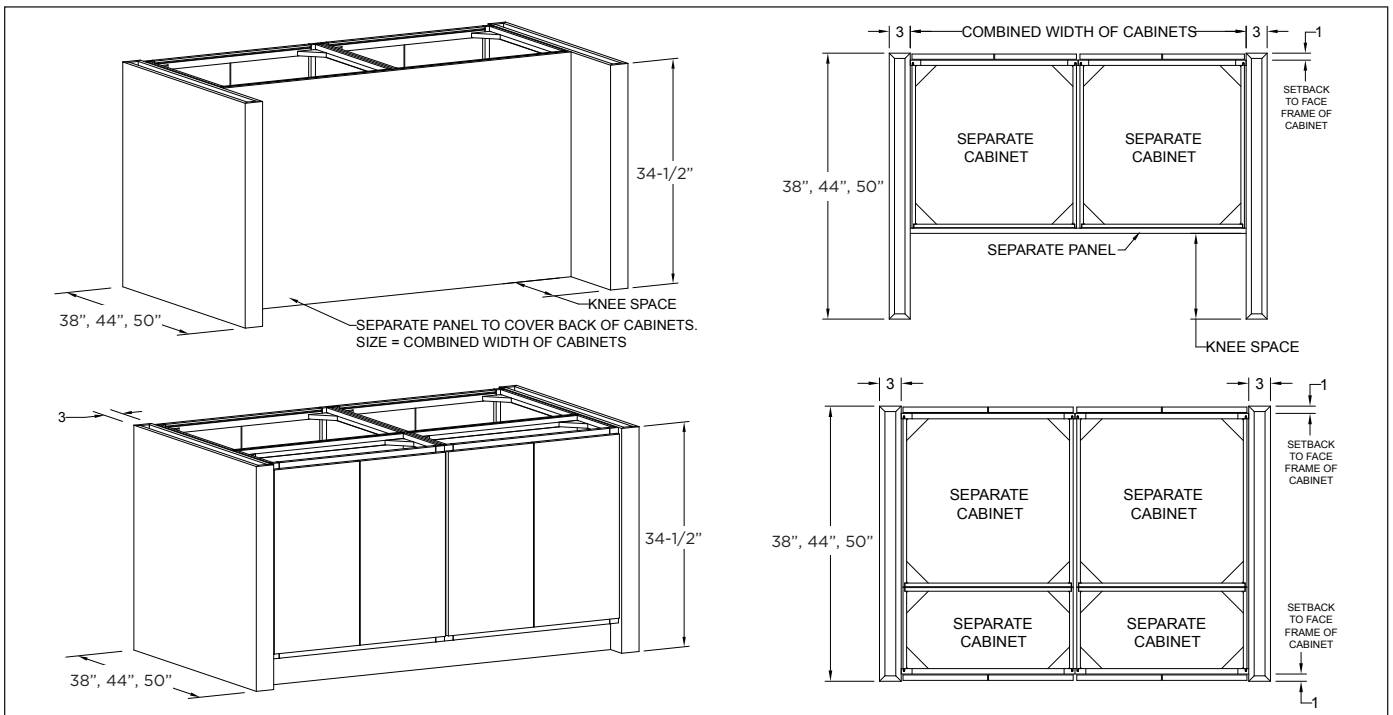

**DESIGN NOTE:** 6\" Architectural Post Option, side facing in will be blank.  
Only available in standard wood species.

# ELAN BASE ACCESSORIES

ALL ACCESSORIES CAN BE SPECIFIED WITH THE CABINET AND COME FACTORY INSTALLED.

## BREAD BOARD

- Finished to match. Front edge exposed matching in wood and finish
- Installed Above Top Drawer
- For Cabinets: 15", 18", 21", 24" Wide

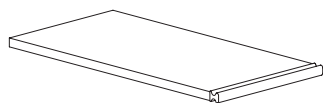

ITEM	PRICE
BB15	270
BB18	
BB21	
BB24	

## BASE CHOPPING BLOCK

- Hickory Natural
- Changes drawer to tip down with slide out chopping block
- For Cabinets: 18", 21", 24", 30" Wide

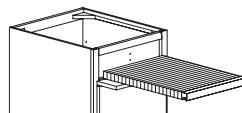

ITEM	PRICE
BCB18	693
BCB21	775
BCB24	859
BCB30	973

## KNIFE BLOCK

- Birch Natural
- For Cabinets: 15", 18", 21", 24" Wide

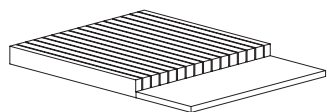

ITEM	PRICE
9 Knives	353
KB15	
13 Knives	
KB18	
15 Knives	
KB21	
19 Knives	
KB24	

## CUTTING BOARD DRAWER

- Wood cutting board with "funnel" through drawer box for easy use above a waste pull out.
- Available for 18" Wide Cabinet

ITEM	PRICE
ECBD18	560

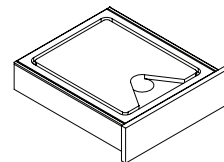

## CUTLERY DIVIDER

- Birch Natural
- Fixed in Drawer
- For Cabinets: 15", 18", 21", 24", 27", 30" 33" 36" Wide

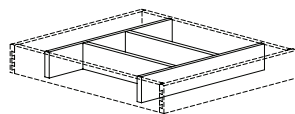

ITEM	INSTALLED	LOOSE
4 Dividers		
CD15	95	103
CD18		
5 Dividers		
CD21	95	103
6 Dividers		
CD24	95	103
CD27		
7 Dividers		
CD30	95	103
CD33		
8 Dividers		
CD36	95	103

## CUTLERY TRAY

- Birch Natural
- Stand Alone Unit
- Can be placed in a Roll Tray or Drawer box
- For Cabinets: 15", 18", 21", 24", 27", 30", 33" 36" Wide

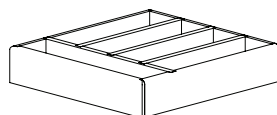

ITEM	PRICE
4 Dividers	
CT15	246
CT18	
5 Dividers	
CT21	246
6 Dividers	
CT24	246
7 Dividers	
CT27	369
8 Dividers	
CT30	369
9 Dividers	
CT33	369
10 Dividers	
CT36	369

## CUTLERY DIVIDER 2 TIER

- Birch Natural Dovetailed Box
- Top Tier is 1-1/2" High.
- Bottom Tier is 1-1/2" High
- For Cabinets: 15", 18", 21", 24" Wide

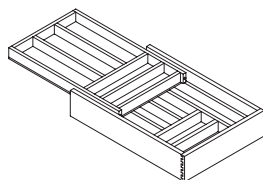

ITEM	PRICE
ECDDT15	697
ECDDT18	
ECDDT21	
ECDDT24	
MOD TO CAB	366

## SPICE DRAWER

- For Cabinets: 15", 18", 21", 24" Wide

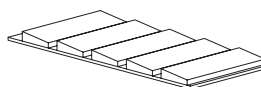

SIDE VIEW



ITEM	PRICE
SPDR15	493
SPDR18	
SPDR21	
SPDR24	

## CHARGING DRAWER

- Charging Drawer
- (2) 120V Plugs and (2) 2.1 amp USB Ports
- Power Cord with Nema 5-15 Plug
- Available for 18" wide cabinet.

ITEM	PRICE
ECHD18	1012

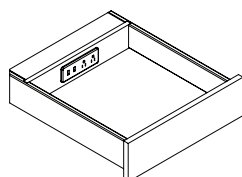

## DRAWER PARTITION (FIXED)

- Specify Number And Spacing
- Specify Horizontal or Vertical
- 5/8" thick, solid wood Partitions

ITEM	PRICE
DP	49

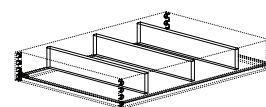

# ELAN BASE ACCESSORIES

ALL ACCESSORIES CAN BE SPECIFIED WITH THE CABINET AND COME FACTORY INSTALLED.

## DRAWER DIVIDER INSERT (ADJUSTABLE)

- Changes the Drawer Box to a Drawer Box with Adjustable Divider Inserts
- 5/8" thick, solid wood Partitions

### STYLE A

- 3 Adjustable/Removable Dividers
- Slots equally spaced

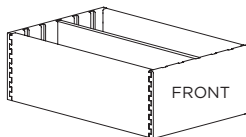

STYLE A	INSTALLED	BOX/GLIDES ONLY	BOX ONLY
3 Slots			
DDI-15A DDI-18A	159	511	370
5 Slots			
DDI-21A	159	511	370
DDI-24A DDI-27A DDI-30A	249	647	506
DDI-33A DDI-36A	344	741	600
6 Slots			
DDI-39A DDI-42A	475	848	712

### STYLE B

- 2 Adjustable/Removable Dividers
- Slots are equally spaced 2-3/4" apart

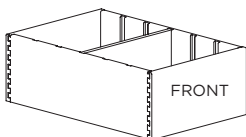

STYLE B	INSTALLED	BOX/GLIDES ONLY	BOX ONLY
5 Slots			
DDI-15B DDI-18B DDI-21B	159	511	370
DDI-24B DDI-27B DDI-30B	249	647	506
DDI-33B DDI-36B	344	741	600
DDI-39B DDI-42B	475	848	712

## DRAWER DIVIDER INSERT (EXTRA)

- Sold as Individual Partition
- Factory will Size Accordingly
- 5/8" thick, solid wood Partitions

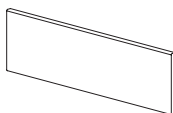

ITEM	PRICE
DDI	78

## LID STORAGE INSERT

- Stand Alone Unit
- Can be placed in a roll tray or drawer box
- 4-1/16" high x 19-5/8" deep

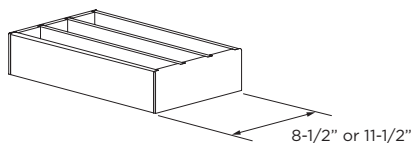

ITEM	PRICE
LSI-8.5	183
LSI-11.5	211

## DRAWER SLIDING TOP

- Specify which drawer is to have sliding top.

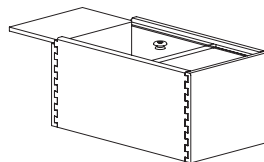

ITEM	PRICE
DST15	134
DST18	
DST21	
DST24	

## PEG BOARD DRAWER ORGANIZER

- Pegboard with 8 wooden dowels.
- Designed to fit in 24" deep cabinets.
- Additional dowels can be purchased in packages of four.
- Specify: PEG PACK
- Available 27", 30", 33", 36"

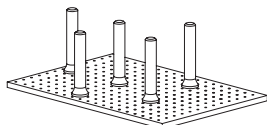

ITEM	PRICE
PBDO	259
PEG PACK	44

## SCOOPED DRAWER

- Designed To Provide Drawer Clearance Under Surface Mounted Cooktop

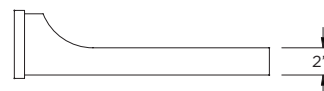

ITEM	PRICE
SD	34

# ELAN BASE ACCESSORIES

ALL ACCESSORIES CAN BE SPECIFIED WITH THE CABINET AND COME FACTORY INSTALLED.

## DRAWER FRONT BIN

- Plastic Bin
- Installed on tip down drawer front

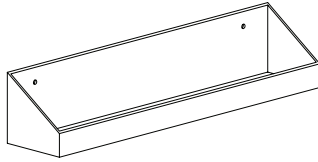

When shipped loose, tip down hardware not included.

ITEM	PRICE
DFB15	142
DFB18	
DFB21	
DFB24	
DFB27	
DFB30	
DFB33	
DFB36	

## UNDER SINK CADDY

- 11"W x 18-3/8"D x 19-1/2"H
- Removable caddy

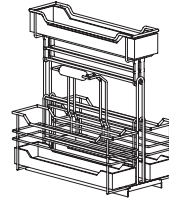

ITEM	PRICE
USC	704

## TRAY DIVIDERS

- 1/2" Thick
- Equally Spaced Removable Tray Dividers
- Specify Quantity
- Not Available with Angled Cabinets

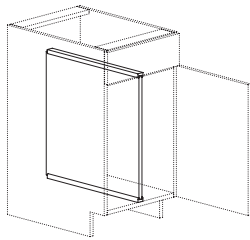

ITEM	PRICE
TD	138

## UNDERSINK PLUMBING PULL-OUT

- Functional Roll Tray with cut out for plumbing

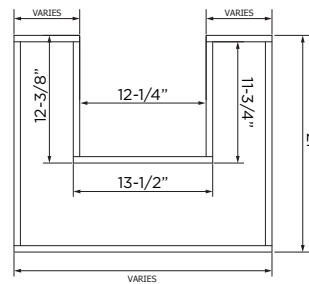

ITEM	PRICE
USPO27	401
USPO30	
USPO33	
USPO36	

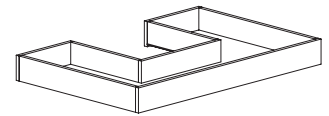

## TOE SPACE DRAWER

- Touch latch drawer in toe space
- Shipped loose or field installation in toe space

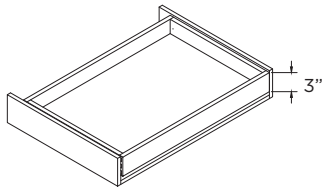

ITEM	PRICE
TSDWR15	417
TSDWR18	433
TSDWR21	450
TSDWR24	468
TSDWR27	454
TSDWR30	500
TSDWR33	519
TSDWR36	535
TSDWR39	552
TSDWR42	570

## BASE SINK DRIP TRAY

- Protects bottom of the sink base from spills.
- Fits a 27" or 30" sink base.

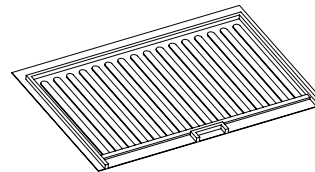

ITEM	PRICE
ESBDT27-30	111
ESBDT33-36	124
ESBDT39-42	136

## HIDDEN DRAWER

- Adds a 4" hidden drawer above an existing drawer box, behind the drawer front.

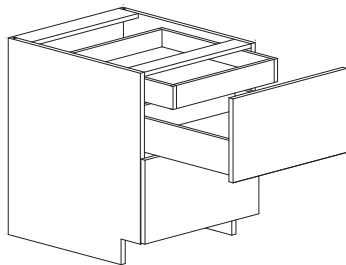

CABINET UP TO 24"W	CABINET OVER 24"W
331	377

## PAPER TOWEL DRAWER

- Available for top drawer only of cabinets with a standard top drawer
- Fixed shelf is installed below
- Entire paper towel area is finished to match exterior
- Sized for standard paper towel rolls (max. diameter 6-1/2")
- Removable dowel is accessible for refilling.
- Min. cabinet depth 24"

18", 21", 24"

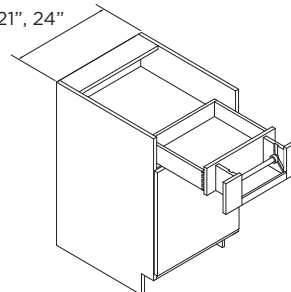

ITEM	PRICE
PTDWR	437

# ELAN BASE ACCESSORIES

ALL ACCESSORIES CAN BE SPECIFIED WITH THE CABINET AND COME FACTORY INSTALLED.

## DRAWER BOX(ES)

- Specify Cabinet Width and Depth (Factory will size accordingly)
- Includes Glides

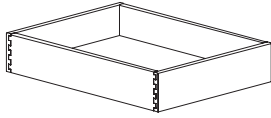

**Standard**  
4-1/16" High  
Dovetail Drawer

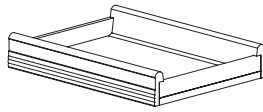

**Tandem Box**  
3-1/4" High  
Painted Gray Steel

ITEM	CABINET SIZE	STANDARD (S)	TANDEM (T)
DB15	15"	356	454
DB18	18"	356	454
DB21	21"	356	454
DB24	24"	356	454
DB27	27"	402	477
DB30	30"	402	477
DB33	33"	402	477
DB36	36"	402	477

## ROLL TRAYS

- Birch Natural Dovetailed Box
- Includes Full Extension Undermount Soft Motion Glides
- Specify Box, Standard or Tandem (S or T)
- Specify Quantity
- Max. Quantities:  
Standard Base: 3  
Base With FHD: 4

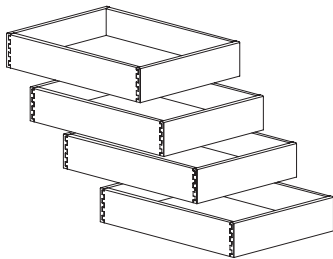

**Standard**  
3" High  
Dovetail Roll tray

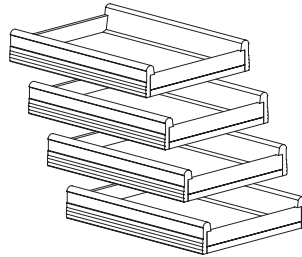

**Tandem Box**  
3-1/4" High  
Painted Gray Steel

ROLL TRAY HEIGHT	CABINET UP TO 24" WIDE	CABINET OVER 24" WIDE
3"	319	364
4"	331	377
5"	344	389
6"	356	401
7"	368	413
9"	392	438
12"	429	474

# ELAN BASE ACCESSORIES

ALL ACCESSORIES CAN BE SPECIFIED WITH THE CABINET AND COME FACTORY INSTALLED.

## TANDEM BOX CUTLERY DIVIDER

- Only Available with the Tandem Drawer Box

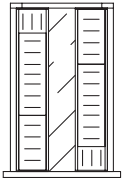

TCD15

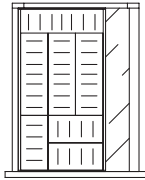

TCD18



TCD21

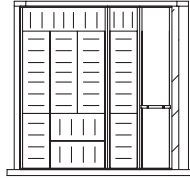

TCD24



TCD27

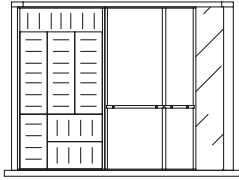

TCD30

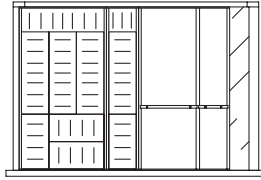

TCD33

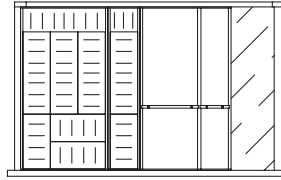

TCD36

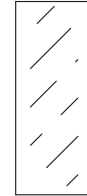

Drawer Box Bottom

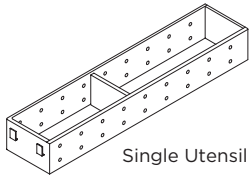

Single Utensil

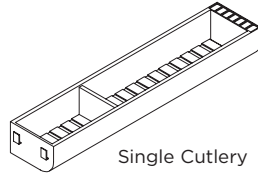

Single Cutlery

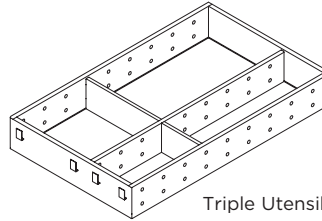

Triple Utensil

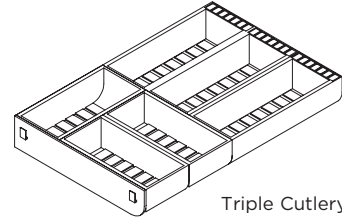

Triple Cutlery

ITEM	PRICE
TCD15	334
TCD18	281
TCD21	447
TCD24	537
TCD27	537
TCD30	498
TCD33	664
TCD36	664

	SINGLE CUTLERY	TRIPLE CUTLERY	SINGLE UTENSIL	TRIPLE UTENSIL
TCD15	2			
TCD18		1		
TCD21	1	1		
TCD24	1	1	1	
TCD27	1	1	1	
TCD30		1		1
TCD33	1	1		1
TCD36	1	1		1



**TABLE OF CONTENTS**

**ELAN TALL CABINETS ..... E800-1 thru E800-24**

Tall Broom Cabinets .....E800-2 thru E800-3  
Tall Utility Cabinets..... E800-4 thru E800-13  
Tall Pull-Out Storage..... E800-14  
Single Oven .....E800-15 thru E800-18  
Double Oven.....E800-19 thru E800-21  
Oven-Microwave .....E800-22  
Tall Microwave Cabinets.....E800-23 thru E800-24



# ELAN TALL CABINETS

## BROOM CABINETS

### 84", 90", 93" & 96" HIGH

- Subtoe is Shipped Attached Unless Specified "Ship Subtoe Loose"
- Shelves in Top Section only

### SINGLE DOOR

- Specify Hinge (L or R)
- 15"W - 24-1"W

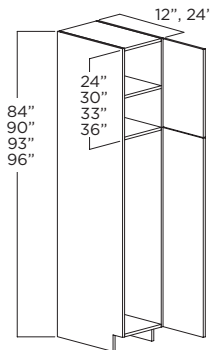

### BUTT DOORS

24-2"W - 36"W

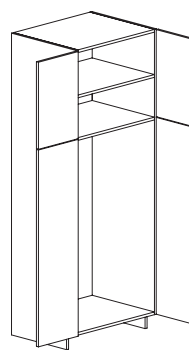

### DOUBLE DOORS

39"W - 42"W

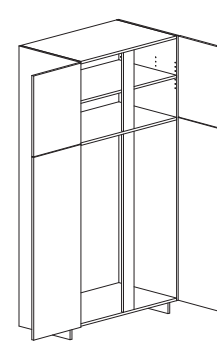

**DESIGN NOTES:** Height modifications affect the upper section only unless otherwise specified.

84" HIGH	A	B	C	D	E	F	G
<b>12" DEEP</b>	1 Adjustable Shelf						
EBR158412	1249	1311	1374	1436	1537	1599	1675
EBR188412	1286	1351	1416	1479	1582	1647	1724
EBR218412	1372	1440	1510	1578	1688	1757	1839
EBR248412-1	1433	1505	1577	1648	1763	1835	1921
EBR248412-2	1683	1768	1852	1936	2071	2155	2257
EBR278412	1781	1870	1960	2049	2192	2280	2388
EBR308412	1878	1972	2066	2160	2311	2405	2517
EBR338412	1963	2061	2160	2258	2416	2513	2632
EBR368412	2043	2145	2248	2350	2513	2615	2738
EBR398412	2127	2233	2340	2447	2619	2724	2851
EBR3428412	2214	2324	2436	2548	2724	2834	2966
<b>24" DEEP</b>	1 Adjustable Shelf						
EBR1584	1405	1474	1545	1616	1729	1798	1883
EBR1884	1490	1565	1639	1714	1834	1908	1998
EBR2184	1588	1667	1747	1826	1954	2033	2128
EBR2484-1	1659	1742	1825	1908	2042	2123	2224
EBR2484-2	1949	2046	2144	2242	2397	2495	2611
EBR2784	2064	2166	2270	2374	2539	2642	2765
EBR3084	2175	2284	2392	2501	2676	2785	2914
EBR3384	2274	2388	2501	2615	2797	2911	3048
EBR3684	2366	2484	2603	2721	2911	3028	3170
EBR3984	2460	2583	2707	2831	3028	3149	3299
EBR4284	2561	2687	2816	2945	3149	3278	3431

90" HIGH	A	B	C	D	E	F	G
<b>12" DEEP</b>	1 Adjustable Shelf						
EBR159012	1331	1397	1465	1532	1638	1704	1785
EBR189012	1405	1474	1545	1616	1729	1798	1883
EBR219012	1487	1561	1636	1710	1829	1903	1993
EBR249012-1	1548	1625	1703	1780	1905	1982	2075
EBR249012-2	1795	1884	1974	2065	2208	2298	2406
EBR279012	1892	1987	2082	2177	2329	2423	2537
EBR309012	1988	2087	2187	2286	2445	2545	2664
EBR339012	2071	2175	2279	2383	2548	2652	2775
EBR369012	2150	2258	2366	2473	2645	2753	2883
EBR399012	2232	2344	2456	2569	2747	2859	2991
EBR249012	2317	2433	2550	2666	2851	2968	3107
<b>24" DEEP</b>	1 Adjustable Shelf						
EBR1590	1539	1616	1693	1770	1894	1971	2064
EBR1890	1625	1705	1787	1869	1999	2081	2177
EBR2190	1721	1807	1894	1980	2117	2204	2307
EBR2490-1	1791	1880	1971	2060	2203	2293	2401
EBR2490-2	2076	2180	2284	2388	2554	2658	2782
EBR2790	2188	2298	2407	2517	2692	2802	2933
EBR3090	2300	2414	2531	2645	2829	2944	3082
EBR3390	2396	2516	2636	2756	2947	3067	3212
EBR3690	2487	2611	2736	2861	3059	3183	3333
EBR3990	2581	2710	2840	2970	3176	3304	3461
EBR4290	2679	2813	2948	3083	3297	3429	3592

93" HIGH	A	B	C	D	E	F	G
<b>12" DEEP</b>	1 Adjustable Shelf						
EBR159312	1402	1472	1543	1614	1725	1796	1879
EBR189312	1472	1545	1620	1693	1811	1885	1973
EBR219312	1553	1630	1708	1786	1911	1988	2081
EBR249312-1	1609	1689	1770	1851	1979	2060	2156
EBR249312-2	1846	1938	2031	2123	2271	2363	2474
EBR279312	1939	2035	2133	2230	2385	2483	2599
EBR309312	2029	2131	2232	2334	2496	2598	2720
EBR339312	2110	2215	2322	2427	2595	2702	2828
EBR369312	2186	2295	2405	2515	2690	2798	2929
EBR399312	2264	2378	2494	2606	2787	2901	3036
EBR429312	2348	2463	2581	2700	2889	3005	3146
<b>24" DEEP</b>	1 Adjustable Shelf						
EBR1593	1622	1703	1785	1867	1996	2077	2175
EBR1893	1703	1789	1874	1958	2095	2181	2282
EBR2193	1797	1886	1977	2067	2212	2301	2408
EBR2493-1	1863	1956	2050	2143	2292	2385	2498
EBR2493-2	2137	2243	2351	2458	2630	2736	2864
EBR2793	2243	2356	2468	2581	2760	2872	3006
EBR3093	2350	2467	2586	2703	2891	3009	3149
EBR3393	2441	2564	2686	2808	3004	3126	3271
EBR3693	2531	2656	2784	2911	3114	3240	3391
EBR3993	2621	2752	2884	3013	3225	3354	3511
EBR4293	2718	2851	2988	3124	3344	3478	3640

96" HIGH	A	B	C	D	E	F	G
<b>12" DEEP</b>	2 Adjustable Shelves						
EBR159612	1474	1548	1622	1696	1814	1888	1977
EBR189612	1542	1619	1697	1774	1897	1974	2066
EBR219612	1619	1699	1781	1862	1991	2072	2170
EBR249612-1	1674	1757	1841	1925	2059	2143	2243
EBR249612-2	1901	1996	2092	2187	2339	2434	2548
EBR279612	1990	2089	2189	2290	2449	2548	2667
EBR309612	2078	2182	2286	2390	2556	2660	2785
EBR339612	2155	2263	2372	2479	2652	2759	2889
EBR369612	2227	2339	2451	2562	2741	2852	2985
EBR399612	2303	2419	2535	2651	2835	2948	3088
EBR429612	2382	2501	2621	2738	2931	3048	3191
<b>24" DEEP</b>	2 Adjustable Shelves						
EBR1596	1704	1790	1875	1961	2097	2182	2284
EBR1896	1782	1872	1961	2050	2193	2282	2389
EBR2196	1870	1965	2057	2152	2301	2395	2507
EBR2496-1	1934	2031	2128	2225	2379	2476	2592
EBR2496-2	2197	2307	2417	2527	2703	2813	2944
EBR2796	2301	2416	2532	2647	2830	2945	3083
EBR3096	2402	2522	2643	2763	2955	3076	3220
EBR3396	2491	2616	2741	2866	3065	3190	3339
EBR3696	2576	2704	2834	2963	3169	3297	3452
EBR3996	2663	2796	2930	3064	3277	3411	3570
EBR4296	2756	2891	3030	3169	3388	3524	3689



# ELAN TALL CABINETS

## BROOM CABINETS 102", 108" & 120" HIGH

- Subtoe is Shipped Attached Unless Specified "Ship Subtoe Loose"
- Shelves in Top Section only
- Cabinets over 96" high with Finished Side or Finished Interior, not available in Foil.

### SINGLE DOOR

- Specify Hinge (L or R)
- 15"W - 24-1"W

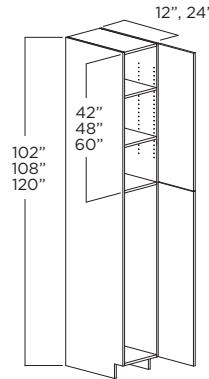

### BUTT DOORS

24-2"W - 36"W

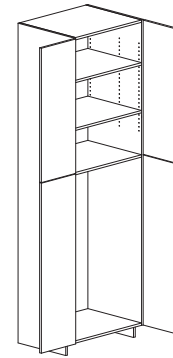

### DOUBLE DOORS

39"W - 42"W

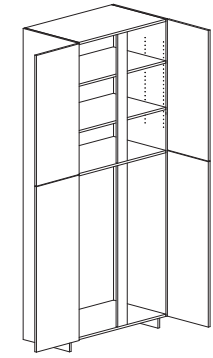

**DESIGN NOTES:** Height modifications affect the upper section, only unless otherwise specified.

102" HIGH	A	B	C	D	E	F	G
<b>12" DEEP</b>	2 Adjustable Shelves						
EBR1510212	1634	1715	1798	1880	2012	2093	2190
EBR1810212	1709	1794	1880	1966	2103	2187	2289
EBR2110212	1794	1882	1972	2063	2206	2294	2401
EBR2410212-1	1855	1948	2041	2135	2283	2374	2485
EBR2410212-2	2107	2213	2319	2425	2593	2697	2823
EBR2710212	2206	2315	2426	2537	2713	2821	2953
EBR3010212	2304	2419	2535	2651	2835	2948	3086
EBR3310212	2389	2508	2629	2749	2940	3058	3200
EBR3610212	2468	2593	2718	2842	3040	3161	3309
EBR3910212	2556	2684	2813	2942	3146	3272	3428
EBR4210212	2643	2776	2909	3039	3253	3383	3542
<b>24" DEEP</b>	2 Adjustable Shelves						
EBR15102	1889	1983	2079	2174	2324	2418	2531
EBR18102	1976	2075	2174	2272	2431	2529	2647
EBR21102	2075	2178	2281	2385	2551	2653	2777
EBR24102-1	2143	2250	2358	2466	2637	2743	2873
EBR24102-2	2434	2556	2679	2802	2996	3119	3262
EBR27102	2551	2679	2807	2933	3137	3263	3416
EBR30102	2661	2794	2928	3062	3275	3409	3568
EBR33102	2762	2900	3037	3176	3396	3535	3701
EBR36102	2853	2996	3140	3284	3511	3655	3826
EBR39102	2953	3101	3250	3398	3634	3783	3960
EBR42102	3056	3206	3360	3514	3758	3908	4091

108" HIGH	A	B	C	D	E	F	G
<b>12" DEEP</b>	2 Adjustable Shelves						
EBR1510812	1810	1900	1992	2083	2229	2319	2427
EBR1810812	1893	1988	2083	2179	2330	2423	2536
EBR2110812	1988	2085	2185	2285	2444	2542	2661
EBR2410812-1	2055	2158	2262	2365	2529	2631	2754
EBR2410812-2	2335	2452	2569	2687	2873	2989	3128
EBR2710812	2445	2565	2688	2811	3006	3126	3272
EBR3010812	2552	2680	2809	2937	3141	3267	3420
EBR3310812	2647	2779	2912	3046	3257	3388	3546
EBR3610812	2734	2874	3012	3149	3368	3503	3667
EBR3910812	2833	2974	3117	3260	3486	3625	3798
EBR4210812	2929	3075	3223	3367	3604	3749	3924
<b>24" DEEP</b>	2 Adjustable Shelves						
EBR15108	2093	2198	2303	2408	2575	2679	2804
EBR18108	2189	2299	2409	2517	2694	2802	2933
EBR21108	2299	2414	2527	2643	2826	2940	3077
EBR24108-1	2374	2493	2613	2733	2922	3039	3184
EBR24108-2	2697	2832	2968	3104	3319	3455	3614
EBR27108	2827	2968	3111	3250	3476	3615	3784
EBR30108	2948	3096	3244	3393	3628	3777	3953
EBR33108	3060	3213	3365	3519	3763	3917	4100
EBR36108	3161	3320	3479	3638	3890	4050	4239
EBR39108	3272	3436	3601	3766	4027	4192	4387
EBR42108	3387	3553	3723	3894	4164	4331	4533

120" HIGH	A	B	C	D	E	F	G
<b>12" DEEP</b>	3 Adjustable Shelves						
EBR1512012	2210	2321	2432	2544	2722	2832	2964
EBR1812012	2312	2428	2544	2661	2845	2959	3098
EBR2112012	2428	2547	2669	2791	2985	3104	3250
EBR2412012-1	2510	2636	2762	2889	3089	3213	3363
EBR2412012-2	2852	2994	3138	3282	3509	3650	3821
EBR2712012	2986	3132	3282	3433	3671	3818	3996
EBR3012012	3117	3273	3430	3587	3836	3990	4176
EBR3312012	3232	3394	3557	3720	3978	4137	4331
EBR3612012	3339	3509	3678	3846	4113	4278	4478
EBR3912012	3459	3632	3807	3981	4257	4428	4638
EBR4212012	3577	3756	3936	4113	4402	4578	4792
<b>24" DEEP</b>	3 Adjustable Shelves						
EBR15120	2554	2682	2811	2940	3144	3270	3422
EBR18120	2672	2806	2940	3072	3288	3420	3580
EBR21120	2806	2946	3084	3226	3450	3588	3756
EBR24120-1	2898	3043	3189	3335	3566	3709	3886
EBR24120-2	3292	3457	3623	3789	4051	4217	4411
EBR27120	3450	3623	3797	3967	4242	4413	4619
EBR30120	3599	3779	3960	4141	4429	4610	4825
EBR33120	3735	3922	4107	4295	4593	4781	5005
EBR36120	3859	4052	4246	4441	4749	4943	5174
EBR39120	3994	4193	4395	4596	4915	5116	5355
EBR42120	4133	4336	4544	4752	5082	5286	5533

# ELAN TALL CABINETS

## UTILITY CABINET - STYLE A 84", 90", 93" & 96" HIGH

- Subtoe is Shipped Attached Unless Specified  
"Ship Subtoe Loose"

### SINGLE DOOR

- Specify Hinge (L or R)
- 15"W - 24-1"W

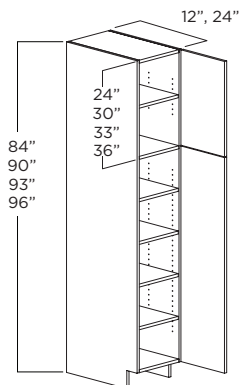

### BUTT DOORS

24-2"W - 36"W

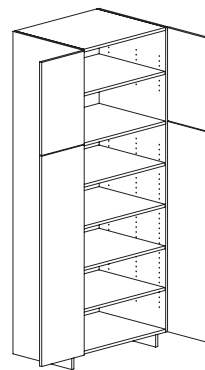

### DOUBLE DOORS

39"W - 42"W

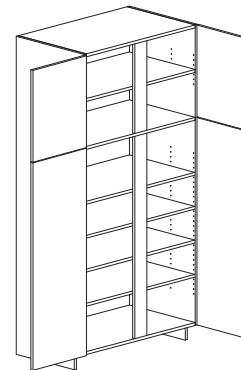

**DESIGN NOTES:** Height modifications affect the upper section only unless otherwise specified.

84" HIGH	A	B	C	D	E	F	G
<b>12" DEEP</b>	5 Adjustable Shelves (1 Upper, 4 Lower)						
EUT158412A	1392	1462	1532	1601	1713	1782	1867
EUT188412A	1501	1576	1652	1727	1847	1922	2012
EUT218412A	1612	1693	1774	1855	1984	2065	2161
EUT248412A-1	1724	1811	1896	1983	2121	2207	2311
EUT248412A-2	1957	2055	2154	2252	2408	2506	2623
EUT278412A	2093	2198	2303	2407	2575	2680	2806
EUT308412A	2234	2345	2457	2570	2748	2859	2994
EUT338412A	2378	2496	2616	2735	2925	3044	3187
EUT368412A	2489	2614	2738	2863	3062	3187	3336
EUT398412A	2612	2739	2871	3002	3211	3342	3498
EUT428412A	2732	2871	3006	3144	3362	3500	3663
<b>24" DEEP</b>	5 Adjustable Shelves (1 Upper, 4 Lower)						
EUT1584A	1692	1776	1862	1946	2082	2166	2268
EUT1884A	1823	1914	2006	2097	2242	2334	2443
EUT2184A	1960	2057	2156	2254	2411	2509	2627
EUT2484A-1	2095	2201	2306	2411	2578	2682	2808
EUT2484A-2	2377	2495	2615	2734	2924	3043	3185
EUT2784A	2543	2670	2797	2924	3128	3256	3408
EUT3084A	2712	2847	2983	3119	3336	3472	3634
EUT3384A	2889	3033	3179	3323	3554	3698	3872
EUT3684A	3023	3175	3326	3477	3719	3870	4051
EUT3984A	3166	3324	3484	3643	3896	4056	4245
EUT4284A	3315	3480	3648	3811	4076	4243	4441

90" HIGH	A	B	C	D	E	F	G
<b>12" DEEP</b>	5 Adjustable Shelves (1 Upper, 4 Lower)						
EUT159012A	1524	1600	1677	1754	1875	1952	2043
EUT189012A	1631	1713	1795	1877	2006	2088	2186
EUT219012A	1745	1831	1919	2007	2147	2234	2339
EUT249012A-1	1856	1949	2042	2134	2284	2377	2488
EUT249012A-2	2089	2193	2298	2403	2571	2675	2801
EUT279012A	2226	2337	2450	2561	2738	2850	2984
EUT309012A	2364	2483	2601	2720	2908	3027	3169
EUT339012A	2511	2637	2763	2889	3089	3215	3366
EUT369012A	2622	2753	2885	3016	3226	3357	3515
EUT399012A	2737	2874	3012	3150	3368	3504	3670
EUT429012A	2858	3001	3145	3289	3517	3661	3832
<b>24" DEEP</b>	5 Adjustable Shelves (1 Upper, 4 Lower)						
EUT1590A	1851	1944	2037	2130	2278	2369	2480
EUT1890A	1983	2082	2182	2281	2440	2539	2658
EUT2190A	2120	2226	2333	2439	2608	2714	2841
EUT2490A-1	2256	2368	2482	2594	2775	2888	3023
EUT2490A-2	2538	2665	2792	2919	3122	3249	3401
EUT2790A	2704	2840	2976	3110	3326	3462	3625
EUT3090A	2873	3017	3160	3304	3534	3677	3850
EUT3390A	3051	3204	3357	3510	3754	3906	4089
EUT3690A	3186	3345	3505	3664	3919	4078	4270
EUT3990A	3326	3492	3660	3827	4093	4257	4460
EUT4290A	3472	3646	3821	3996	4273	4444	4656

93" HIGH	A	B	C	D	E	F	G
<b>12" DEEP</b>	5 Adjustable Shelves (1 Upper, 4 Lower)						
EUT159312A	1603	1683	1764	1844	1972	2053	2148
EUT189312A	1709	1795	1880	1966	2103	2188	2291
EUT219312A	1818	1908	2000	2092	2237	2328	2436
EUT249312A-1	1927	2023	2120	2216	2370	2467	2582
EUT249312A-2	2152	2259	2367	2474	2647	2754	2884
EUT279312A	2285	2399	2513	2628	2811	2925	3062
EUT309312A	2421	2542	2663	2784	2978	3099	3245
EUT339312A	2562	2691	2819	2947	3153	3280	3434
EUT369312A	2671	2804	2939	3072	3286	3419	3579
EUT399312A	2783	2922	3062	3199	3424	3562	3728
EUT429312A	2902	3044	3191	3337	3568	3714	3888
<b>24" DEEP</b>	5 Adjustable Shelves (1 Upper, 4 Lower)						
EUT1593A	1947	2045	2143	2240	2396	2494	2610
EUT1893A	2076	2180	2284	2388	2554	2658	2782
EUT2193A	2209	2319	2430	2542	2718	2828	2961
EUT2493A-1	2341	2458	2576	2693	2880	2998	3138
EUT2493A-2	2615	2746	2877	3007	3216	3347	3505
EUT2793A	2776	2916	3055	3193	3416	3554	3721
EUT3093A	2943	3089	3237	3385	3620	3767	3944
EUT3393A	3114	3269	3425	3582	3830	3987	4172
EUT3693A	3245	3407	3570	3732	3991	4154	4348
EUT3993A	3388	3554	3724	3895	4165	4335	4538
EUT4293A	3530	3706	3880	4058	4340	4518	4729

96" HIGH	A	B	C	D	E	F	G
<b>12" DEEP</b>	6 Adjustable Shelves (2 Upper, 4 Lower)						
EUT159612A	1670	1753	1837	1921	2055	2138	2238
EUT189612A	1771	1859	1949	2038	2180	2268	2374
EUT219612A	1877	1971	2065	2159	2309	2402	2515
EUT249612A-1	1982	2081	2181	2280	2438	2537	2656
EUT249612A-2	2201	2311	2421	2531	2707	2817	2949
EUT279612A	2329	2445	2562	2678	2866	2982	3121
EUT309612A	2460	2583	2707	2829	3026	3149	3297
EUT339612A	2598	2727	2858	2988	3196	3325	3482
EUT369612A	2702	2836	2972	3108	3324	3458	3621
EUT399612A	2812	2949	3091	3233	3457	3598	3766
EUT429612A	2924	3067	3215	3362	3595	3742	3917
<b>24" DEEP</b>	6 Adjustable Shelves (2 Upper, 4 Lower)						
EUT1596A	2043	2145	2248	2350	2513	2615	2738
EUT1896A	2167	2276	2385	2493	2666	2775	2905
EUT2196A	2297	2412	2527	2642	2826	2941	3078
EUT2496A-1	2425	2546	2669	2790	2984	3105	3251
EUT2496A-2	2693	2828	2963	3098	3313	3447	3610
EUT2796A	2850	2993	3136	3278	3506	3648	3819
EUT3096A	3011	3161	3313	3463	3704	3855	4035
EUT3396A	3179	3337	3496	3655	3910	4068	4259
EUT3696A	3306	3471	3637	3802	4066	4232	4430
EUT3996A	3445	3613	3787	3960	4235	4405	4614
EUT4296A	3582	3761	3938	4119	4405	4585	4800

# ELAN TALL CABINETS

## UTILITY CABINET - STYLE A 102", 108" & 120" HIGH

- Subtoe is Shipped Attached Unless Specified "Ship Subtoe Loose"
- Cabinets over 96" high with Finished Side or Finished Interior, not available in Foil.

### SINGLE DOOR

- Specify Hinge (L or R)
- 15"W - 24-1"W

### BUTT DOORS

24-2"W - 36"W

### DOUBLE DOORS

39"W - 42"W

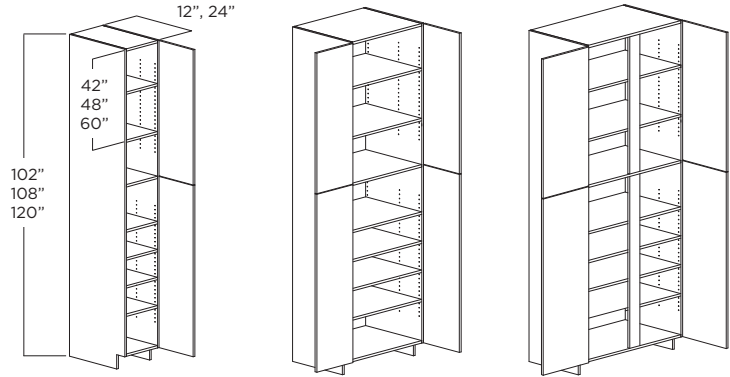

**DESIGN NOTES:** Height modifications affect the upper section only unless otherwise specified.

102" HIGH	A	B	C	D	E	F	G
<b>12" DEEP</b>	6 Adjustable Shelves (2 Upper, 4 Lower)						
EUT1510212A	1830	1921	2014	2106	2254	2344	2453
EUT1810212A	1941	2038	2136	2234	2389	2487	2603
EUT2110212A	2058	2161	2265	2366	2530	2634	2757
EUT2410212A-1	2173	2282	2391	2499	2672	2782	2912
EUT2410212A-2	2412	2533	2654	2776	2968	3087	3232
EUT2710212A	2552	2680	2808	2937	3141	3269	3422
EUT3010212A	2698	2832	2968	3102	3317	3453	3614
EUT3310212A	2849	2991	3135	3275	3503	3646	3817
EUT3610212A	2963	3108	3257	3406	3645	3791	3969
EUT3910212A	3081	3232	3387	3542	3788	3943	4127
EUT4210212A	3204	3361	3523	3684	3939	4101	4292
<b>24" DEEP</b>	6 Adjustable Shelves (2 Upper, 4 Lower)						
EUT15102A	2240	2352	2465	2577	2756	2867	3003
EUT18102A	2376	2495	2615	2735	2924	3044	3186
EUT21102A	2519	2645	2772	2896	3100	3224	3375
EUT24102A-1	2660	2793	2927	3058	3273	3405	3564
EUT24102A-2	2953	3100	3249	3398	3633	3779	3959
EUT27102A	3127	3283	3441	3595	3844	4002	4189
EUT30102A	3302	3467	3633	3796	4063	4226	4424
EUT33102A	3487	3661	3833	4009	4287	4463	4672
EUT36102A	3626	3807	3990	4169	4459	4641	4858
EUT39102A	3778	3964	4154	4344	4645	4832	5062
EUT42102A	3930	4126	4320	4518	4832	5030	5265

108" HIGH	A	B	C	D	E	F	G
<b>12" DEEP</b>	6 Adjustable Shelves (2 Upper, 4 Lower)						
EUT1510812A	2005	2106	2207	2308	2470	2569	2689
EUT1810812A	2128	2234	2341	2449	2618	2726	2853
EUT2110812A	2255	2368	2482	2593	2773	2887	3022
EUT2410812A-1	2382	2501	2621	2738	2928	3049	3191
EUT2410812A-2	2644	2776	2909	3042	3253	3384	3542
EUT2710812A	2797	2937	3078	3219	3442	3583	3750
EUT3010812A	2957	3104	3253	3399	3635	3784	3961
EUT3310812A	3122	3278	3436	3590	3839	3996	4183
EUT3610812A	3247	3406	3570	3733	3995	4155	4350
EUT3910812A	3377	3542	3712	3882	4152	4322	4524
EUT4210812A	3512	3684	3861	4038	4318	4494	4704
<b>24" DEEP</b>	6 Adjustable Shelves (2 Upper, 4 Lower)						
EUT15108A	2455	2577	2701	2825	3021	3142	3291
EUT18108A	2604	2735	2866	2997	3205	3336	3492
EUT21108A	2761	2899	3038	3174	3397	3534	3699
EUT24108A-1	2915	3061	3208	3352	3588	3731	3906
EUT24108A-2	3236	3398	3561	3724	3982	4142	4339
EUT27108A	3427	3598	3771	3940	4214	4386	4591
EUT30108A	3619	3800	3982	4161	4453	4632	4848
EUT33108A	3821	4013	4201	4394	4699	4891	5120
EUT36108A	3974	4173	4373	4569	4887	5087	5325
EUT39108A	4141	4344	4553	4761	5091	5295	5547
EUT42108A	4307	4522	4735	4952	5296	5513	5770

120" HIGH	A	B	C	D	E	F	G
<b>12" DEEP</b>	7 Adjustable Shelves (3 Upper, 4 Lower)						
EUT1512012A	2400	2520	2641	2762	2956	3074	3218
EUT1812012A	2546	2674	2802	2930	3134	3262	3414
EUT2112012A	2699	2834	2970	3103	3319	3455	3616
EUT2412012A-1	2850	2993	3137	3277	3505	3648	3819
EUT2412012A-2	3164	3322	3482	3641	3894	4050	4239
EUT2712012A	3347	3515	3684	3852	4119	4288	4488
EUT3012012A	3538	3715	3893	4068	4350	4529	4741
EUT3312012A	3736	3923	4111	4296	4594	4782	5006
EUT3612012A	3886	4076	4272	4468	4781	4973	5205
EUT3912012A	4041	4239	4443	4646	4968	5172	5414
EUT4212012A	4203	4409	4620	4832	5167	5379	5630
<b>24" DEEP</b>	7 Adjustable Shelves (3 Upper, 4 Lower)						
EUT15120A	2938	3085	3233	3381	3615	3760	3939
EUT18120A	3117	3273	3430	3587	3836	3993	4179
EUT21120A	3304	3469	3636	3799	4066	4229	4426
EUT24120A-1	3489	3663	3839	4011	4293	4466	4674
EUT24120A-2	3873	4066	4261	4457	4766	4957	5193
EUT27120A	4101	4306	4513	4715	5043	5249	5495
EUT30120A	4331	4547	4766	4979	5329	5543	5802
EUT33120A	4573	4802	5028	5258	5623	5854	6127
EUT36120A	4756	4994	5234	5468	5848	6088	6372
EUT39120A	4956	5199	5448	5698	6093	6337	6639
EUT42120A	5154	5412	5666	5926	6337	6597	6906

# ELAN TALL CABINETS

## UTILITY CABINET - STYLE B

### 84", 90", 93" & 96" HIGH

- Subtoe is Shipped Attached Unless Specified "Ship Subtoe Loose"
- Roll trays are 3" high, dovetailed with undermount, full extension, soft close glides.

### SINGLE DOOR

- Specify Hinge (L or R)
- 15"W - 24-1"W

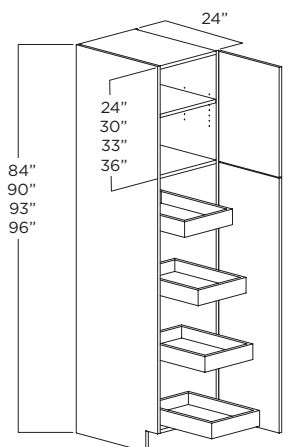

### BUTT DOORS

24-2"W - 36"W

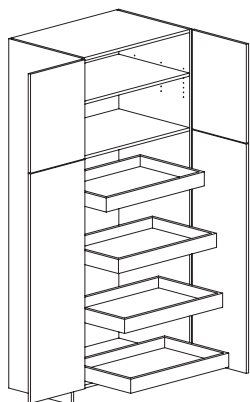

### DOUBLE DOORS

- 8 Roll Trays
- 39"W - 42"W

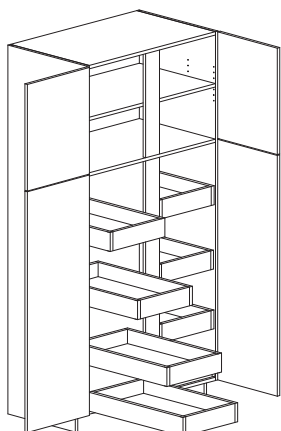

84" HIGH	A	B	C	D	E	F	G
<b>24" DEEP</b>	1 Adjustable Shelf, 4 Adjustable Roll Trays						
EUT1584B	2443	2555	2667	2780	2960	3072	3207
EUT1884B	2604	2724	2845	2966	3159	3279	3423
EUT2184B	2767	2895	3024	3153	3358	3487	3642
EUT2484B-1	2929	3066	3203	3340	3559	3696	3859
EUT2484B-2	3212	3362	3513	3665	3906	4056	4237
EUT2784B	3403	3564	3725	3885	4142	4302	4495
EUT3084B	3594	3764	3934	4104	4377	4546	4751
EUT3384B	3767	3945	4125	4303	4588	4767	4982
EUT3684B	3943	4130	4318	4505	4804	4993	5218
EUT3984B	4130	4324	4523	4718	5029	5228	5461
EUT4284B	4324	4527	4736	4939	5265	5474	5723

90" HIGH	A	B	C	D	E	F	G
<b>24" DEEP</b>	1 Adjustable Shelf, 4 Adjustable Roll Trays						
EUT1590B	2604	2725	2845	2966	3159	3279	3423
EUT1890B	2765	2894	3023	3152	3357	3485	3639
EUT2190B	2928	3065	3202	3339	3557	3693	3857
EUT2490B-1	3093	3237	3383	3528	3760	3905	4078
EUT2490B-2	3373	3532	3691	3850	4104	4263	4454
EUT2790B	3562	3731	3900	4068	4337	4506	4708
EUT3090B	3754	3933	4111	4289	4573	4752	4965
EUT3390B	3928	4115	4302	4488	4787	4973	5198
EUT3690B	4101	4297	4493	4688	5000	5196	5430
EUT3990B	4289	4490	4697	4899	5227	5429	5676
EUT4290B	4478	4692	4904	5119	5457	5673	5927

93" HIGH	A	B	C	D	E	F	G
<b>24" DEEP</b>	1 Adjustable Shelf, 4 Adjustable Roll Trays						
EUT1593B	2702	2828	2952	3078	3279	3403	3554
EUT1893B	2857	2990	3123	3257	3469	3603	3763
EUT2193B	3017	3158	3300	3441	3666	3808	3977
EUT2493B-1	3175	3324	3473	3622	3861	4010	4188
EUT2493B-2	3449	3611	3775	3938	4198	4361	4555
EUT2793B	3634	3807	3979	4150	4425	4598	4804
EUT3093B	3822	4002	4185	4366	4657	4837	5055
EUT3393B	3989	4179	4369	4559	4862	5051	5280
EUT3693B	4159	4357	4556	4754	5071	5269	5507
EUT3993B	4332	4544	4753	4958	5290	5494	5744
EUT4293B	4514	4740	4958	5171	5517	5730	5991

96" HIGH	A	B	C	D	E	F	G
<b>24" DEEP</b>	2 Adjustable Shelves, 4 Adjustable Roll Trays						
EUT1596B	2798	2928	3059	3190	3397	3528	3683
EUT1896B	2950	3088	3226	3363	3584	3721	3888
EUT2196B	3105	3251	3396	3542	3775	3921	4095
EUT2496B-1	3260	3413	3567	3721	3966	4119	4303
EUT2496B-2	3528	3694	3862	4028	4295	4462	4661
EUT2796B	3708	3884	4060	4235	4516	4692	4902
EUT3096B	3890	4075	4260	4445	4741	4925	5147
EUT3396B	4054	4247	4440	4633	4941	5135	5367
EUT3696B	4219	4421	4622	4823	5144	5346	5587
EUT3996B	4396	4602	4814	5021	5357	5564	5817
EUT4296B	4572	4791	5011	5227	5577	5797	6056

**DESIGN NOTES:** Height modifications affect the upper section only unless otherwise specified.

## UTILITY CABINET - STYLE B 102", 108" & 120" HIGH

- Subtoe is Shipped Attached Unless Specified "Ship Subtoe Loose"
- Cabinets over 96" high with Finished Side or Finished Interior, not available in Foil.
- Roll trays are 3" high, dovetailed with undermount, full extension, soft close glides.

### SINGLE DOOR

- Specify Hinge (L or R)
- 15"W - 24-1"W

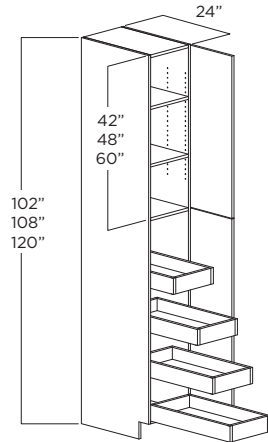

### BUTT DOORS 24-2"W - 36"W

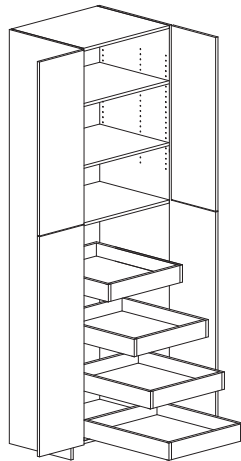

### DOUBLE DOORS

- 8 Roll Trays
- 39"W - 42"W

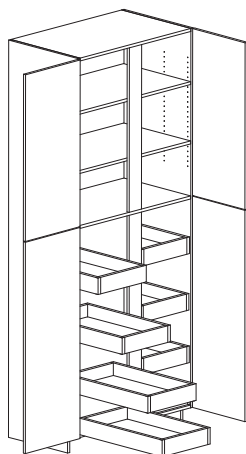

102" HIGH	A	B	C	D	E	F	G
<b>24" DEEP</b>	2 Adjustable Shelves, 4 Adjustable Roll Trays						
EUT15102B	2897	3030	3167	3303	3518	3652	3812
EUT18102B	3054	3197	3341	3498	3712	3853	4025
EUT21102B	3215	3367	3515	3666	3909	4060	4239
EUT24102B-1	3376	3535	3694	3853	4108	4263	4454
EUT24102B-2	3653	3825	3997	4169	4448	4620	4827
EUT27102B	3839	4020	4205	4386	4675	4856	5073
EUT30102B	4028	4221	4411	4601	4909	5099	5327
EUT33102B	4201	4398	4600	4798	5119	5317	5559
EUT36102B	4369	4578	4789	4995	5329	5540	5787
EUT39102B	4552	4766	4985	5200	5548	5762	6024
EUT42102B	4734	4962	5190	5413	5775	6004	6271

108" HIGH	A	B	C	D	E	F	G
<b>24" DEEP</b>	2 Adjustable Shelves, 4 Adjustable Roll Trays						
EUT15108B	2999	3137	3278	3419	3642	3780	3946
EUT18108B	3161	3309	3458	3620	3842	3987	4166
EUT21108B	3328	3484	3638	3795	4045	4202	4387
EUT24108B-1	3494	3659	3823	3988	4251	4412	4610
EUT24108B-2	3781	3959	4137	4315	4604	4782	4996
EUT27108B	3974	4161	4352	4539	4839	5026	5251
EUT30108B	4169	4369	4565	4762	5081	5277	5513
EUT33108B	4348	4552	4761	4966	5299	5503	5754
EUT36108B	4522	4739	4957	5170	5516	5734	5990
EUT39108B	4712	4933	5160	5382	5742	5964	6235
EUT42108B	4900	5135	5371	5603	5977	6214	6491

120" HIGH	A	B	C	D	E	F	G
<b>24" DEEP</b>	3 Adjustable Shelves, 4 Adjustable Roll Trays						
EUT15120B	3113	3256	3403	3549	3781	3924	4096
EUT18120B	3281	3435	3590	3758	3989	4140	4325
EUT21120B	3455	3618	3777	3939	4200	4363	4554
EUT24120B-1	3628	3798	3969	4140	4414	4581	4786
EUT24120B-2	3925	4110	4295	4480	4780	4965	5187
EUT27120B	4126	4319	4518	4713	5024	5218	5451
EUT30120B	4328	4535	4740	4944	5275	5479	5724
EUT33120B	4514	4726	4943	5156	5501	5714	5974
EUT36120B	4694	4920	5146	5367	5726	5953	6218
EUT39120B	4891	5121	5357	5587	5961	6192	6473
EUT42120B	5087	5331	5577	5817	6206	6451	6739

**DESIGN NOTES:** Height modifications affect the upper section only unless otherwise specified.

# ELAN TALL CABINETS

## UTILITY CABINET - STYLE C

84", 90", 93", 96", 102", 108" & 120" HIGH

- Subtoe is Shipped Attached Unless Specified "Ship Subtoe Loose"
- Adjustable Shelves on Top and Bottom Right Sections.
- Bottom Left Section is Open.
- Cabinets over 96" high with Finished Side or Finished Interior, not available in Foil.

### BUTT DOORS

24-2"W - 36"W

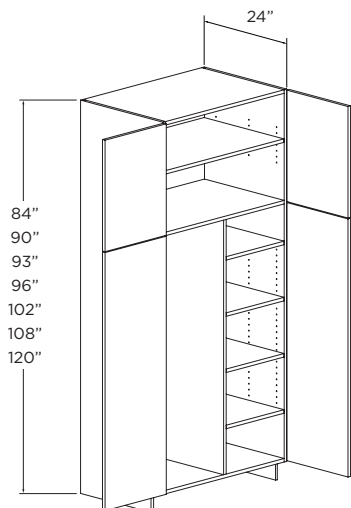

CABINET HEIGHT	TOP SECTION HEIGHT
84"	24"
90"	30"
93"	33"
96"	36"
102"	42"
108"	48"
120"	60"

84" HIGH	A	B	C	D	E	F	G
<b>24" DEEP</b>	5 Adjustable Shelves (1 Upper, 4 Lower)						
EUT2484C-2	3007	3158	3308	3458	3699	3850	4031
EUT2784C	3266	3430	3594	3755	4019	4181	4380
EUT3084C	3526	3702	3879	4055	4337	4513	4725
EUT3384C	3684	3869	4054	4240	4534	4716	4940
EUT3684C	3840	4032	4225	4417	4724	4916	5146

90" HIGH	A	B	C	D	E	F	G
<b>24" DEEP</b>	5 Adjustable Shelves (1 Upper, 4 Lower)						
EUT2490C-2	3187	3346	3506	3666	3921	4079	4271
EUT2790C	3458	3630	3805	3979	4255	4425	4636
EUT3090C	3729	3914	4101	4289	4587	4773	4996
EUT3390C	3903	4094	4291	4487	4798	4995	5228
EUT3690C	4066	4269	4473	4676	5001	5205	5449

93" HIGH	A	B	C	D	E	F	G
<b>24" DEEP</b>	5 Adjustable Shelves (1 Upper, 4 Lower)						
EUT2493C-2	3273	3436	3600	3764	4026	4190	4386
EUT2793C	3554	3728	3907	4086	4369	4548	4761
EUT3093C	3826	4018	4209	4401	4707	4899	5128
EUT3393C	4003	4203	4405	4606	4926	5127	5367
EUT3693C	4176	4385	4594	4803	5137	5346	5597

96" HIGH	A	B	C	D	E	F	G
<b>24" DEEP</b>	6 Adjustable Shelves (2 Upper, 4 Lower)						
EUT2496C-2	3358	3526	3694	3863	4131	4300	4500
EUT2796C	3644	3826	4009	4193	4484	4667	4885
EUT3096C	3925	4122	4319	4515	4829	5026	5260
EUT3396C	4106	4312	4519	4726	5053	5260	5502
EUT3696C	4287	4501	4716	4932	5274	5488	5746

102" HIGH	A	B	C	D	E	F	G
<b>24" DEEP</b>	6 Adjustable Shelves (2 Upper, 4 Lower)						
EUT24102C-2	3560	3738	3906	4074	4339	4504	4702
EUT27102C	3862	4055	4250	4445	4753	4947	5179
EUT30102C	4163	4372	4581	4791	5123	5333	5578
EUT33102C	4355	4573	4792	5012	5359	5579	5835
EUT36102C	4547	4774	5003	5232	5595	5824	6096

108" HIGH	A	B	C	D	E	F	G
<b>24" DEEP</b>	6 Adjustable Shelves (2 Upper, 4 Lower)						
EUT24108C-2	3773	3962	4140	4318	4600	4774	4984
EUT27108C	4094	4299	4505	4711	5038	5244	5489
EUT30108C	4413	4634	4856	5079	5431	5653	5913
EUT33108C	4616	4847	5080	5312	5681	5913	6185
EUT36108C	4819	5060	5303	5546	5931	6174	6462

120" HIGH	A	B	C	D	E	F	G
<b>24" DEEP</b>	7 Adjustable Shelves (3 Upper, 4 Lower)						
EUT24120C-2	4232	4443	4643	4843	5159	5354	5590
EUT27120C	4591	4821	5052	5284	5650	5882	6156
EUT30120C	4950	5197	5446	5696	6091	6340	6631
EUT33120C	5177	5436	5697	5958	6371	6632	6936
EUT36120C	5405	5675	5948	6220	6651	6924	7247

**DESIGN NOTES:** Height modifications affect the upper section only unless otherwise specified.



# ELAN TALL CABINETS

## UTILITY CABINET - STYLE D 84", 90", 93", 96", 102", 108" & 120" HIGH

- Subtoe is Shipped Attached Unless Specified "Ship Subtoe Loose"
- Adjustable Shelves on Top
- Roll Trays on Bottom Right
- Bottom Left Section is Open.
- Cabinets over 96" high with Finished Side or Finished Interior, not available in Foil.
- Roll trays are 3" high, dovetailed with undermount, full extension, soft close glides.

### BUTT DOORS

24-2"W - 36"W

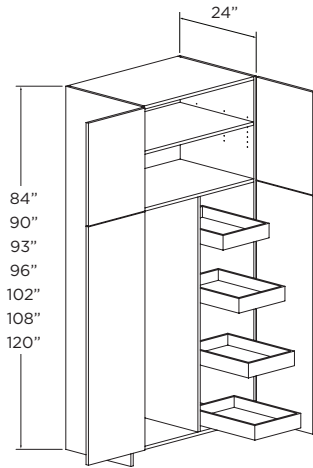

CABINET HEIGHT	TOP SECTION HEIGHT
84"	24"
90"	30"
93"	33"
96"	36"
102"	42"
108"	48"
120"	60"

84" HIGH	A	B	C	D	E	F	G
<b>24" DEEP</b>	1 Adjustable Shelf, 4 Adjustable Roll Trays						
EUT2484D-2	3797	3977	4158	4337	4626	4806	5022
EUT2784D	4061	4251	4447	4638	4949	5140	5370
EUT3084D	4314	4520	4726	4933	5262	5468	5715
EUT3384D	4477	4687	4903	5118	5461	5672	5929
EUT3684D	4628	4850	5072	5293	5648	5870	6136

90" HIGH	A	B	C	D	E	F	G
<b>24" DEEP</b>	1 Adjustable Shelf, 4 Adjustable Roll Trays						
EUT2490D-2	3974	4164	4353	4542	4844	5033	5259
EUT2790D	4251	4451	4656	4856	5181	5382	5622
EUT3090D	4515	4731	4947	5163	5509	5725	5984
EUT3390D	4690	4911	5137	5363	5721	5942	6212
EUT3690D	4853	5086	5319	5553	5925	6158	6438

93" HIGH	A	B	C	D	E	F	G
<b>24" DEEP</b>	1 Adjustable Shelf, 4 Adjustable Roll Trays						
EUT2493D-2	4061	4254	4449	4642	4951	5144	5377
EUT2793D	4343	4548	4757	4966	5293	5503	5748
EUT3093D	4615	4836	5057	5279	5632	5853	6119
EUT3393D	4790	5020	5251	5482	5848	6124	6355
EUT3693D	4963	5202	5440	5679	6060	6298	6584

96" HIGH	A	B	C	D	E	F	G
<b>24" DEEP</b>	2 Adjustable Shelves, 4 Adjustable Roll Trays						
EUT2496D-2	4147	4345	4543	4740	5056	5253	5490
EUT2796D	4436	4645	4858	5067	5407	5616	5871
EUT3096D	4714	4940	5166	5392	5754	5979	6251
EUT3396D	4898	5133	5369	5605	5980	6216	6498
EUT3696D	5075	5319	5564	5807	6197	6441	6734

102" HIGH	A	B	C	D	E	F	G
<b>24" DEEP</b>	2 Adjustable Shelves, 4 Adjustable Roll Trays						
EUT24102D-2	4345	4549	4758	4963	5295	5500	5750
EUT27102D	4645	4863	5087	5306	5661	5880	6147
EUT30102D	4937	5174	5412	5650	6028	6266	6551
EUT33102D	5130	5376	5623	5871	6263	6511	6806
EUT36102D	5315	5570	5826	6082	6489	6745	7051

108" HIGH	A	B	C	D	E	F	G
<b>24" DEEP</b>	2 Adjustable Shelves, 4 Adjustable Roll Trays						
EUT24108D-2	4549	4763	4982	5196	5544	5759	6020
EUT27108D	4863	5092	5326	5555	5927	6156	6436
EUT30108D	5169	5418	5667	5916	6311	6561	6859
EUT33108D	5371	5629	5888	6147	6558	6817	7126
EUT36108D	5564	5831	6100	6368	6794	7062	7383

120" HIGH	A	B	C	D	E	F	G
<b>24" DEEP</b>	3 Adjustable Shelves, 4 Adjustable Roll Trays						
EUT24120D-2	4986	5221	5461	5696	6077	6312	6599
EUT27120D	5330	5581	5838	6089	6496	6747	7054
EUT30120D	5666	5938	6211	6484	6918	7191	7518
EUT33120D	5887	6170	6454	6737	7188	7472	7811
EUT36120D	6099	6392	6686	6980	7447	7741	8092

**DESIGN NOTES:** Height modifications affect the upper section only unless otherwise specified.

# ELAN TALL CABINETS

## UTILITY CABINET - STYLE E 84", 90", 93" & 96" HIGH

- Subtoe is Shipped Attached Unless Specified "Ship Subtoe Loose"
- Adjustable Shelves on Top Section
- 3 Bottom Drawers

### SINGLE DOOR

- Specify Hinge (L or R)
- 15"W - 24-1"W

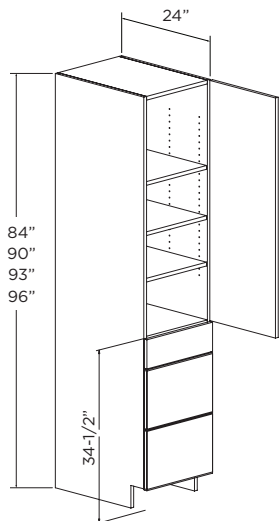

### BUTT DOORS

24-2"W - 36"W

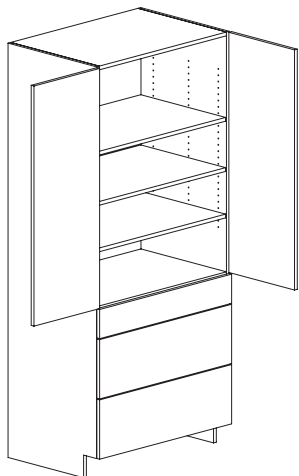

84" HIGH	A	B	C	D	E	F	G
<b>24" DEEP</b>	3 Adjustable Shelves						
EUT1584E	2421	2542	2663	2784	2978	3099	3245
EUT1884E	2576	2704	2834	2963	3169	3297	3452
EUT2184E	2712	2847	2983	3119	3336	3472	3634
EUT2484E-1	2828	2969	3111	3252	3478	3620	3790
EUT2484E-2	2958	3106	3254	3402	3639	3787	3965
EUT2784E	3221	3383	3544	3705	3963	4123	4317
EUT3084E	3405	3575	3746	3916	4188	4358	4562
EUT3384E	3593	3773	3952	4132	4419	4599	4815
EUT3684E	3741	3928	4115	4302	4601	4789	5013

90" HIGH	A	B	C	D	E	F	G
<b>24" DEEP</b>	4 Adjustable Shelves						
EUT1590E	2566	2694	2823	2951	3156	3285	3439
EUT1890E	2721	2857	2994	3130	3347	3484	3647
EUT2190E	2857	3000	3143	3286	3515	3658	3829
EUT2490E-1	2972	3121	3270	3418	3656	3804	3983
EUT2490E-2	3101	3257	3412	3567	3815	3971	4157
EUT2790E	3364	3533	3702	3869	4138	4307	4509
EUT3090E	3548	3725	3903	4081	4364	4542	4754
EUT3390E	3734	3921	4108	4295	4593	4780	5004
EUT3690E	3881	4076	4270	4465	4775	4968	5202

93" HIGH	A	B	C	D	E	F	G
<b>24" DEEP</b>	4 Adjustable Shelves						
EUT1593E	2672	2806	2940	3073	3287	3422	3582
EUT1893E	2824	2965	3106	3248	3474	3615	3785
EUT2193E	2957	3105	3253	3401	3638	3786	3963
EUT2493E-1	3070	3224	3378	3531	3776	3930	4114
EUT2493E-2	3198	3358	3518	3679	3934	4094	4286
EUT2793E	3456	3628	3802	3976	4252	4424	4632
EUT3093E	3634	3817	3999	4180	4471	4653	4870
EUT3393E	3820	4011	4203	4394	4699	4890	5120
EUT3693E	3965	4163	4362	4560	4877	5076	5313

96" HIGH	A	B	C	D	E	F	G
<b>24" DEEP</b>	4 Adjustable Shelves						
EUT1596E	2775	2914	3053	3192	3414	3553	3719
EUT1896E	2925	3072	3219	3364	3599	3746	3921
EUT2196E	3057	3210	3364	3517	3762	3914	4098
EUT2496E-1	3167	3326	3485	3643	3896	4055	4245
EUT2496E-2	3293	3458	3623	3789	4051	4216	4413
EUT2796E	3548	3725	3903	4081	4364	4542	4754
EUT3096E	3725	3911	4098	4285	4582	4769	4991
EUT3396E	3905	4100	4296	4491	4803	4999	5232
EUT3696E	4046	4249	4451	4654	4978	5180	5423

**DESIGN NOTES:** Height modifications affect the upper section only unless otherwise specified.



# ELAN TALL CABINETS

## UTILITY CABINET - STYLE E 102", 108" & 120" HIGH

- Subtoe is Shipped Attached Unless Specified "Ship Subtoe Loose"
- Adjustable Shelves on Top Section
- 3 Bottom Drawers
- Cabinets over 96" high with Finished Side or Finished Interior, not available in Foil.

### SINGLE DOOR

- Specify Hinge (L or R)
- 15"W - 24-1"W

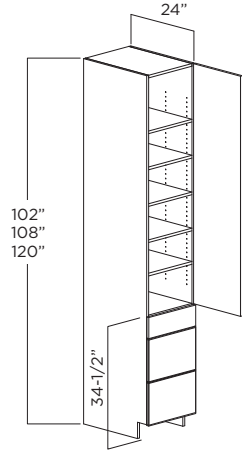

### BUTT DOORS

24-2"W - 36"W

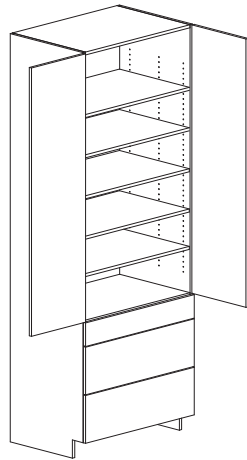

102" HIGH	A	B	C	D	E	F	G
<b>24" DEEP</b>	5 Adjustable Shelves						
EUT15102E	2951	3099	3248	3396	3632	3781	3957
EUT18102E	3114	3269	3426	3583	3828	3985	4172
EUT21102E	3251	3413	3577	3741	4000	4164	4359
EUT24102E-1	3371	3539	3709	3876	4145	4315	4516
EUT24102E-2	3502	3677	3854	4030	4310	4486	4692
EUT27102E	3776	3964	4151	4341	4642	4832	5058
EUT30102E	3964	4163	4358	4558	4874	5074	5307
EUT33102E	4155	4362	4572	4777	5108	5318	5566
EUT36102E	4304	4519	4736	4949	5297	5509	5767

108" HIGH	A	B	C	D	E	F	G
<b>24" DEEP</b>	5 Adjustable Shelves						
EUT15108E	3128	3285	3442	3600	3850	4007	4195
EUT18108E	3300	3465	3632	3798	4058	4224	4422
EUT21108E	3446	3618	3792	3965	4240	4414	4620
EUT24108E-1	3573	3752	3932	4108	4393	4573	4787
EUT24108E-2	3712	3898	4085	4272	4569	4756	4974
EUT27108E	4002	4202	4400	4601	4921	5122	5362
EUT30108E	4202	4412	4620	4831	5167	5379	5626
EUT33108E	4404	4624	4846	5063	5415	5637	5900
EUT36108E	4562	4791	5020	5246	5614	5840	6113

120" HIGH	A	B	C	D	E	F	G
<b>24" DEEP</b>	6 Adjustable Shelves						
EUT15120E	3326	3492	3659	3827	4092	4260	4459
EUT18120E	3508	3684	3861	4038	4314	4491	4701
EUT21120E	3663	3846	4031	4215	4508	4692	4911
EUT24120E-1	3798	3988	4180	4367	4670	4862	5089
EUT24120E-2	3947	4144	4343	4542	4857	5055	5288
EUT27120E	4254	4467	4677	4891	5231	5445	5700
EUT30120E	4467	4690	4911	5136	5492	5718	5980
EUT33120E	4681	4916	5152	5383	5756	5992	6272
EUT36120E	4850	5093	5337	5576	5968	6208	6498

**DESIGN NOTES:** Height modifications affect the upper section only unless otherwise specified.

# ELAN TALL CABINETS

## UTILITY CABINET - STYLE F 84", 90", 93" & 96" HIGH

- Subtoe is Shipped Attached Unless Specified "Ship Subtoe Loose"
- Adjustable Shelves on Top and Bottom

### SINGLE DOOR

- Specify Hinge (L or R)
- 15"W - 24-1"W

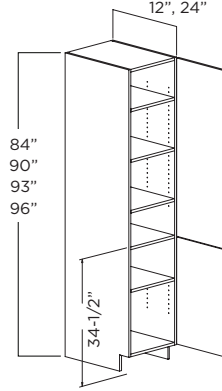

### BUTT DOORS

24-2"W - 36"W

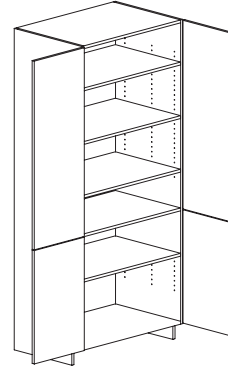

### DOUBLE DOORS

39"W - 42"W

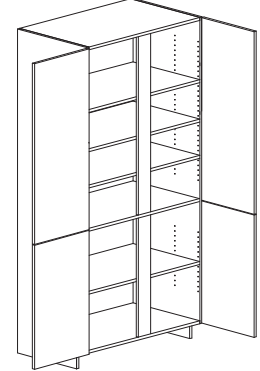

**DESIGN NOTES:** Height modifications affect the upper section only unless otherwise specified.

84" HIGH	A	B	C	D	E	F	G
<b>12" DEEP</b>	4 Adjustable Shelves (3 Upper, 1 Lower)						
EUT158412F	1392	1462	1532	1601	1713	1782	1867
EUT188412F	1501	1576	1652	1727	1847	1922	2012
EUT218412F	1612	1693	1774	1855	1984	2065	2161
EUT248412F-1	1724	1811	1896	1983	2121	2207	2311
EUT248412F-2	1957	2055	2154	2252	2408	2506	2623
EUT278412F	2093	2198	2303	2407	2575	2680	2806
EUT308412F	2234	2345	2457	2570	2748	2859	2994
EUT338412F	2378	2496	2616	2735	2925	3044	3187
EUT368412F	2489	2614	2738	2863	3062	3187	3336
EUT398412F	2649	2782	2915	3049	3260	3391	3550
EUT428412F	2832	2977	3116	3259	3486	3628	3798
<b>24" DEEP</b>	4 Adjustable Shelves (3 Upper, 1 Lower)						
EUT1584F	1764	1853	1940	2029	2171	2258	2364
EUT1884F	1892	1988	2081	2176	2329	2422	2535
EUT2184F	2037	2138	2241	2342	2506	2606	2729
EUT2484F-1	2141	2248	2353	2461	2634	2740	2868
EUT2484F-2	2271	2385	2499	2612	2795	2907	3044
EUT2784F	2456	2579	2703	2824	3022	3144	3291
EUT3084F	2642	2775	2907	3038	3249	3381	3540
EUT3384F	2790	2930	3068	3209	3434	3571	3738
EUT3684F	2940	3087	3235	3380	3617	3763	3940
EUT3984F	3219	3380	3542	3704	3961	4120	4313
EUT4284F	3441	3616	3786	3960	4235	4409	4615

90" HIGH	A	B	C	D	E	F	G
<b>12" DEEP</b>	5 Adjustable Shelves (4 Upper, 1 Lower)						
EUT159012F	1524	1600	1677	1754	1875	1952	2043
EUT189012F	1631	1713	1795	1877	2006	2088	2186
EUT219012F	1745	1831	1919	2007	2147	2234	2339
EUT249012F-1	1856	1949	2042	2134	2284	2377	2488
EUT249012F-2	2089	2193	2298	2403	2571	2675	2801
EUT279012F	2226	2337	2450	2561	2738	2850	2984
EUT309012F	2364	2483	2601	2720	2908	3027	3169
EUT339012F	2511	2637	2763	2889	3089	3215	3366
EUT369012F	2669	2802	2937	3069	3282	3416	3576
EUT399012F	2840	2979	3122	3265	3494	3634	3807
EUT429012F	3024	3175	3328	3480	3722	3874	4055
<b>24" DEEP</b>	5 Adjustable Shelves (4 Upper, 1 Lower)						
EUT1590F	1884	1978	2073	2166	2318	2411	2524
EUT1890F	2068	2171	2276	2379	2545	2648	2771
EUT2190F	2181	2290	2399	2507	2685	2792	2923
EUT2490F-1	2295	2410	2523	2639	2824	2938	3075
EUT2490F-2	2438	2560	2681	2804	3000	3120	3267
EUT2790F	2636	2768	2900	3032	3243	3374	3532
EUT3090F	2833	2974	3116	3258	3485	3626	3796
EUT3390F	2994	3144	3293	3443	3685	3833	4012
EUT3690F	3243	3405	3568	3728	3987	4151	4345
EUT3990F	3450	3619	3793	3967	4245	4416	4626
EUT4290F	3675	3858	4043	4229	4522	4707	4927

93" HIGH	A	B	C	D	E	F	G
<b>12" DEEP</b>	5 Adjustable Shelves (4 Upper, 1 Lower)						
EUT159312F	1603	1683	1764	1844	1972	2053	2148
EUT189312F	1709	1795	1880	1966	2103	2188	2291
EUT219312F	1818	1908	2000	2092	2237	2328	2436
EUT249312F-1	1927	2023	2120	2216	2370	2467	2582
EUT249312F-2	2152	2259	2367	2474	2647	2754	2884
EUT279312F	2285	2399	2513	2628	2811	2925	3062
EUT309312F	2421	2542	2663	2784	2978	3099	3245
EUT339312F	2562	2691	2819	2947	3153	3280	3434
EUT369312F	2671	2804	2939	3072	3286	3419	3579
EUT399312F	2829	2970	3113	3253	3478	3621	3790
EUT429312F	3004	3155	3303	3454	3694	3845	4025
<b>24" DEEP</b>	5 Adjustable Shelves (4 Upper, 1 Lower)						
EUT1593F	1945	2042	2138	2237	2391	2489	2606
EUT1893F	2137	2245	2351	2458	2628	2735	2863
EUT2193F	2254	2366	2480	2592	2773	2885	3021
EUT2493F-1	2373	2490	2609	2727	2917	3037	3180
EUT2493F-2	2521	2645	2771	2897	3099	3226	3378
EUT2793F	2725	2861	2998	3133	3351	3488	3652
EUT3093F	2927	3073	3220	3367	3600	3746	3922
EUT3393F	3095	3249	3405	3559	3807	3962	4148
EUT3693F	3260	3424	3587	3751	4011	4174	4369
EUT3993F	3437	3609	3782	3952	4226	4399	4605
EUT4293F	3650	3833	4013	4197	4488	4672	4891

96" HIGH	A	B	C	D	E	F	G
<b>12" DEEP</b>	5 Adjustable Shelves (4 Upper, 1 Lower)						
EUT159612F	1670	1753	1837	1921	2055	2138	2238
EUT189612F	1771	1859	1949	2038	2180	2268	2374
EUT219612F	1877	1971	2065	2159	2309	2402	2515
EUT249612F-1	1982	2081	2181	2280	2438	2537	2656
EUT249612F-2	2201	2311	2421	2531	2707	2817	2949
EUT279612F	2329	2445	2562	2678	2866	2982	3121
EUT309612F	2460	2583	2707	2829	3026	3149	3297
EUT339612F	2598	2727	2858	2988	3196	3325	3482
EUT369612F	2745	2882	3020	3159	3375	3513	3677
EUT399612F	2901	3046	3192	3339	3570	3713	3887
EUT429612F	3069	3223	3378	3532	3777	3932	4116
<b>24" DEEP</b>	5 Adjustable Shelves (4 Upper, 1 Lower)						
EUT1596F	2005	2104	2205	2306	2467	2566	2687
EUT1896F	2205	2317	2427	2535	2714	2823	2955
EUT2196F	2328	2444	2560	2676	2863	2979	3119
EUT2496F-1	2449	2572	2693	2817	3013	3134	3281
EUT2496F-2	2601	2731	2862	2991	3201	3330	3487
EUT2796F	2813	2954	3095	3236	3462	3600	3769
EUT3096F	3022	3174	3325	3476	3719	3868	4049
EUT3396F	3196	3356	3515	3675	3933	4090	4282
EUT3696F	3359	3527	3697	3866	4131	4300	4501
EUT3996F	3551	3729	3907	4086	4370	4545	4758
EUT4296F	3757	3945	4134	4323	4623	4813	5037

# ELAN TALL CABINETS

## UTILITY CABINET - STYLE F 102", 108" & 120" HIGH

- Subtoe is Shipped Attached Unless Specified "Ship Subtoe Loose"
- Adjustable Shelves on Top and Bottom
- Cabinets over 96" high with Finished Side or Finished Interior, not available in Foil.

### SINGLE DOOR

- Specify Hinge (L or R)
- 15"W - 24-1"W

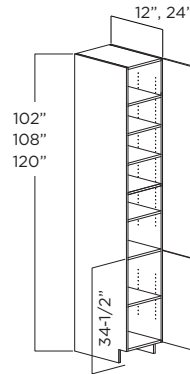

### BUTT DOORS

24-2"W - 36"W

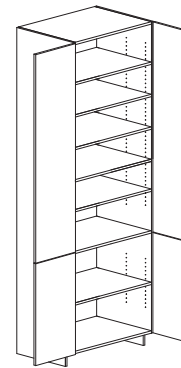

### DOUBLE DOORS

39"W - 42"W

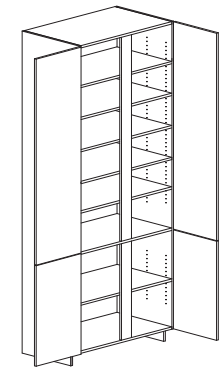

**DESIGN NOTES:** Height modifications affect the upper section only unless otherwise specified.

102" HIGH	A	B	C	D	E	F	G	108" HIGH	A	B	C	D	E	F	G
<b>12" DEEP</b>	6 Adjustable Shelves (5 Upper, 1 Lower)							<b>12" DEEP</b>	6 Adjustable Shelves (5 Upper, 1 Lower)						
EUT1510212F	1838	1928	2020	2113	2259	2352	2462	EUT1510812F	2005	2106	2207	2308	2470	2569	2689
EUT1810212F	1948	2045	2144	2242	2397	2495	2612	EUT1810812F	2128	2234	2341	2449	2618	2726	2853
EUT2110212F	2065	2168	2272	2374	2539	2643	2766	EUT2110812F	2255	2368	2482	2593	2773	2887	3022
EUT2410212F-1	2180	2290	2399	2507	2681	2791	2921	EUT2410812F-1	2382	2501	2621	2738	2928	3049	3191
EUT2410212F-2	2420	2541	2663	2785	2978	3098	3243	EUT2410812F-2	2644	2776	2909	3042	3253	3384	3542
EUT2710212F	2561	2689	2818	2947	3151	3280	3434	EUT2710812F	2797	2937	3078	3219	3442	3583	3750
EUT3010212F	2707	2842	2978	3112	3328	3464	3626	EUT3010812F	2957	3104	3253	3399	3635	3784	3961
EUT3310212F	2858	3001	3145	3286	3514	3658	3829	EUT3310812F	3122	3278	3436	3590	3839	3996	4183
EUT3610212F	3018	3169	3321	3473	3711	3863	4044	EUT3610812F	3247	3406	3570	3733	3995	4155	4350
EUT3910212F	3190	3350	3511	3671	3926	4084	4274	EUT3910812F	3377	3542	3712	3882	4152	4322	4524
EUT4210212F	3375	3544	3714	3884	4154	4324	4526	EUT4210812F	3512	3684	3861	4038	4318	4494	4704
<b>24" DEEP</b>	6 Adjustable Shelves (5 Upper, 1 Lower)							<b>24" DEEP</b>	6 Adjustable Shelves (5 Upper, 1 Lower)						
EUT15102F	2249	2360	2473	2586	2765	2879	3013	EUT15108F	2455	2577	2701	2825	3021	3142	3291
EUT18102F	2384	2504	2624	2744	2934	3054	3197	EUT18108F	2604	2735	2866	2997	3205	3336	3492
EUT21102F	2527	2654	2781	2906	3108	3235	3386	EUT21108F	2761	2899	3038	3174	3397	3534	3699
EUT24102F-1	2669	2802	2937	3069	3282	3416	3576	EUT24108F-1	2915	3061	3208	3352	3588	3731	3906
EUT24102F-2	2962	3111	3260	3409	3646	3792	3969	EUT24108F-2	3236	3398	3561	3724	3982	4142	4339
EUT27102F	3134	3291	3449	3607	3857	4015	4203	EUT27108F	3427	3598	3771	3940	4214	4386	4591
EUT30102F	3313	3479	3646	3809	4073	4240	4439	EUT30108F	3619	3800	3982	4161	4453	4632	4848
EUT33102F	3499	3673	3850	4022	4302	4478	4687	EUT33108F	3821	4013	4201	4394	4699	4891	5120
EUT36102F	3694	3879	4065	4252	4542	4729	4950	EUT36108F	3974	4173	4373	4569	4887	5087	5325
EUT39102F	3905	4100	4297	4494	4805	4998	5232	EUT39108F	4141	4344	4553	4761	5091	5295	5547
EUT42102F	4131	4338	4546	4755	5084	5292	5540	EUT42108F	4307	4522	4735	4952	5296	5513	5770

120" HIGH	A	B	C	D	E	F	G
<b>12" DEEP</b>	7 Adjustable Shelves (6 Upper, 1 Lower)						
EUT1512012F	2400	2520	2641	2762	2956	3074	3218
EUT1812012F	2546	2674	2802	2930	3134	3262	3414
EUT2112012F	2699	2834	2970	3103	3319	3455	3616
EUT2412012F-1	2850	2993	3137	3277	3505	3648	3819
EUT2412012F-2	3164	3322	3482	3641	3894	4050	4239
EUT2712012F	3347	3515	3684	3852	4119	4288	4488
EUT3012012F	3538	3715	3893	4068	4350	4529	4741
EUT3312012F	3736	3923	4111	4296	4594	4782	5006
EUT3612012F	3886	4076	4272	4468	4781	4973	5205
EUT3912012F	4041	4239	4443	4646	4968	5172	5414
EUT4212012F	4203	4409	4620	4832	5167	5379	5630
<b>24" DEEP</b>	7 Adjustable Shelves (6 Upper, 1 Lower)						
EUT15120F	2938	3085	3233	3381	3615	3760	3939
EUT18120F	3117	3273	3430	3587	3836	3993	4179
EUT21120F	3304	3469	3636	3799	4066	4229	4426
EUT24120F-1	3489	3663	3839	4011	4293	4466	4674
EUT24120F-2	3873	4066	4261	4457	4766	4957	5193
EUT27120F	4101	4306	4513	4715	5043	5249	5495
EUT30120F	4331	4547	4766	4979	5329	5543	5802
EUT33120F	4573	4802	5028	5258	5623	5854	6127
EUT36120F	4756	4994	5234	5468	5848	6088	6372
EUT39120F	4956	5199	5448	5698	6093	6337	6639
EUT42120F	5154	5412	5666	5926	6337	6597	6906

# ELAN TALL CABINETS

## TALL PULL-OUT STORAGE 84", 90", 93" & 96" HIGH

- Subtoe is Shipped Attached Unless Specified "Ship Subtoe Loose"
- Decrease Depth Not Available
- 300 lb. Limit
- Pull-Out Attached to Door
- 2 Adjustable Shelves per Pull-Out

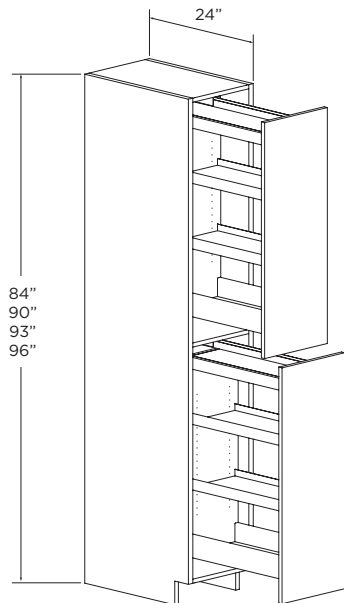

84" HIGH	A	B	C	D	E	F	G
ETPS984A	4397	4617	4837	5057	5410	5630	5892
ETPS1284A	4958	5207	5455	5703	6099	6347	6646
ETPS1584A	5333	5599	5867	6133	6560	6826	7147

90" HIGH	A	B	C	D	E	F	G
ETPS990A	4559	4786	5015	5243	5608	5836	6109
ETPS1290A	5119	5374	5631	5888	6297	6553	6859
ETPS1590A	5490	5765	6040	6314	6753	7028	7357

93" HIGH	A	B	C	D	E	F	G
ETPS993A	4723	4958	5196	5432	5809	6045	6329
ETPS1293A	5281	5545	5809	6073	6496	6760	7077
ETPS1593A	5654	5936	6220	6502	6955	7237	7577

96" HIGH	A	B	C	D	E	F	G
ETPS996A	4883	5127	5372	5616	6006	6251	6543
ETPS1296A	5441	5714	5987	6258	6693	6966	7292
ETPS1596A	5813	6104	6395	6686	7150	7441	7790

**DESIGN NOTES:** Height modifications affect the upper section only unless otherwise specified.

# ELAN TALL CABINETS

## SINGLE OVEN - STYLE A (A) 84", 90", 93", 96", 102", 108" & 120" HIGH

- Subtoe is Shipped Attached Unless Specified "Ship Subtoe Loose"
- 1 Full Depth Shelf - Bottom Section
- Oven Cabinet Shipped with Minimum Cutouts
- Specify Appliance Cutout, if needed, No Charge
- Cabinets over 96" high with Finished Side or Finished Interior, not available in Foil.

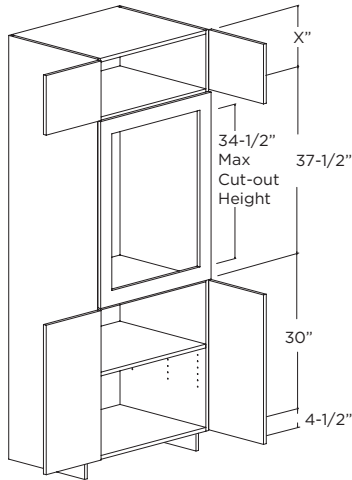

CABINET WIDTH	CUTOUT WIDTH		CUTOUT HEIGHT	
	Min.	Max.	Min.	Max.
27"	21"	25"	27-1/2"	34-1/2"
30"	24"	28"	27-1/2"	34-1/2"
33"	27"	31"	27-1/2"	34-1/2"
36"	30"	34"	27-1/2"	34-1/2"

84" HIGH	A	B	C	D	E	F	G
12" High Top Section							
EOSA2784A	3067	3176	3285	3394	3567	3676	3806
EOSA3084A	3202	3317	3433	3548	3732	3848	3986
EOSA3384A	3334	3456	3578	3700	3895	4017	4163
EOSA3684A	3473	3602	3732	3862	4067	4195	4349

90" HIGH	A	B	C	D	E	F	G
18" High Top Section							
EOSA2790A	3231	3347	3464	3582	3769	3885	4026
EOSA3090A	3364	3488	3611	3735	3933	4056	4204
EOSA3390A	3497	3627	3758	3889	4097	4226	4383
EOSA3690A	3637	3774	3913	4051	4270	4408	4572

93" HIGH	A	B	C	D	E	F	G
21" High Top Section, 2 Adjustable Shelves (1 Upper, 1 Lower)							
EOSA2793A	3315	3436	3557	3678	3873	3994	4138
EOSA3093A	3446	3573	3702	3829	4033	4161	4314
EOSA3393A	3574	3709	3843	3977	4191	4325	4485
EOSA3693A	3712	3852	3994	4136	4361	4500	4668

96" HIGH	A	B	C	D	E	F	G
24" High Top Section, 2 Adjustable Shelves (1 Upper, 1 Lower)							
EOSA2796A	3402	3527	3653	3779	3979	4104	4254
EOSA3096A	3527	3659	3791	3922	4132	4264	4422
EOSA3396A	3652	3790	3928	4066	4286	4424	4589
EOSA3696A	3782	3926	4071	4217	4447	4590	4762

102" HIGH	A	B	C	D	E	F	G
30" High Top Section, 2 Adjustable Shelves (1 Upper, 1 Lower)							
EOSA27102A	3590	3724	3860	3996	4211	4347	4508
EOSA30102A	3724	3866	4008	4151	4377	4516	4688
EOSA33102A	3860	4008	4158	4307	4544	4690	4867
EOSA36102A	3999	4155	4311	4467	4715	4868	5054

108" HIGH	A	B	C	D	E	F	G
36" High Top Section, 2 Adjustable Shelves (1 Upper, 1 Lower)							
EOSA27108A	3792	3936	4082	4228	4459	4605	4779
EOSA30108A	3936	4088	4242	4395	4638	4788	4973
EOSA33108A	4082	4242	4402	4563	4817	4974	5165
EOSA36108A	4232	4399	4537	4735	5001	5166	5366

120" HIGH	A	B	C	D	E	F	G
48" High Top Section, 2 Adjustable Shelves (1 Upper, 1 Lower)							
EOSA27120A	4226	4393	4560	4728	4994	5162	5361
EOSA30120A	4393	4567	4744	4920	5199	5371	5584
EOSA33120A	4560	4744	4928	5113	5405	5586	5805
EOSA36120A	4733	4924	5118	5311	5617	5807	6036

**DESIGN NOTES:** Height modifications affect the upper section only unless otherwise specified.

# ELAN TALL CABINETS

## SINGLE OVEN - STYLE A (B) 84", 90", 93", 96", 102", 108" & 120" HIGH

- Subtoe is Shipped Attached Unless Specified "Ship Subtoe Loose"
- 1 Full Depth Shelf - Bottom Section
- Oven Cabinet Shipped with Minimum Cutouts
- Specify appliance cutout, if needed, no charge
- Cabinets over 96" high with Finished Side or Finished Interior, not available in Foil.

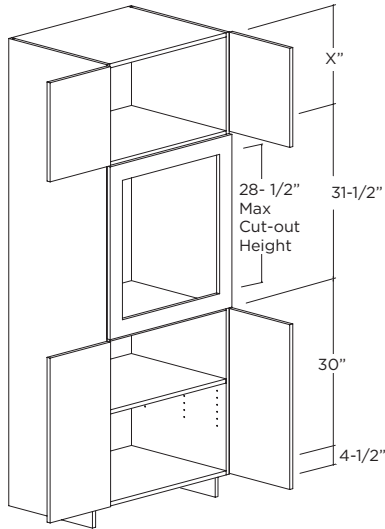

CABINET WIDTH	CUTOUT WIDTH		CUTOUT HEIGHT	
	Min.	Max.	Min.	Max.
27"	21"	25"	21-1/2"	28-1/2"
30"	24"	28"	21-1/2"	28-1/2"
33"	27"	31"	21-1/2"	28-1/2"
36"	30"	34"	21-1/2"	28-1/2"

84" HIGH	A	B	C	D	E	F	G
18" High Top Section, 1 Adjustable Shelf (Lower)							
EOSA2784B	3122	3233	3345	3457	3635	3747	3880
EOSA3084B	3260	3378	3497	3616	3805	3921	4065
EOSA3384B	3397	3522	3645	3771	3971	4097	4247
EOSA3684B	3542	3674	3805	3938	4149	4283	4441

90" HIGH	A	B	C	D	E	F	G
24" High Top Section, 2 Adjustable Shelves (1 Upper, 1 Lower)							
EOSA2790B	3291	3408	3529	3649	3840	3961	4104
EOSA3090B	3420	3554	3679	3806	4011	4136	4288
EOSA3390B	3562	3695	3829	3964	4179	4311	4470
EOSA3690B	3703	3843	3985	4126	4353	4492	4660

93" HIGH	A	B	C	D	E	F	G
27" High Top Section, 2 Adjustable Shelves (1 Upper, 1 Lower)							
EOSA2793B	3377	3501	3624	3749	3949	4072	4220
EOSA3093B	3511	3642	3774	3903	4111	4243	4400
EOSA3393B	3642	3779	3918	4056	4275	4411	4575
EOSA3693B	3779	3923	4069	4214	4444	4586	4759

96" HIGH	A	B	C	D	E	F	G
30" High Top Section, 3 Adjustable Shelves (2 Upper, 1 Lower)							
EOSA2796B	3464	3592	3722	3851	4056	4186	4339
EOSA3096B	3592	3730	3863	3999	4215	4348	4512
EOSA3396B	3722	3863	4006	4145	4371	4513	4682
EOSA3696B	3855	4003	4152	4298	4534	4683	4860

102" HIGH	A	B	C	D	E	F	G
36" High Top Section, 3 Adjustable Shelves (2 Upper, 1 Lower)							
EOSA27102B	3657	3795	3934	4073	4293	4432	4598
EOSA30102B	3795	3942	4086	4232	4463	4607	4783
EOSA33102B	3934	4086	4239	4389	4631	4784	4966
EOSA36102B	4077	4236	4396	4553	4807	4967	5157

108" HIGH	A	B	C	D	E	F	G
42" High Top Section, 3 Adjustable Shelves (2 Upper, 1 Lower)							
EOSA27108B	3864	4012	4162	4311	4548	4698	4875
EOSA30108B	4012	4171	4325	4482	4731	4885	5075
EOSA33108B	4162	4325	4489	4651	4911	5076	5271
EOSA36108B	4315	4486	4658	4827	5100	5272	5477

120" HIGH	A	B	C	D	E	F	G
54" High Top Section, 4 Adjustable Shelves (3 Upper, 1 Lower)							
EOSA27120B	4330	4502	4675	4848	5122	5295	1301
EOSA30120B	4502	4686	4864	5046	5334	5512	5732
EOSA33120B	4675	4864	5054	5241	5542	5733	5959
EOSA36120B	4853	5050	5250	5445	5761	5960	6197

**DESIGN NOTES:** Height modifications affect the upper section only unless otherwise specified.

# ELAN TALL CABINETS

## SINGLE OVEN - STYLE B (A) 84", 90", 93", 96", 102", 108" & 120" HIGH

- Subtoe is Shipped Attached Unless Specified "Ship Subtoe Loose"
- Oven Cabinet Shipped with Minimum Cutouts
- Specify appliance cutout, if needed, no charge
- Cabinets over 96" high with Finished Side or Finished Interior, not available in Foil.

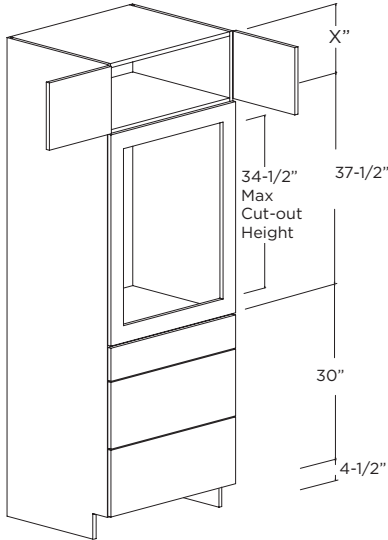

CABINET WIDTH	CUTOUT WIDTH		CUTOUT HEIGHT	
	Min.	Max.	Min.	Max.
27"	21"	25"	27-1/2"	34-1/2"
30"	24"	28"	27-1/2"	34-1/2"
33"	27"	31"	27-1/2"	34-1/2"
36"	30"	34"	27-1/2"	34-1/2"

84" HIGH	A	B	C	D	E	F	G
12" High Top Section							
EOSB2784A	3457	3586	3714	3842	4046	4175	4329
EOSB3084A	3589	3724	3859	3994	4209	4343	4506
EOSB3384A	3711	3852	3994	4134	4359	4500	4670
EOSB3684A	3838	3985	4133	4282	4516	4665	4841

90" HIGH	A	B	C	D	E	F	G
18" High Top Section							
EOSB2790A	3628	3765	3902	4039	4258	4394	4557
EOSB3090A	3763	3906	4050	4193	4423	4566	4738
EOSB3390A	3887	4037	4187	4337	4576	4726	4905
EOSB3690A	4019	4175	4333	4490	4739	4897	5084

93" HIGH	A	B	C	D	E	F	G
21" High Top Section, 1 Adjustable Shelf							
EOSB2793A	3720	3861	4002	4144	4370	4511	4681
EOSB3093A	3850	3997	4145	4293	4529	4677	4854
EOSB3393A	3972	4126	4280	4434	4680	4834	5018
EOSB3693A	4101	4262	4423	4585	4841	5002	5194

96" HIGH	A	B	C	D	E	F	G
24" High Top Section, 1 Adjustable Shelf							
EOSB2796A	3810	3956	4103	4248	4482	4627	4802
EOSB3096A	3939	4090	4243	4396	4639	4791	4974
EOSB3396A	4060	4218	4376	4535	4788	4946	5136
EOSB3696A	4186	4351	4517	4683	4945	5107	5308

102" HIGH	A	B	C	D	E	F	G
30" High Top Section, 1 Adjustable Shelf							
EOSB27102A	4006	4161	4318	4474	4723	4879	5065
EOSB30102A	4142	4305	4468	4632	4891	5055	5249
EOSB33102A	4272	4441	4611	4781	5051	5217	5423
EOSB36102A	4407	4583	4760	4937	5217	5390	5604

108" HIGH	A	B	C	D	E	F	G
36" High Top Section, 2 Adjustable Shelves							
EOSB27108A	4223	4390	4557	4725	4991	5158	5358
EOSB30108A	4370	4544	4719	4894	5171	5346	5554
EOSB33108A	4509	4689	4871	5054	5342	5520	5740
EOSB36108A	4653	4841	5031	5220	5520	5705	5934

120" HIGH	A	B	C	D	E	F	G
48" High Top Section, 3 Adjustable Shelves							
EOSB27120A	4679	4868	5059	5249	5551	5742	5968
EOSB30120A	4845	5043	5242	5441	5756	5955	6191
EOSB33120A	5003	5209	5416	5623	5950	6153	6403
EOSB36120A	5168	5381	5596	5812	6153	6363	6623

**DESIGN NOTES:** Height modifications affect the upper section only unless otherwise specified.

# ELAN TALL CABINETS

## SINGLE OVEN - STYLE B (B)

84", 90", 93", 96", 102", 108" & 120" HIGH

- Subtoe is Shipped Attached Unless Specified "Ship Subtoe Loose"
- Oven Cabinet Shipped with Minimum Cutouts
- Specify Appliance Cutout, if Needed, No Charge
- Cabinets over 96" high with Finished Side or Finished Interior, not available in Foil.

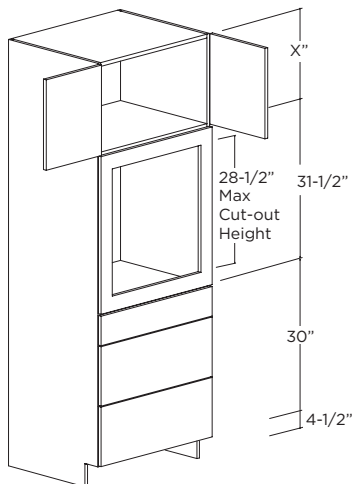

CABINET WIDTH	CUTOUT WIDTH		CUTOUT HEIGHT	
	Min.	Max.	Min.	Max.
27"	21"	25"	21-1/2"	28-1/2"
30"	24"	28"	21-1/2"	28-1/2"
33"	27"	31"	21-1/2"	28-1/2"
36"	30"	34"	21-1/2"	28-1/2"

84" HIGH	A	B	C	D	E	F	G
18" High Top Section							
EOSB2784B	3523	3654	3786	3918	4128	4259	4417
EOSB3084B	3693	3832	3973	4114	4337	4477	4644
EOSB3384B	3850	3997	4145	4293	4529	4677	4854
EOSB3684B	4015	4171	4328	4485	4734	4891	5078

90" HIGH	A	B	C	D	E	F	G
24" High Top Section, 1 Adjustable Shelf							
EOSB2790B	3681	3820	3960	4099	4321	4461	4628
EOSB3090B	3861	4008	4158	4306	4543	4691	4869
EOSB3390B	4030	4187	4345	4501	4752	4908	5097
EOSB3690B	4212	4378	4545	4712	4977	5144	5342

93" HIGH	A	B	C	D	E	F	G
27" High Top Section, 1 Adjustable Shelf							
EOSB2793B	3725	3867	4008	4150	4376	4517	4687
EOSB3093B	3908	4059	4210	4361	4601	4752	4933
EOSB3393B	4081	4240	4400	4559	4814	4973	5164
EOSB3693B	4262	4431	4600	4770	5039	5208	5410

96" HIGH	A	B	C	D	E	F	G
30" High Top Section, 2 Adjustable Shelves							
EOSB2796B	3770	3914	4059	4202	4431	4576	4748
EOSB3096B	3956	4109	4263	4416	4660	4813	4997
EOSB3396B	4131	4292	4455	4616	4875	5037	5231
EOSB3696B	4318	4486	4658	4830	5103	5275	5480

102" HIGH	A	B	C	D	E	F	G
36" High Top Section, 2 Adjustable Shelves							
EOSB27102B	3943	4095	4249	4402	4645	4799	4981
EOSB30102B	4141	4303	4467	4627	4886	5049	5243
EOSB33102B	4326	4497	4670	4839	5117	5286	5491
EOSB36102B	4525	4702	4885	5068	5357	5540	5757

108" HIGH	A	B	C	D	E	F	G
42" High Top Section, 2 Adjustable Shelves							
EOSB27108B	4126	4287	4450	4613	4870	5033	5226
EOSB30108B	4335	4507	4681	4851	5125	5298	5504
EOSB33108B	4532	4713	4897	5076	5370	5549	5767
EOSB36108B	4742	4931	5125	5318	5625	5819	6049

120" HIGH	A	B	C	D	E	F	G
54" High Top Section, 3 Adjustable Shelves							
EOSB27120B	4523	4704	4887	5070	5359	5542	5759
EOSB30120B	4758	4951	5146	5337	5645	5840	6071
EOSB33120B	4979	5183	5388	5590	5920	6121	6366
EOSB36120B	5215	5427	5644	5862	6206	6424	6682

**DESIGN NOTES:** Height modifications affect the upper section only unless otherwise specified.



# ELAN TALL CABINETS

## DOUBLE OVEN - STYLE A 84", 90", 93", 96", 102", 108" & 120" HIGH

- Subtoe is Shipped Attached Unless Specified "Ship Subtoe Loose"
- Oven Cabinet Shipped with Minimum Cutouts
- Specify Appliance Cutout, if Needed, No Charge
- Cabinets over 96" high with Finished Side or Finished Interior, not available in Foil.

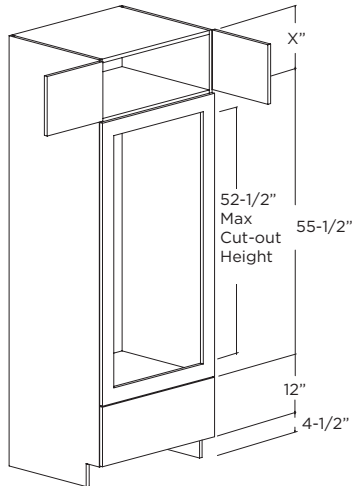

CABINET WIDTH	CUTOUT WIDTH		CUTOUT HEIGHT	
	Min.	Max.	Min.	Max.
27"	21"	24"	45-1/2"	52-1/2"
30"	24"	27"	45-1/2"	52-1/2"
33"	27"	30"	45-1/2"	52-1/2"
36"	30"	33"	45-1/2"	52-1/2"

84" HIGH	A	B	C	D	E	F	G
12" High Top Section							
EOD2784A	3165	3279	3392	3506	3687	3801	3938
EOD3084A	3263	3381	3500	3619	3808	3927	4068
EOD3384A	3363	3486	3610	3733	3931	4055	4203
EOD3684A	3466	3595	3724	3854	4059	4189	4342

90" HIGH	A	B	C	D	E	F	G
18" High Top Section							
EOD2790A	3380	3505	3630	3753	3952	4076	4225
EOD3090A	3483	3612	3742	3872	4078	4208	4363
EOD3390A	3586	3720	3854	3989	4204	4339	4500
EOD3690A	3693	3833	3974	4115	4338	4479	4646

93" HIGH	A	B	C	D	E	F	G
21" High Top Section, 1 Adjustable Shelf							
EOD2793A	3467	3595	3725	3853	4059	4187	4342
EOD3093A	3565	3698	3832	3966	4180	4313	4473
EOD3393A	3665	3803	3942	4081	4302	4441	4608
EOD3693A	3770	3913	4058	4203	4432	4577	4749

96" HIGH	A	B	C	D	E	F	G
24" High Top Section, 1 Adjustable Shelf							
EOD2796A	3551	3685	3818	3950	4163	4296	4455
EOD3096A	3647	3785	3922	4060	4280	4417	4582
EOD3396A	3744	3887	4029	4172	4400	4543	4714
EOD3696A	3844	3992	4140	4289	4524	4673	4849

102" HIGH	A	B	C	D	E	F	G
30" High Top Section, 1 Adjustable Shelf							
EOD27102A	3805	3950	4097	4240	4475	4619	4793
EOD30102A	3909	4060	4212	4360	4604	4753	4933
EOD33102A	4015	4171	4328	4485	4734	4891	5078
EOD36102A	4124	4285	4448	4611	4868	5031	5224

108" HIGH	A	B	C	D	E	F	G
36" High Top Section, 2 Adjustable Shelves							
EOD27108A	4081	4240	4401	4558	4815	4972	5163
EOD30108A	4195	4360	4527	4690	4956	5119	5317
EOD33108A	4311	4482	4654	4826	5098	5271	5475
EOD36108A	4430	4607	4785	4964	5246	5424	5635

120" HIGH	A	B	C	D	E	F	G
48" High Top Section, 2 Adjustable Shelves							
EOD27120A	4686	4875	5066	5254	5560	5747	5974
EOD30120A	4822	5019	5217	5410	5728	5922	6157
EOD33120A	4960	5163	5368	5573	5897	6102	6345
EOD36120A	5102	5312	5524	5736	6072	6284	6536

**DESIGN NOTES:** Height modifications affect the upper section only unless otherwise specified.

# ELAN TALL CABINETS

## DOUBLE OVEN - STYLE B

### 84", 90", 93", 96", 102", 108" & 120" HIGH

- Subtoe is Shipped Attached Unless Specified "Ship Subtoe Loose"
- Oven Cabinet Shipped with Minimum Cutouts
- Specify Appliance Cutout, if Needed, No Charge
- Cabinets over 96" high with Finished Side or Finished Interior, not available in Foil.

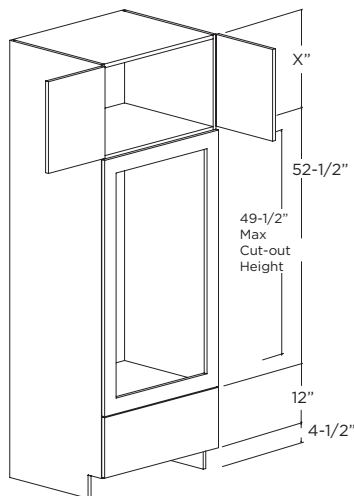

CABINET WIDTH	CUTOUT WIDTH		CUTOUT HEIGHT	
	Min.	Max.	Min.	Max.
27"	21"	25"	42-1/2"	49-1/2"
30"	24"	28"	42-1/2"	49-1/2"
33"	27"	31"	42-1/2"	49-1/2"
36"	30"	34"	42-1/2"	49-1/2"

84" HIGH	A	B	C	D	E	F	G
15" High Top Section							
EOD2784B	3175	3288	3403	3517	3699	3813	3950
EOD3084B	3337	3460	3582	3704	3900	4022	4167
EOD3384B	3417	3543	3670	3796	3997	4123	4275
EOD3684B	3498	3628	3759	3890	4098	4229	4384

90" HIGH	A	B	C	D	E	F	G
21" High Top Section, 1 Adjustable Shelf							
EOD2790B	3313	3434	3555	3676	3869	3990	4136
EOD3090B	3494	3623	3754	3884	4092	4221	4378
EOD3390B	3744	3886	4029	4172	4400	4543	4714
EOD3690B	4017	4173	4330	4488	4737	4894	5081

93" HIGH	A	B	C	D	E	F	G
24" High Top Section, 1 Adjustable Shelf							
EOD2793B	3407	3533	3659	3785	3985	4111	4262
EOD3093B	3617	3753	3890	4026	4243	4380	4543
EOD3393B	3836	3983	4131	4277	4513	4660	4836
EOD3693B	4074	4233	4393	4553	4807	4967	5157

96" HIGH	A	B	C	D	E	F	G
27" High Top Section, 2 Adjustable Shelves							
EOD2796B	3506	3637	3768	3898	4108	4237	4394
EOD3096B	3740	3881	4024	4166	4394	4537	4707
EOD3396B	3925	4077	4229	4380	4622	4774	4956
EOD3696B	4125	4287	4450	4612	4870	5030	5226

102" HIGH	A	B	C	D	E	F	G
33" High Top Section, 2 Adjustable Shelves							
EOD27102B	3666	3804	3944	4083	4304	4441	4607
EOD30102B	3912	4063	4215	4367	4608	4757	4940
EOD33102B	4111	4272	4434	4596	4853	5011	5207
EOD36102B	4323	4495	4668	4840	5114	5283	5492

108" HIGH	A	B	C	D	E	F	G
39" High Top Section, 2 Adjustable Shelves							
EOD27108B	3835	3982	4130	4278	4512	4657	4833
EOD30108B	4096	4256	4418	4579	4834	4992	5187
EOD33108B	4307	4478	4650	4822	5094	5262	5470
EOD36108B	4533	4714	4898	5081	5371	5551	5772

120" HIGH	A	B	C	D	E	F	G
51" High Top Section, 3 Adjustable Shelves							
EOD27120B	4203	4368	4535	4701	4965	5128	5326
EOD30120B	4497	4677	4859	5040	5327	5505	5724
EOD33120B	4735	4927	5120	5314	5620	5809	6043
EOD36120B	4988	5193	5399	5605	5932	6134	6383

**DESIGN NOTES:** Height modifications affect the upper section only unless otherwise specified.

# ELAN TALL CABINETS

## DOUBLE OVEN - STYLE C

84", 90", 93", 96", 102", 108" & 120" HIGH

- Subtoe is Shipped Attached Unless Specified "Ship Subtoe Loose"
- Oven Cabinet Shipped with Minimum Cutouts
- Specify Appliance Cutout, if Needed, No Charge
- Cabinets over 96" high with Finished Side or Finished Interior, not available in Foil.

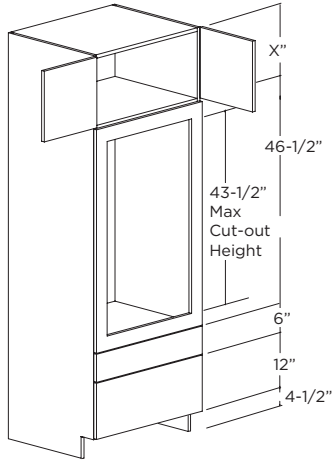

CABINET WIDTH	CUTOUT WIDTH		CUTOUT HEIGHT	
	Min.	Max.	Min.	Max.
27"	21"	24"	36-1/2"	43-1/2"
30"	24"	27"	36-1/2"	43-1/2"
33"	27"	30"	36-1/2"	43-1/2"
36"	30"	33"	36-1/2"	43-1/2"

84" HIGH	A	B	C	D	E	F	G
15" High Top Section							
EOD2784C	3534	3666	3798	3930	4142	4274	4431
EOD3084C	3697	3837	3978	4117	4341	4482	4649
EOD3384C	3850	3997	4145	4293	4529	4677	4854
EOD3684C	4009	4164	4321	4478	4727	4884	5070

90" HIGH	A	B	C	D	E	F	G
21" High Top Section, 1 Adjustable Shelf							
EOD2790C	3671	3809	3949	4088	4310	4449	4615
EOD3090C	3852	4000	4148	4296	4533	4681	4858
EOD3390C	4015	4171	4328	4483	4732	4889	5076
EOD3690C	4187	4351	4517	4683	4945	5111	5308

93" HIGH	A	B	C	D	E	F	G
24" High Top Section, 1 Adjustable Shelf							
EOD2793C	3713	3853	3995	4136	4361	4502	4671
EOD3093C	3975	4130	4284	4438	4685	4839	5023
EOD3393C	4061	4219	4378	4537	4790	4947	5138
EOD3693C	4149	4312	4476	4640	4900	5064	5258

96" HIGH	A	B	C	D	E	F	G
27" High Top Section, 2 Adjustable Shelves							
EOD2796C	3755	3898	4041	4185	4413	4556	4729
EOD3096C	4098	4258	4418	4578	4835	4995	5187
EOD3396C	4188	4352	4518	4684	4947	5112	5309
EOD3696C	4280	4449	4619	4790	5060	5231	5433

102" HIGH	A	B	C	D	E	F	G
33" High Top Section, 2 Adjustable Shelves							
EOD27102C	3904	4054	4206	4357	4597	4746	4926
EOD30102C	4265	4433	4603	4773	5041	5208	5413
EOD33102C	4359	4532	4707	4881	5158	5332	5539
EOD36102C	4456	4634	4813	4993	5277	5456	5669

108" HIGH	A	B	C	D	E	F	G
39" High Top Section, 2 Adjustable Shelves							
EOD27108C	4060	4218	4378	4537	4790	4946	5135
EOD30108C	4440	4617	4796	4974	5257	5432	5648
EOD33108C	4539	4721	4905	5088	5379	5563	5781
EOD36108C	4641	4828	5017	5206	5505	5693	5918

120" HIGH	A	B	C	D	E	F	G
51" High Top Section, 3 Adjustable Shelves							
EOD27120C	4399	4574	4750	4927	5206	5379	5589
EOD30120C	4819	5015	5213	5411	5724	5917	6156
EOD33120C	4929	5131	5334	5537	5859	6062	6303
EOD36120C	5042	5249	5458	5667	5998	6207	6455

**DESIGN NOTES:** Height modifications affect the upper section only unless otherwise specified.

# ELAN TALL CABINETS

## OVEN-MICROWAVE

### 84", 90", 93", 96", 102", 108" & 120" HIGH

- Subtoe is Shipped Attached Unless Specified "Ship Subtoe Loose"
- Oven Cabinet Shipped with Minimum Cutouts
- Specify Appliance Cutout, if Needed, No Charge
- Cabinets over 96" high with Finished Side or Finished Interior, not available in Foil.

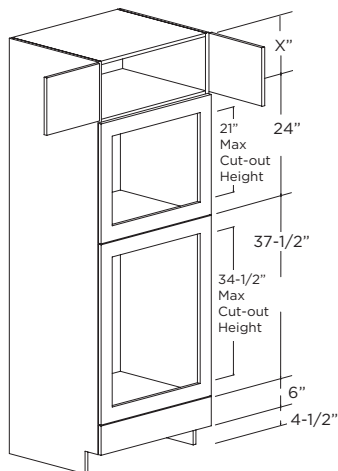

CABINET WIDTH	CUTOUT WIDTH		OVEN CUTOUT HEIGHT		MICROWAVE CUTOUT HEIGHT	
	Min.	Max.	Min.	Max.	Min.	Max.
27"	21"	24"	26-1/2"	34-1/2"	12"	21"
30"	24"	27"	26-1/2"	34-1/2"	12"	21"
33"	27"	30"	26-1/2"	34-1/2"	12"	21"
36"	30"	33"	26-1/2"	34-1/2"	12"	21"

84" HIGH	A	B	C	D	E	F	G
12" High Top Section							
EOM2784	3204	3319	3435	3551	3736	3851	3989
EOM3084	3309	3430	3551	3672	3865	3985	4131
EOM3384	3409	3535	3661	3787	3988	4114	4265
EOM3684	3512	3643	3775	3907	4116	4248	4404

90" HIGH	A	B	C	D	E	F	G
18" High Top Section							
EOM2790	3372	3495	3620	3743	3941	4065	4214
EOM3090	3478	3308	3737	3865	4072	4202	4357
EOM3390	3578	3713	3847	3982	4196	4330	4490
EOM3690	3683	3823	3963	4104	4326	4464	4631

93" HIGH	A	B	C	D	E	F	G
21" High Top Section, 1 Adjustable Shelf							
EOM2793	3456	3584	3713	3841	4045	4174	4326
EOM3093	3560	3693	3826	3960	4174	4307	4466
EOM3393	3659	3797	3935	4073	4295	4433	4599
EOM3693	3761	3904	4049	4190	4422	4566	4738

96" HIGH	A	B	C	D	E	F	G
24" High Top Section, 1 Adjustable Shelf							
EOM2796	3543	3675	3808	3940	4152	4285	4444
EOM3096	3645	3782	3920	4059	4279	4416	4581
EOM3396	3741	3883	4026	4169	4396	4538	4709
EOM3696	3840	3988	4136	4284	4519	4668	4844

102" HIGH	A	B	C	D	E	F	G
30" High Top Section, 1 Adjustable Shelves							
EOM27102	3736	3878	4021	4164	4391	4534	4704
EOM30102	3847	3994	4143	4292	4527	4676	4852
EOM33102	3950	4103	4257	4410	4654	4808	4991
EOM36102	4057	4215	4374	4533	4786	4945	5134

108" HIGH	A	B	C	D	E	F	G
36" High Top Section, 2 Adjustable Shelves							
EOM27108	3953	4106	4260	4414	4658	4812	4995
EOM30108	4072	4231	4391	4551	4804	4964	5154
EOM33108	4183	4347	4513	4679	4941	5107	5303
EOM36108	4298	4468	4640	4811	5083	5254	5458

120" HIGH	A	B	C	D	E	F	G
48" High Top Section, 2 Adjustable Shelves							
EOM27120	4399	4574	4751	4927	5207	5383	5593
EOM30120	4536	4718	4901	5084	5375	5563	5776
EOM33120	4663	4851	5041	5231	5532	5722	5947
EOM36120	4795	4990	5186	5383	5694	5890	6124

**DESIGN NOTES:** Height modifications affect the upper section only unless otherwise specified.

# ELAN TALL CABINETS

## MICROWAVE TALL CABINETS - STYLE A 84", 90", 93", 96", 102", 108" & 120" HIGH

- Subtoe is Shipped Attached Unless Specified "Ship Subtoe Loose"
- Pull-Out Chopping Block/1 Drawer
- 2 Large Drawers in Bottom Section
- Specify appliance cutout, if needed, no charge.
- Cabinets over 96" high with Finished Side or Finished Interior, not available in Foil.

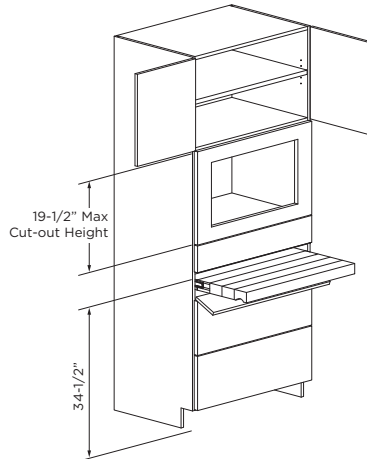

CABINET WIDTH	CUTOUT WIDTH		CUTOUT HEIGHT	
	Min.	Max.	Min.	Max.
27"	21"	24"	12-1/2"	19-1/2"
30"	24"	27"	12-1/2"	19-1/2"
33"	27"	30"	12-1/2"	19-1/2"
36"	30"	33"	12-1/2"	19-1/2"

84" HIGH	A	B	C	D	E	F	G
21" High Top Section, 1 Adjustable Shelf							
ETMA2784	3908	4059	4210	4361	4601	4752	4933
ETMA3084	4103	4263	4424	4584	4841	5001	5193
ETMA3384	4204	4369	4535	4700	4966	5131	5330
ETMA3684	4306	4477	4649	4820	5093	5264	5469

90" HIGH	A	B	C	D	E	F	G
27" High Top Section, 1 Adjustable Shelf							
ETMA2790	4048	4205	4363	4521	4773	4930	5120
ETMA3090	4242	4409	4577	4861	5012	5180	5380
ETMA3390	4343	4516	4688	4861	5137	5309	5516
ETMA3690	4447	4625	4804	4983	5266	5441	5654

93" HIGH	A	B	C	D	E	F	G
30" High Top Section, 1 Adjustable Shelf							
ETMA2793	4187	4352	4517	4681	4945	5109	5307
ETMA3093	4380	4555	4729	4903	5182	5356	5565
ETMA3393	4483	4663	4842	5022	5308	5488	5703
ETMA3693	4591	4776	4962	5148	5443	5626	5847

96" HIGH	A	B	C	D	E	F	G
33" High Top Section, 2 Adjustable Shelves							
ETMA2796	4326	4497	4670	4841	5116	5287	5494
ETMA3096	4521	4702	4884	5065	5354	5537	5754
ETMA3396	4623	4809	4996	5183	5482	5667	5891
ETMA3696	4727	4919	5112	5305	5610	5804	6033

102" HIGH	A	B	C	D	E	F	G
39" High Top Section, 2 Adjustable Shelves							
ETMA27102	4483	4663	4843	5024	5311	5491	5706
ETMA30102	4688	4877	5068	5260	5562	5753	5980
ETMA33102	4794	4989	5185	5382	5693	5889	6123
ETMA36102	4903	5103	5305	5507	5827	6029	6269

108" HIGH	A	B	C	D	E	F	G
45" High Top Section, 2 Adjustable Shelves							
ETMA27108	4483	4663	4843	5024	5311	5491	5706
ETMA30108	4688	4877	5068	5260	5562	5753	5980
ETMA33108	4794	4989	5185	5382	5693	5889	6123
ETMA36108	4903	5103	5305	5507	5827	6029	6269

120" HIGH	A	B	C	D	E	F	G
57" High Top Section, 3 Adjustable Shelves							
ETMA27120	4651	4838	5028	5217	5516	5706	5930
ETMA30120	4865	5063	5263	5463	5780	5980	6217
ETMA33120	4976	5180	5385	5591	5916	6122	6366
ETMA36120	5090	5300	5511	5722	6057	6268	6519

**DESIGN NOTES:** Height modifications affect the upper section only unless otherwise specified.

# ELAN TALL CABINETS

## MICROWAVE TALL CABINETS - STYLE B 84", 90", 93", 96", 102", 108" & 120" HIGH

- Subtoe is Shipped Attached Unless Specified "Ship Subtoe Loose"
- Pull-Out Chopping Block/1 Drawer
- 2 Roll Trays in Bottom Section
- Specify appliance cutout, if needed, no charge.
- Cabinets over 96" high with Finished Side or Finished Interior, not available in Foil.

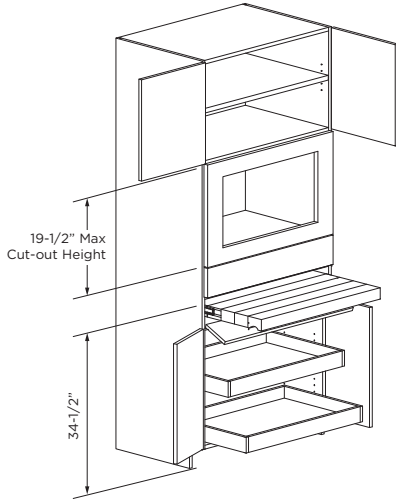

CABINET WIDTH	CUTOUT WIDTH		CUTOUT HEIGHT	
	Min.	Max.	Min.	Max.
27"	21"	24"	12-1/2"	19-1/2"
30"	24"	27"	12-1/2"	19-1/2"
33"	27"	30"	12-1/2"	19-1/2"
36"	30"	33"	12-1/2"	19-1/2"

84" HIGH	A	B	C	D	E	F	G
21" High Top Section, 1 Adjustable Shelf							
ETMB2784	4381	4551	4721	4890	5161	5330	5534
ETMB3084	4497	4672	4848	5023	5304	5479	5689
ETMB3384	4599	4779	4960	5141	5429	5609	5825
ETMB3684	4705	4888	5075	5263	5558	5742	5965

90" HIGH	A	B	C	D	E	F	G
27" High Top Section, 1 Adjustable Shelf							
ETMB2790	4573	4752	4931	5111	5397	5576	5791
ETMB3090	4687	4872	5057	5242	5537	5721	5944
ETMB3390	4790	4979	5170	5359	5664	5853	6081
ETMB3690	4897	5089	5286	5479	5794	5987	6221

93" HIGH	A	B	C	D	E	F	G
30" High Top Section, 1 Adjustable Shelf							
ETMB2793	4763	4951	5141	5329	5631	5819	6045
ETMB3093	4876	5071	5265	5460	5770	5964	6197
ETMB3393	4979	5178	5378	5577	5896	6095	6335
ETMB3693	5088	5289	5496	5702	6027	6234	6480

96" HIGH	A	B	C	D	E	F	G
33" High Top Section, 2 Adjustable Shelves							
ETMB2796	4953	5152	5350	5548	5864	6062	6301
ETMB3096	5070	5271	5475	5678	6005	6208	6452
ETMB3396	5170	5379	5588	5797	6131	6340	6590
ETMB3696	5276	5491	5707	5923	6263	6479	6736

102" HIGH	A	B	C	D	E	F	G
39" High Top Section, 2 Adjustable Shelves							
ETMB27102	5176	5386	5597	5804	6140	6347	6598
ETMB30102	5296	5512	5729	5941	6287	6504	6758
ETMB33102	5406	5627	5850	6072	6422	6644	6909
ETMB36102	5519	5745	5973	6201	6560	6788	7060

108" HIGH	A	B	C	D	E	F	G
45" High Top Section, 2 Adjustable Shelves							
ETMB27108	5412	5633	5856	6074	6429	6647	6912
ETMB30108	5538	5766	5995	6219	6584	6813	7080
ETMB33108	5654	5887	6122	6357	6726	6961	7240
ETMB36108	5773	6012	6253	6493	6872	7112	7399

120" HIGH	A	B	C	D	E	F	G
57" High Top Section, 3 Adjustable Shelves							
ETMB27120	5918	6164	6412	6654	7049	7291	7586
ETMB30120	6059	6312	6566	6815	7221	7476	7774
ETMB33120	6188	6447	6708	6969	7380	7640	7951
ETMB36120	6320	6586	6853	7121	7542	7809	8128

**DESIGN NOTES:** Height modifications affect the upper section only unless otherwise specified.



**TABLE OF CONTENTS**

**ELAN CLOSET/FURNITURE CABINETS.....E900-1 THRU E900-16**

Closet Tower Cabinets ..... E900-1 thru E900-11

Closet Base Cabinets..... E900-12 thru E900-14

Closet Panels/Shelves..... E900-15

Closet Accessories ..... E900-16

Mudroom.....E900-17 thru E900-18



# ELAN CLOSET/FURNITURE CABINETS

## CLOSET TOWER - STYLE A

- Subtoe is Shipped Attached Unless Specified "Ship Subtoe Loose"
- Doors Prepared For Glass (Clear Glass Included)
- Finished Interior
- Cabinets over 96" High Not Available in Foil

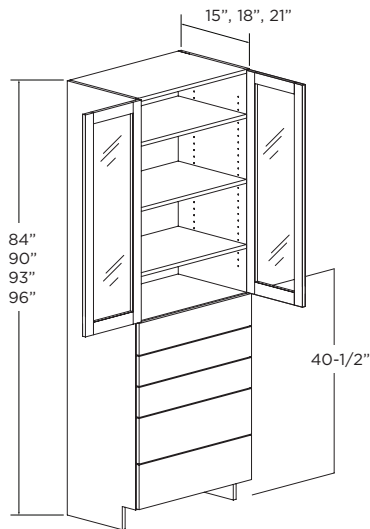

84" HIGH	A	B	C	D	E	F	G
<b>15" DEEP</b>	3 Adjustable Shelves, 5 Drawers						
ECT248415A	3569	3747	3926	4105	4390	4569	4783
ECT308415A	4112	4317	4524	4729	5058	5264	5511
ECT368415A	4541	4768	4996	5223	5586	5813	6085
<b>18" DEEP</b>							
ECT248418A	3792	3981	4172	4361	4665	4854	5082
ECT308418A	4333	4549	4767	4983	5330	5547	5807
ECT368418A	4763	5001	5240	5478	5859	6097	6383
<b>21" DEEP</b>							
ECT248421A	4014	4214	4416	4617	4938	5138	5379
ECT308421A	4555	4782	5011	5239	5603	5831	6104
ECT368421A	4984	5233	5483	5732	6131	6380	6679

90" HIGH	A	B	C	D	E	F	G
<b>15" DEEP</b>	3 Adjustable Shelves, 5 Drawers						
ECT249015A	3761	3949	4138	4326	4627	4815	5040
ECT309015A	4316	4531	4748	4964	5309	5525	5784
ECT369015A	4732	4968	5206	5442	5821	6057	6341
<b>18" DEEP</b>							
ECT249018A	3983	4182	4382	4581	4900	5099	5338
ECT309018A	4537	4763	4991	5218	5581	5808	6080
ECT369018A	4956	5203	5452	5700	6096	6344	6642
<b>21" DEEP</b>							
ECT249021A	4205	4415	4626	4836	5173	5383	5635
ECT309021A	4760	4998	5236	5474	5855	6093	6379
ECT369021A	5177	5435	5695	5954	6368	6627	6938

93" HIGH	A	B	C	D	E	F	G
<b>15" DEEP</b>	4 Adjustable Shelves, 5 Drawers						
ECT249315A	3952	4149	4348	4545	4861	5059	5296
ECT309315A	4507	4732	4958	5184	5544	5769	6040
ECT369315A	4923	5169	5416	5662	6056	6302	6597
<b>18" DEEP</b>							
ECT249318A	4173	4381	4591	4799	5133	5342	5592
ECT309318A	4729	4965	5202	5439	5817	6054	6337
ECT369318A	5145	5402	5660	5917	6329	6586	6895
<b>21" DEEP</b>							
ECT249321A	4398	4617	4838	5058	5410	5630	5894
ECT309321A	4952	5199	5448	5695	6091	6339	6636
ECT369321A	5369	5637	5906	6175	6604	6873	7195

96" HIGH	A	B	C	D	E	F	G
<b>15" DEEP</b>	4 Adjustable Shelves, 5 Drawers						
ECT249615A	4143	4350	4558	4765	5096	5304	5552
ECT309615A	4697	4931	5167	5402	5778	6013	6294
ECT369615A	5116	5371	5628	5884	6293	6549	6856
<b>18" DEEP</b>							
ECT249618A	4365	4583	4802	5020	5369	5588	5850
ECT309618A	4920	5165	5412	5658	6052	6298	6593
ECT369618A	5337	5603	5871	6138	6565	6832	7152
<b>21" DEEP</b>							
ECT249621A	4587	4816	5046	5276	5643	5872	6147
ECT309621A	5143	5400	5658	5915	6326	6584	6892
ECT369621A	5560	5837	6116	6394	6839	7117	7451



# ELAN CLOSET/FURNITURE CABINETS

## CLOSET TOWER - STYLE B

- Subtoe is Shipped Attached Unless Specified "Ship Subtoe Loose"
- Doors Prepared For Glass (Clear Glass Included)
- Finished Interior
- Top Drawer with solid wood, adjustable Organizer
- Cabinets over 96" High Not Available in Foil

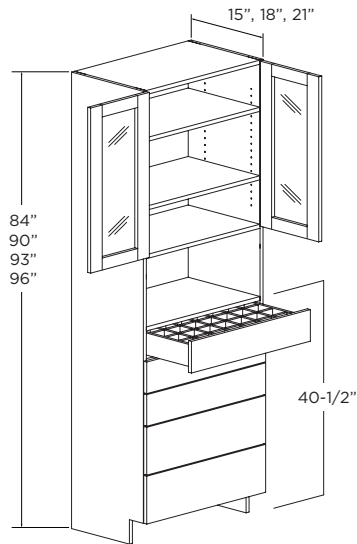

84" HIGH	A	B	C	D	E	F	G
<b>15" DEEP</b>	2 Adjustable Shelves, 5 Drawers						
ECT248415B	4084	4288	4493	4697	5024	5228	5473
ECT308415B	4654	4886	5120	5353	5725	5958	6237
ECT368415B	5104	5359	5615	5870	6278	6534	6840
<b>18" DEEP</b>	2 Adjustable Shelves, 5 Drawers						
ECT248418B	4320	4535	4752	4968	5314	5530	5789
ECT308418B	4887	5131	5376	5621	6012	6256	6549
ECT368418B	5339	5605	5873	6140	6567	6834	7155
<b>21" DEEP</b>	2 Adjustable Shelves, 5 Drawers						
ECT248421B	4552	4779	5008	5235	5599	5827	6100
ECT308421B	5120	5375	5632	5888	6298	6554	6861
ECT368421B	5571	5849	6129	6407	6853	7131	7466

90" HIGH	A	B	C	D	E	F	G
<b>15" DEEP</b>	2 Adjustable Shelves, 5 Drawers						
ECT249015B	4286	4500	4715	4929	5272	5487	5744
ECT309015B	4868	5111	5355	5599	5988	6232	6524
ECT369015B	5305	5570	5836	6101	6526	6791	7109
<b>18" DEEP</b>	2 Adjustable Shelves, 5 Drawers						
ECT249018B	4519	4744	4971	5197	5559	5785	6056
ECT309018B	5100	5354	5610	5865	6273	6528	6834
ECT369018B	5539	5815	6093	6370	6813	7090	7423
<b>21" DEEP</b>	2 Adjustable Shelves, 5 Drawers						
ECT249021B	4753	4990	5229	5466	5847	6084	6370
ECT309021B	5335	5601	5869	6136	6563	6829	7149
ECT369021B	5772	6060	6350	6638	7100	7389	7735

93" HIGH	A	B	C	D	E	F	G
<b>15" DEEP</b>	3 Adjustable Shelves, 5 Drawers						
ECT249315B	4487	4711	4936	5161	5520	5744	6013
ECT309315B	5069	5322	5576	5830	6235	6489	6793
ECT369315B	5505	5780	6056	6331	6772	7047	7377
<b>18" DEEP</b>	3 Adjustable Shelves, 5 Drawers						
ECT249318B	4720	4955	5192	5428	5806	6042	6325
ECT309318B	5301	5566	5832	6097	6521	6786	7104
ECT369318B	5740	6026	6314	6601	7061	7348	7692
<b>21" DEEP</b>	3 Adjustable Shelves, 5 Drawers						
ECT249321B	4955	5202	5451	5699	6095	6343	6640
ECT309321B	5537	5813	6091	6368	6811	7088	7420
ECT369321B	5973	6271	6571	6869	7347	7646	8004

96" HIGH	A	B	C	D	E	F	G
<b>15" DEEP</b>	3 Adjustable Shelves, 5 Drawers						
ECT249615B	4686	4920	5155	5389	5764	5999	6280
ECT309615B	5268	5531	5795	6059	6480	6744	7060
ECT369615B	5707	5992	6278	6564	7020	7305	7648
<b>18" DEEP</b>	3 Adjustable Shelves, 5 Drawers						
ECT249618B	4921	5167	5414	5660	6053	6299	6595
ECT309618B	5502	5777	6053	6328	6768	7043	7373
ECT369618B	5939	6235	6533	6830	7305	7602	7959
<b>21" DEEP</b>	3 Adjustable Shelves, 5 Drawers						
ECT249621B	5154	5411	5670	5928	6340	6598	6907
ECT309621B	5736	6022	6310	6597	7056	7343	7687
ECT369621B	6174	6482	6792	7101	7595	7903	8274

# ELAN CLOSET/FURNITURE CABINETS

## CLOSET TOWER - STYLE C

- Subtoe is Shipped Attached Unless Specified "Ship Subtoe Loose"
- Finished Interior
- Cabinets over 96" High Not Available in Foil

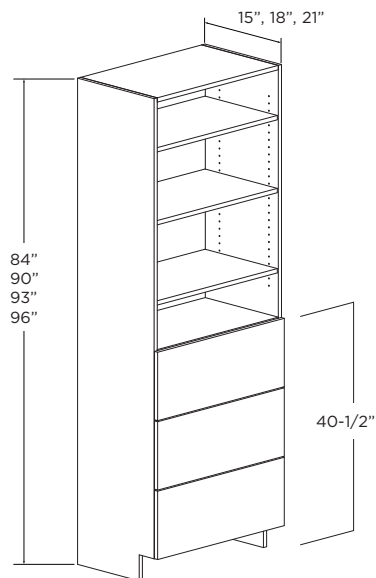

84" HIGH	A	B	C	D	E	F	G
<b>15" DEEP</b>	3 Adjustable Shelves, 3 Drawers						
ECT248415C	2607	2737	2868	2999	3207	3337	3494
ECT308415C	3077	3230	3385	3539	3785	3939	4124
ECT368415C	3502	3677	3853	4028	4308	4483	4693
<b>18" DEEP</b>							
ECT248418C	2844	2986	3129	3271	3499	3641	3811
ECT308418C	3313	3478	3645	3810	4075	4241	4440
ECT368418C	3739	3925	4113	4300	4599	4786	5011
<b>21" DEEP</b>							
ECT248421C	3080	3234	3388	3542	3789	3943	4128
ECT308421C	3552	3729	3908	4085	4369	4547	4760
ECT368421C	3977	4175	4375	4574	4892	5091	5330

90" HIGH	A	B	C	D	E	F	G
<b>15" DEEP</b>	3 Adjustable Shelves, 3 Drawers						
ECT249015C	2810	2950	3091	3232	3457	3597	3766
ECT309015C	3281	3445	3610	3774	4036	4200	4397
ECT369015C	3704	3889	4075	4260	4556	4742	4964
<b>18" DEEP</b>							
ECT249018C	3049	3201	3354	3507	3751	3903	4086
ECT309018C	3517	3692	3869	4045	4326	4502	4713
ECT369018C	3943	4140	4338	4535	4850	5048	5284
<b>21" DEEP</b>							
ECT249021C	3284	3448	3613	3777	4040	4204	4401
ECT309021C	3755	3942	4131	4319	4619	4807	5032
ECT369021C	4180	4389	4598	4807	5142	5351	5602

93" HIGH	A	B	C	D	E	F	G
<b>15" DEEP</b>	4 Adjustable Shelves, 3 Drawers						
ECT249315C	3014	3164	3316	3467	3708	3858	4039
ECT309315C	3482	3656	3831	4005	4283	4457	4666
ECT369315C	3909	4104	4300	4496	4809	5004	5239
<b>18" DEEP</b>							
ECT249318C	3252	3414	3578	3740	4000	4163	4358
ECT309318C	3720	3906	4092	4278	4576	4762	4985
ECT369318C	4146	4353	4561	4768	5100	5307	5556
<b>21" DEEP</b>							
ECT249321C	3487	3661	3836	4011	4290	4464	4673
ECT309321C	3956	4153	4352	4550	4866	5064	5302
ECT369321C	4381	4600	4820	5039	5389	5608	5871

96" HIGH	A	B	C	D	E	F	G
<b>15" DEEP</b>	4 Adjustable Shelves, 3 Drawers						
ECT249615C	3218	3378	3540	3701	3959	4120	4313
ECT309615C	3688	3872	4057	4242	4537	4721	4942
ECT369615C	4112	4317	4524	4729	5058	5264	5511
<b>18" DEEP</b>							
ECT249618C	3456	3628	3802	3975	4251	4424	4632
ECT309618C	3924	4120	4317	4513	4827	5023	5259
ECT369618C	4350	4567	4785	5003	5351	5568	5829
<b>21" DEEP</b>							
ECT249621C	3693	3877	4063	4247	4543	4728	4949
ECT309621C	4162	4370	4579	4787	5120	5328	5578
ECT369621C	4587	4816	5046	5276	5643	5872	6147

# ELAN CLOSET/FURNITURE CABINETS

## CLOSET TOWER - STYLE D

- Subtoe is Shipped Attached Unless Specified "Ship Subtoe Loose"
- Finished Interior
- Single Long Hanging Area
- Specify Rod Color: Satin Nickel or Oiled Rubbed Bronze
- Cabinets over 96" High Not Available in Foil

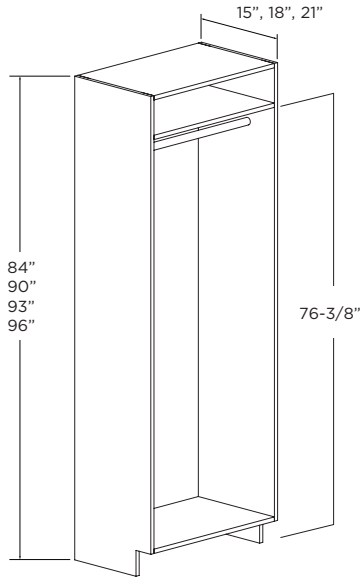

84" HIGH	A	B	C	D	E	F	G
<b>15" DEEP</b>	No Shelf						
ECT248415D	1734	1734	1734	1734	1734	1734	1734
ECT308415D	2042	2042	2042	2042	2042	2042	2042
ECT368415D	2302	2302	2302	2302	2302	2302	2302
<b>18" DEEP</b>							
ECT248418D	1986	1986	1986	1986	1986	1986	1986
ECT308418D	2294	2294	2294	2294	2294	2294	2294
ECT368418D	2551	2551	2551	2551	2551	2551	2551

90" HIGH	A	B	C	D	E	F	G
<b>15" DEEP</b>	No Shelf						
ECT249015D	1954	1954	1954	1954	1954	1954	1954
ECT309015D	2258	2258	2258	2258	2258	2258	2258
ECT369015D	2517	2517	2517	2517	2517	2517	2517
<b>18" DEEP</b>							
ECT249018D	2202	2202	2202	2202	2202	2202	2202
ECT309018D	2511	2511	2511	2511	2511	2511	2511
ECT369018D	2770	2770	2770	2770	2770	2770	2770

93" HIGH	A	B	C	D	E	F	G
<b>15" DEEP</b>	1 Adjustable Shelf						
ECT249315D	2169	2169	2169	2169	2169	2169	2169
ECT309315D	2474	2474	2474	2474	2474	2474	2474
ECT369315D	2734	2734	2734	2734	2734	2734	2734
<b>18" DEEP</b>							
ECT249318D	2419	2419	2419	2419	2419	2419	2419
ECT309318D	2726	2726	2726	2726	2726	2726	2726
ECT369318D	2987	2987	2987	2987	2987	2987	2987

96" HIGH	A	B	C	D	E	F	G
<b>15" DEEP</b>	1 Adjustable Shelf						
ECT249615D	2385	2385	2385	2385	2385	2385	2385
ECT309615D	2691	2691	2691	2691	2691	2691	2691
ECT369615D	2950	2950	2950	2950	2950	2950	2950
<b>18" DEEP</b>							
ECT249618D	2635	2635	2635	2635	2635	2635	2635
ECT309618D	2943	2943	2943	2943	2943	2943	2943
ECT369618D	3203	3203	3203	3203	3203	3203	3203

# ELAN CLOSET/FURNITURE CABINETS

## CLOSET TOWER - STYLE E

- Subtoe is Shipped Attached Unless Specified "Ship Subtoe Loose"
- Finished Interior
- Single Short Hanging Area
- Specify Rod Color: Satin Nickel or Oiled Rubbed Bronze
- Pull Out Hanging Area for Pants
- 2-Adjustable Shelves Bottom Right
- Cabinets over 96" High Not Available in Foil

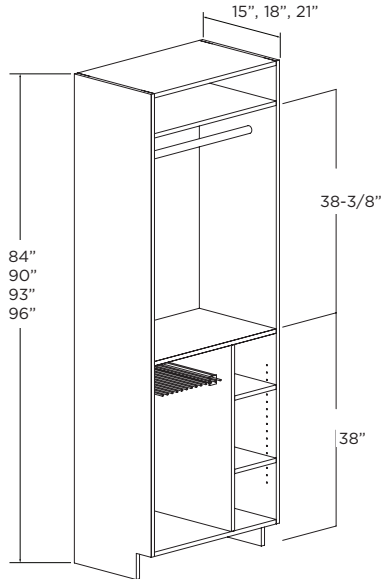

84" HIGH	PRICE	90" HIGH	PRICE
<b>15" DEEP</b>	No Shelf	<b>15" DEEP</b>	No Shelf
ECT308415E	2285	ECT309015E	2484
ECT368415E	2525	ECT369015E	2726
<b>18" DEEP</b>	No Shelf	<b>18" DEEP</b>	No Shelf
ECT308418E	2518	ECT309018E	2718
ECT368418E	2757	ECT369018E	2959

93" HIGH	PRICE	96" HIGH	PRICE
<b>15" DEEP</b>	1 Adj. Shelf (Top)	<b>15" DEEP</b>	1 Adj. Shelf (Top)
ECT309315E	2685	ECT309615E	2886
ECT369315E	2925	ECT369615E	3126
<b>18" DEEP</b>	1 Adj. Shelf (Top)	<b>18" DEEP</b>	1 Adj. Shelf (Top)
ECT309318E	2919	ECT309618E	3119
ECT369318E	3159	ECT369618E	3359

## CLOSET TOWER - STYLE F

- Subtoe is Shipped Attached Unless Specified "Ship Subtoe Loose"
- Finished Interior
- Single Short Hanging Area
- Specify Rod Color: Satin Nickel or Oiled Rubbed Bronze
- 4 Adj. Slanted Shoe Shelves
- Cabinets over 96" High Not Available in Foil

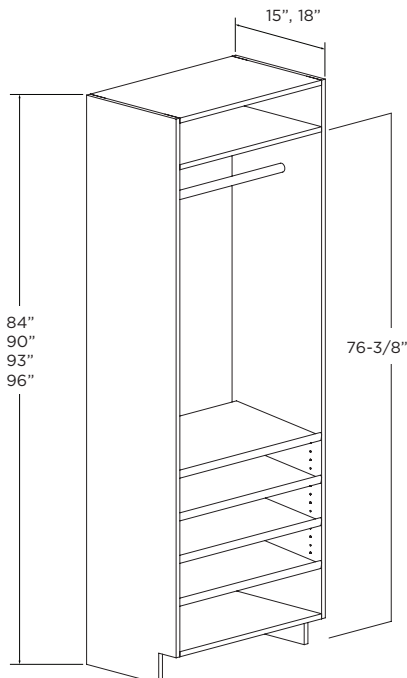

84" HIGH	PRICE	90" HIGH	PRICE
<b>15" DEEP</b>	No Shelf	<b>15" DEEP</b>	No Shelf
ECT248415F	2036	ECT249015F	2217
ECT308415F	2431	ECT309015F	2614
ECT368415F	2798	ECT369015F	2979
<b>18" DEEP</b>	No Shelf	<b>18" DEEP</b>	No Shelf
ECT248418F	2248	ECT249018F	2429
ECT308418F	2642	ECT309018F	2825
ECT368418F	3010	ECT369018F	3191

93" HIGH	PRICE	96" HIGH	PRICE
<b>15" DEEP</b>	1 Adj. Shelf (Top)	<b>15" DEEP</b>	1 Adj. Shelf (Top)
ECT249315F	2400	ECT249615F	2581
ECT309315F	2795	ECT309615F	2976
ECT369315F	3161	ECT369615F	3342
<b>18" DEEP</b>	1 Adj. Shelf (Top)	<b>18" DEEP</b>	1 Adj. Shelf (Top)
ECT249318F	2612	ECT249618F	2793
ECT309318F	3006	ECT309618F	3187
ECT369318F	3373	ECT369618F	3554

# ELAN CLOSET/FURNITURE CABINETS

## CLOSET TOWER - STYLE G

- Subtoe is Shipped Attached Unless Specified "Ship Subtoe Loose"
- Finished Interior
- 2-Equal Sized Hanging Areas
- Specify Rod Color: Satin Nickel or Oiled Rubbed Bronze
- Cabinets over 96" High Not Available in Foil

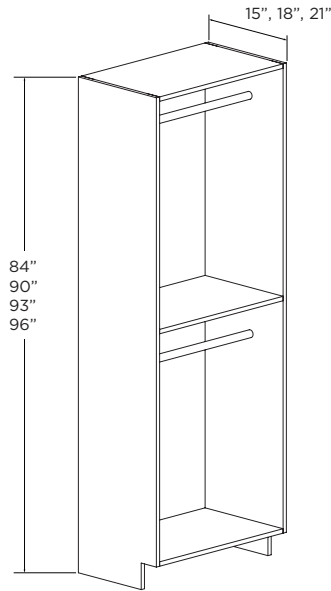

84" HIGH	PRICE
<b>15" DEEP</b>	No Shelf
ECT248415G	1617
ECT308415G	1905
ECT368415G	2147
<b>18" DEEP</b>	No Shelf
ECT248418G	1853
ECT308418G	2139
ECT368418G	2380

90" HIGH	PRICE
<b>15" DEEP</b>	No Shelf
ECT249015G	1822
ECT309015G	2106
ECT369015G	2348
<b>18" DEEP</b>	No Shelf
ECT249018G	2054
ECT309018G	2341
ECT369018G	2583

93" HIGH	PRICE
<b>15" DEEP</b>	No Shelf
ECT249315G	2023
ECT309315G	2307
ECT369315G	2550
<b>18" DEEP</b>	No Shelf
ECT249318G	2256
ECT309318G	2543
ECT369318G	2786

96" HIGH	PRICE
<b>15" DEEP</b>	No Shelf
ECT249615G	2224
ECT309615G	2509
ECT369615G	2751
<b>18" DEEP</b>	No Shelf
ECT249618G	2457
ECT309618G	2745
ECT369618G	2987

## CLOSET TOWER - STYLE H

- Subtoe is Shipped Attached Unless Specified "Ship Subtoe Loose"
- Finished Interior
- 2-Equal Sized Areas
- Cabinets over 96" High Not Available in Foil

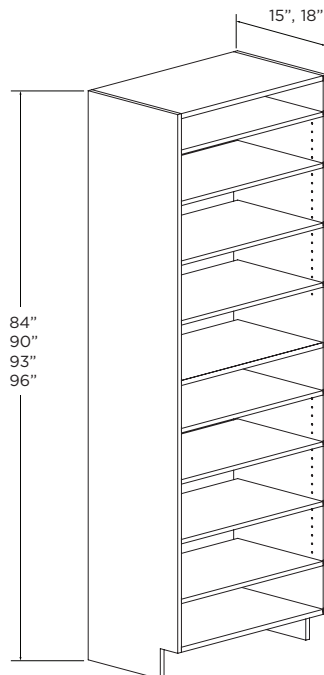

84" HIGH	PRICE
<b>15" DEEP</b>	8 Adj. Shelves
ECT248415H	2424
ECT308415H	2894
ECT368415H	3330
<b>18" DEEP</b>	8 Adj. Shelves
ECT248418H	2676
ECT308418H	3000
ECT368418H	3145

90" HIGH	PRICE
<b>15" DEEP</b>	8 Adj. Shelves
ECT249015H	2639
ECT309015H	3111
ECT369015H	3546
<b>18" DEEP</b>	8 Adj. Shelves
ECT249018H	2891
ECT309018H	3363
ECT369018H	3798

93" HIGH	PRICE
<b>15" DEEP</b>	10 Adj. Shelves
ECT249315H	2857
ECT309315H	3326
ECT369315H	3763
<b>18" DEEP</b>	10 Adj. Shelves
ECT249318H	3109
ECT309318H	3578
ECT369318H	4015

96" HIGH	PRICE
<b>15" DEEP</b>	10 Adj. Shelves
ECT249615H	3073
ECT309615H	3542
ECT369615H	3978
<b>18" DEEP</b>	10 Adj. Shelves
ECT249618H	3325
ECT309618H	3794
ECT369618H	4230

# ELAN CLOSET/FURNITURE CABINETS

## CLOSET TOWER - STYLE I

- Subtoe is Shipped Attached Unless Specified "Ship Subtoe Loose"
- Finished Interior
- 4 Adjustable Slanted Shoe Shelves
- Cabinets over 96" High Not Available in Foil

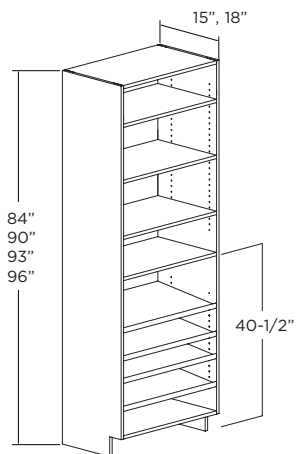

84" HIGH	PRICE
<b>15" DEEP</b>	3 Adj. Shelves
ECT248415I	2490
ECT308415I	2973
ECT368415I	3421
<b>18" DEEP</b>	3 Adj. Shelves
ECT248418I	2749
ECT308418I	3231
ECT368418I	3680

90" HIGH	PRICE
<b>15" DEEP</b>	3 Adj. Shelves
ECT249015I	2711
ECT309015I	3196
ECT369015I	3642
<b>18" DEEP</b>	3 Adj. Shelves
ECT249018I	2970
ECT309018I	3455
ECT369018I	3901

93" HIGH	PRICE
<b>15" DEEP</b>	4 Adj. Shelves
ECT249315I	2935
ECT309315I	3417
ECT369315I	3865
<b>18" DEEP</b>	4 Adj. Shelves
ECT249318I	3194
ECT309318I	3676
ECT369318I	4124

96" HIGH	PRICE
<b>15" DEEP</b>	4 Adj. Shelves
ECT249615I	3156
ECT309615I	3638
ECT369615I	4086
<b>18" DEEP</b>	4 Adj. Shelves
ECT249618I	3415
ECT309618I	3897
ECT369618I	4346

## CLOSET TOWER - STYLE J

- Subtoe is Shipped Attached Unless Specified "Ship Subtoe Loose"
- Finished Interior
- 1 Fixed Vertical Divider Top Section
- 1 Drawer with solid wood, adjustable Organizer
- Shoe Cubbies (24" Wide has 12 Cubbies)
- Shoe Cubbies (30", 36", Wide has 16 Cubbies)
- Cabinets over 96" High Not Available in Foil

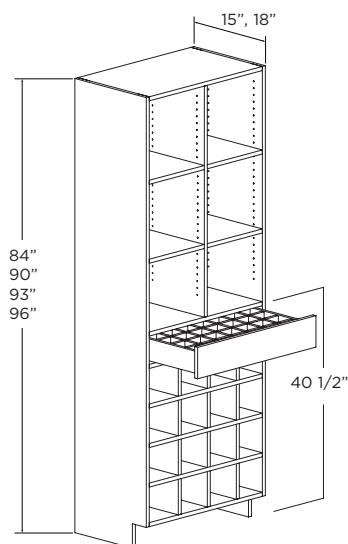

84" HIGH	A	B	C	D	E	F	G
<b>15" DEEP</b>	6 Adjustable Shelves						
ECT248415J	3505	3680	3856	4031	4312	4487	4697
ECT308415J	3869	4062	4256	4450	4759	4953	5185
ECT368415J	4205	4415	4626	4836	5173	5383	5635
<b>18" DEEP</b>	6 Adjustable Shelves						
ECT248418J	3700	3884	4070	4255	4551	4736	4958
ECT308418J	4061	4264	4468	4671	4996	5199	5442
ECT368418J	4400	4619	4840	5060	5412	5632	5896

90" HIGH	A	B	C	D	E	F	G
<b>15" DEEP</b>	6 Adjustable Shelves						
ECT249015J	3671	3854	4039	4222	4516	4699	4920
ECT309015J	4035	4236	4439	4641	4964	5165	5407
ECT369015J	4372	4590	4810	5028	5378	5597	5859
<b>18" DEEP</b>	6 Adjustable Shelves						
ECT249018J	3864	4057	4251	4444	4753	4946	5178
ECT309018J	4227	4438	4650	4862	5200	5411	5665
ECT369018J	4564	4792	5021	5249	5614	5842	6116

93" HIGH	A	B	C	D	E	F	G
<b>15" DEEP</b>	8 Adjustable Shelves						
ECT249315J	3839	4030	4223	4415	4722	4914	5145
ECT309315J	4202	4412	4623	4833	5169	5379	5631
ECT369315J	4538	4764	4992	5219	5582	5809	6081
<b>18" DEEP</b>	8 Adjustable Shelves						
ECT249318J	4030	4231	4433	4635	4957	5159	5401
ECT309318J	4393	4612	4833	5052	5404	5624	5887
ECT369318J	4731	4967	5205	5441	5820	6056	6340

96" HIGH	A	B	C	D	E	F	G
<b>15" DEEP</b>	8 Adjustable Shelves						
ECT249615J	4004	4204	4405	4605	4925	5126	5366
ECT309615J	4368	4586	4805	5024	5373	5592	5854
ECT369615J	4704	4939	5175	5410	5786	6022	6304
<b>18" DEEP</b>	8 Adjustable Shelves						
ECT249618J	4197	4406	4617	4827	5163	5373	5624
ECT309618J	4561	4789	5018	5246	5611	5839	6112
ECT369618J	4898	5142	5388	5633	6025	6270	6564

# ELAN CLOSET/FURNITURE CABINETS

## CLOSET TOWER - STYLE L

- Subtoe is Shipped Attached Unless Specified "Ship Subtoe Loose"
- Specify Hinge (L or R)
- Finished Interior
- Decrease Depth Not Available
- Cabinets over 96" High Not Available in Foil
- White wire hamper

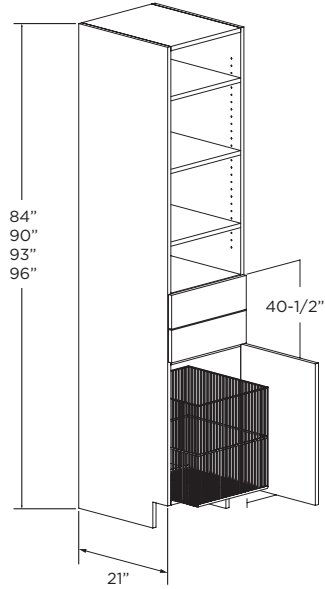

ITEM	A	B	C	D	E	F	G
2 Drawers, 3 Adjustable Shelves, 1 Pull Out Hamper							
ECT188421L	2972	3120	3270	3418	3656	3805	3983
ECT189021L	3172	3330	3490	3648	3902	4061	4251
2 Drawers, 4 Adjustable Shelves, 1 Pull Out Hamper							
ECT189321L	3372	3540	3710	3878	4148	4317	4519
ECT189621L	3574	3752	3932	4111	4397	4575	4790

## CLOSET TOWER - STYLE M

- Subtoe is Shipped Attached Unless Specified "Ship Subtoe Loose"
- Finished Interior
- Decrease Depth Not Available
- Cabinets over 96" High Not Available in Foil

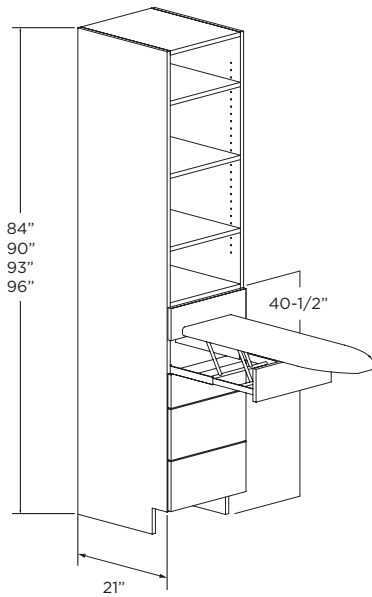

ITEM	A	B	C	D	E	F	G
4 Drawers, 3 Adjustable Shelves, 1 Pull Out Ironing Board							
ECT188421M	4990	5239	5489	5739	6138	6388	6687
ECT189021M	5363	5631	5900	6168	6597	6865	7187
4 Drawers, 4 Adjustable Shelves, 1 Pull Out Ironing Board							
ECT189321M	5590	5869	6149	6429	6876	7156	7491
ECT189621M	5818	6108	6400	6691	7157	7448	7797

# ELAN CLOSET/FURNITURE CABINETS

## CLOSET TOWER - STYLE N

- Subtoe is Shipped Attached Unless Specified "Ship Subtoe Loose"
- Finished Interior
- Cabinets over 96" High Not Available in Foil

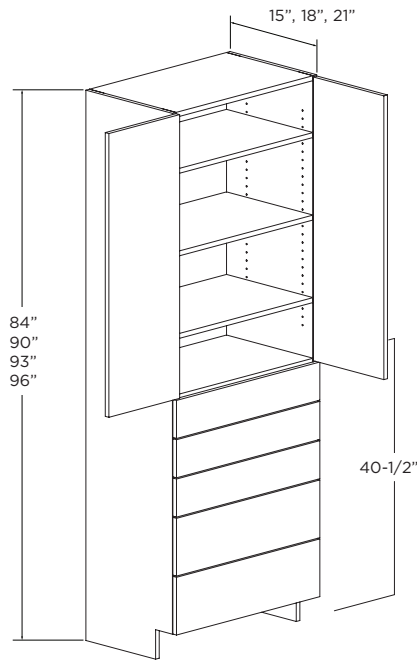

84" HIGH	A	B	C	D	E	F	G
<b>15" DEEP</b>	3 Adjustable Shelves, 5 Drawers						
ECT248415N	3569	3747	3926	4105	4390	4569	4783
ECT308415N	4112	4317	4524	4729	5058	5264	5511
ECT368415N	4541	4768	4996	5223	5586	5813	6085
<b>18" DEEP</b>	3 Adjustable Shelves, 5 Drawers						
ECT248418N	3792	3981	4172	4361	4665	4854	5082
ECT308418N	4333	4549	4767	4983	5330	5547	5807
ECT368418N	4763	5001	5240	5478	5859	6097	6383
<b>21" DEEP</b>	3 Adjustable Shelves, 5 Drawers						
ECT248421N	4014	4214	4416	4617	4938	5138	5379
ECT308421N	4555	4782	5011	5239	5603	5831	6104
ECT368421N	4984	5233	5483	5732	6131	6380	6679

90" HIGH	A	B	C	D	E	F	G
<b>15" DEEP</b>	3 Adjustable Shelves, 5 Drawers						
ECT249015N	3761	3949	4138	4326	4627	4815	5040
ECT309015N	4316	4531	4748	4964	5309	5525	5784
ECT369015N	4732	4968	5206	5442	5821	6057	6341
<b>18" DEEP</b>	3 Adjustable Shelves, 5 Drawers						
ECT249018N	3983	4182	4382	4581	4900	5099	5338
ECT309018N	4537	4763	4991	5218	5581	5808	6080
ECT369018N	4956	5203	5452	5700	6096	6344	6642
<b>21" DEEP</b>	3 Adjustable Shelves, 5 Drawers						
ECT249021N	4205	4415	4626	4836	5173	5383	5635
ECT309021N	4760	4998	5236	5474	5855	6093	6379
ECT369021N	5177	5435	5695	5954	6368	6627	6938

93" HIGH	A	B	C	D	E	F	G
<b>15" DEEP</b>	4 Adjustable Shelves, 5 Drawers						
ECT249315N	3952	4149	4348	4545	4861	5059	5296
ECT309315N	4507	4732	4958	5184	5544	5769	6040
ECT369315N	4923	5169	5416	5662	6056	6302	6597
<b>18" DEEP</b>	4 Adjustable Shelves, 5 Drawers						
ECT249318N	4173	4381	4591	4799	5133	5342	5592
ECT309318N	4729	4965	5202	5439	5817	6054	6337
ECT369318N	5145	5402	5660	5917	6329	6586	6895
<b>21" DEEP</b>	4 Adjustable Shelves, 5 Drawers						
ECT249321N	4398	4617	4838	5058	5410	5630	5894
ECT309321N	4952	5199	5448	5695	6091	6339	6636
ECT369321N	5369	5637	5906	6175	6604	6873	7195

96" HIGH	A	B	C	D	E	F	G
<b>15" DEEP</b>	4 Adjustable Shelves, 5 Drawers						
ECT249615N	4143	4350	4558	4765	5096	5304	5552
ECT309615N	4697	4931	5167	5402	5778	6013	6294
ECT369615N	5116	5371	5628	5884	6293	6549	6856
<b>18" DEEP</b>	4 Adjustable Shelves, 5 Drawers						
ECT249618N	4365	4583	4802	5020	5369	5588	5850
ECT309618N	4920	5165	5412	5658	6052	6298	6593
ECT369618N	5337	5603	5871	6138	6565	6832	7152
<b>21" DEEP</b>	4 Adjustable Shelves, 5 Drawers						
ECT249621N	4587	4816	5046	5276	5643	5872	6147
ECT309621N	5143	5400	5658	5915	6326	6584	6892
ECT369621N	5560	5837	6116	6394	6839	7117	7451



# ELAN CLOSET/FURNITURE CABINETS

## CLOSET TOWER - STYLE O

- Subtoe is Shipped Attached Unless Specified "Ship Subtoe Loose"
- Finished Interior
- Top Drawer with solid wood, adjustable Organizer
- Cabinets over 96" High Not Available in Foil

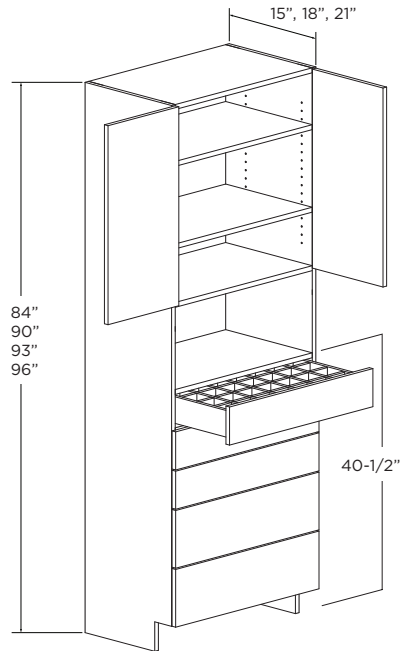

84" HIGH	A	B	C	D	E	F	G
<b>15" DEEP</b>	2 Adjustable Shelves, 5 Drawers						
ECT248415O	4038	4239	4442	4644	4967	5169	5411
ECT308415O	4652	4884	5118	5350	5722	5955	6234
ECT368415O	5139	5395	5653	5910	6321	6578	6887
<b>18" DEEP</b>							
ECT248418O	4290	4504	4719	4934	5277	5492	5749
ECT308418O	4902	5147	5393	5638	6030	6275	6569
ECT368418O	5389	5658	5928	6198	6629	6898	7222
<b>21" DEEP</b>							
ECT248421O	4541	4768	4996	5223	5586	5813	6085
ECT308421O	5153	5410	5669	5926	6339	6596	6906
ECT368421O	5640	5921	6204	6486	6938	7220	7558

90" HIGH	A	B	C	D	E	F	G
<b>15" DEEP</b>	2 Adjustable Shelves, 5 Drawers						
ECT249015O	4256	4468	4682	4895	5235	5448	5704
ECT309015O	4882	5126	5371	5615	6005	6249	6542
ECT369015O	5354	5621	5890	6158	6586	6854	7175
<b>18" DEEP</b>							
ECT249018O	4506	4731	4957	5182	5543	5768	6039
ECT309018O	5133	5389	5647	5903	6314	6571	6879
ECT369018O	5606	5886	6167	6447	6896	7176	7513
<b>21" DEEP</b>							
ECT249021O	4758	4995	5234	5472	5853	6091	6376
ECT309021O	5386	5655	5925	6194	6625	6895	7218
ECT369021O	5857	6149	6443	6736	7205	7497	7849

93" HIGH	A	B	C	D	E	F	G
<b>15" DEEP</b>	3 Adjustable Shelves, 5 Drawers						
ECT249315O	4471	4694	4919	5142	5500	5723	5992
ECT309315O	5099	5353	5609	5864	6272	6527	6833
ECT369315O	5570	5848	6127	6406	6852	7130	7464
<b>18" DEEP</b>							
ECT249318O	4721	4957	5194	5430	5807	6043	6327
ECT309318O	5351	5618	5887	6154	6582	6850	7171
ECT369318O	5821	6112	6404	6695	7160	7451	7801
<b>21" DEEP</b>							
ECT249321O	4976	5224	5474	5723	6121	6370	6668
ECT309321O	5602	5882	6163	6443	6891	7171	7507
ECT369321O	6075	6378	6683	6987	7473	7776	8141

96" HIGH	A	B	C	D	E	F	G
<b>15" DEEP</b>	3 Adjustable Shelves, 5 Drawers						
ECT249615O	4687	4921	5156	5391	5766	6000	6281
ECT309615O	5314	5579	5846	6112	6537	6802	7121
ECT369615O	5787	6076	6366	6656	7119	7408	7755
<b>18" DEEP</b>							
ECT249618O	4939	5185	5433	5680	6075	6322	6619
ECT309618O	5566	5844	6123	6401	6847	7125	7459
ECT369618O	6038	6339	6642	6944	7427	7729	8091
<b>21" DEEP</b>							
ECT249621O	5189	5448	5708	5968	6383	6642	6954
ECT309621O	5819	6109	6401	6692	7158	7449	7798
ECT369621O	6290	6604	6919	7234	7737	8052	8429

# ELAN CLOSET/FURNITURE CABINETS

## CLOSET BASE - STYLE A

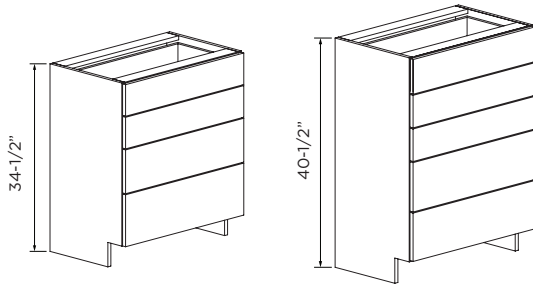

34-1/2" HIGH	A	B	C	D	E	F	G
<b>15" DEEP</b>	4 Drawers						
ECB243415A	1618	1698	1780	1861	1991	2072	2169
ECB303415A	1858	1950	2044	2137	2286	2379	2490
ECB363415A	1918	2013	2110	2206	2360	2456	2571
<b>18" DEEP</b>	4 Drawers						
ECB243418A	2157	2264	2373	2481	2654	2761	2891
ECB303418A	2218	2328	2440	2551	2729	2840	2973
ECB363418A	2454	2576	2700	2823	3019	3142	3289
<b>21" DEEP</b>	4 Drawers						
ECB243421A	2516	2641	2768	2894	3095	3221	3372
ECB303421A	2754	2891	3030	3168	3388	3526	3691
ECB363421A	2996	3145	3296	3446	3686	3835	4015

40-1/2" HIGH	A	B	C	D	E	F	G
<b>15" DEEP</b>	5 Drawers						
ECB244015A	2255	2367	2481	2594	2774	2887	3022
ECB304015A	2529	2655	2782	2909	3111	3238	3389
ECB364015A	2795	2934	3075	3215	3438	3578	3746
<b>18" DEEP</b>	5 Drawers						
ECB244018A	2555	2682	2811	2939	3143	3271	3424
ECB304018A	2829	2970	3112	3254	3480	3622	3791
ECB364018A	3092	3246	3402	3556	3804	3958	4144
<b>21" DEEP</b>	5 Drawers						
ECB244021A	2853	2995	3139	3281	3510	3652	3824
ECB304021A	3126	3282	3439	3595	3845	4002	4189
ECB364021A	3391	3560	3731	3900	4171	4341	4544

## CLOSET BASE - STYLE B

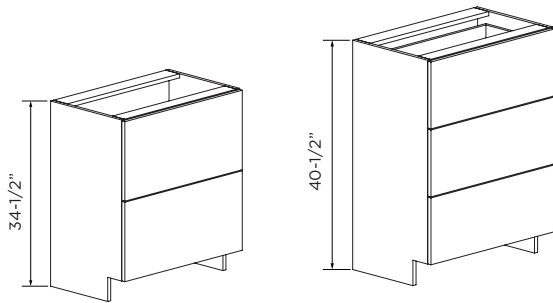

34-1/2" HIGH	A	B	C	D	E	F	G
<b>15" DEEP</b>	2 Drawers						
ECB243415B	1294	1358	1424	1489	1592	1657	1734
ECB303415B	1488	1562	1637	1712	1831	1905	1994
ECB363415B	1683	1767	1852	1936	2071	2155	2256
<b>18" DEEP</b>	2 Drawers						
ECB243418B	1538	1614	1692	1769	1892	1969	2061
ECB303418B	1733	1819	1907	1993	2132	2219	2323
ECB363418B	1928	2024	2121	2218	2372	2468	2584
<b>21" DEEP</b>	2 Drawers						
ECB243421B	1781	1870	1960	2049	2191	2280	2387
ECB303421B	1976	2074	2174	2273	2431	2530	2648
ECB363421B	2172	2280	2390	2498	2672	2781	2911

40-1/2" HIGH	A	B	C	D	E	F	G
<b>15" DEEP</b>	3 Drawers						
ECB244015B	1569	1647	1726	1805	1930	2009	2103
ECB304015B	1794	1883	1974	2064	2207	2297	2404
ECB364015B	2009	2109	2210	2311	2472	2572	2693
<b>18" DEEP</b>	3 Drawers						
ECB244018B	1815	1905	1997	2088	2233	2324	2433
ECB304018B	2039	2140	2243	2345	2508	2610	2733
ECB364018B	2253	2365	2479	2591	2772	2884	3020
<b>21" DEEP</b>	3 Drawers						
ECB244021B	2060	2162	2266	2369	2534	2637	2761
ECB304021B	2281	2395	2510	2624	2806	2920	3057
ECB364021B	2498	2622	2748	2873	3073	3198	3348

# ELAN CLOSET/FURNITURE CABINETS

## CLOSET BASE - STYLE C

- Adjustable, slanted shoe shelves
- Finished Interior

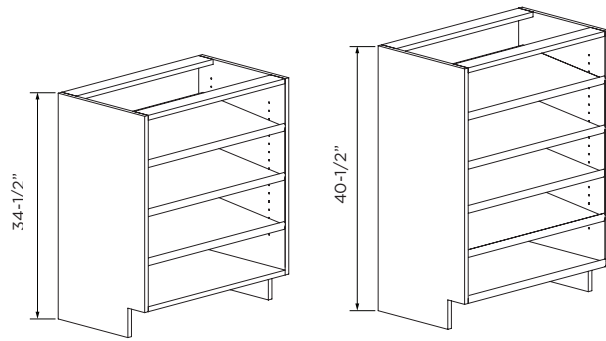

34-1/2" HIGH	A	B	C	D	E	F	G
<b>15" DEEP</b>	3 Slanted Shoe Shelves						
ECB243415C	1035	1035	1035	1035	1035	1035	1035
ECB303415C	1180	1180	1180	1180	1180	1180	1180
ECB363415C	1313	1313	1313	1313	1313	1313	1313
<b>18" DEEP</b>	3 Slanted Shoe Shelves						
ECB243418C	1296	1296	1296	1296	1296	1296	1296
ECB303418C	1440	1440	1440	1440	1440	1440	1440
ECB363418C	1573	1573	1573	1573	1573	1573	1573

40-1/2" HIGH	A	B	C	D	E	F	G
<b>15" DEEP</b>	4 Slanted Shoe Shelves						
ECB244015C	1164	1164	1164	1164	1164	1164	1164
ECB304015C	1324	1324	1324	1324	1324	1324	1324
ECB364015C	1470	1470	1470	1470	1470	1470	1470
<b>18" DEEP</b>	4 Slanted Shoe Shelves						
ECB244018C	1425	1425	1425	1425	1425	1425	1425
ECB304018C	1585	1585	1585	1585	1585	1585	1585
ECB364018C	1731	1731	1731	1731	1731	1731	1731

## CLOSET BASE - STYLE D

- Finished Interior

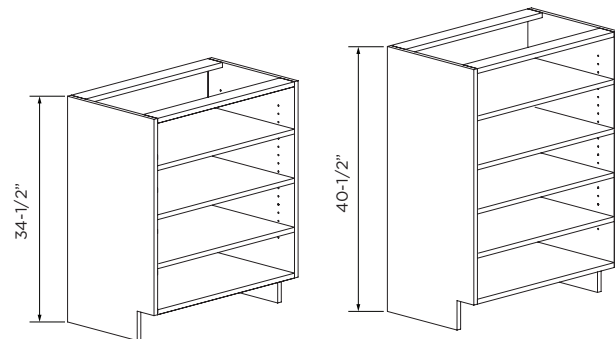

34-1/2" HIGH	A	B	C	D	E	F	G
<b>15" DEEP</b>	3 Adjustable Shelves						
ECB243415D	1021	1021	1021	1021	1021	1021	1021
ECB303415D	1165	1165	1165	1165	1165	1165	1165
ECB363415D	1296	1296	1296	1296	1296	1296	1296
<b>18" DEEP</b>	3 Adjustable Shelves						
ECB243418D	1279	1279	1279	1279	1279	1279	1279
ECB303418D	1421	1421	1421	1421	1421	1421	1421
ECB363418D	1553	1553	1553	1553	1553	1553	1553

40-1/2" HIGH	A	B	C	D	E	F	G
<b>15" DEEP</b>	4 Adjustable Shelves						
ECB244015D	1149	1149	1149	1149	1149	1149	1149
ECB304015D	1307	1307	1307	1307	1307	1307	1307
ECB364015D	1451	1451	1451	1451	1451	1451	1451
<b>18" DEEP</b>	4 Adjustable Shelves						
ECB244018D	1407	1407	1407	1407	1407	1407	1407
ECB304018D	1565	1565	1565	1565	1565	1565	1565
ECB364018D	1709	1709	1709	1709	1709	1709	1709

# ELAN CLOSET/FURNITURE CABINETS

## CLOSET BASE - STYLE E

- Finished Interior
- Top drawer with solid wood, adjustable Organizer

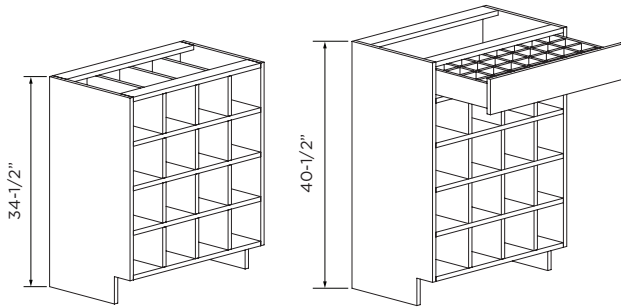

34-1/2" HIGH	A	B	C	D	E	F	G
<b>15" DEEP</b>	12 Shoe Cubbies						
ECB243415E	2494	2494	2494	2494	2494	2494	2494
	16 Shoe Cubbies						
ECB303415E	2620	2620	2620	2620	2620	2620	2620
ECB363415E	2735	2735	2735	2735	2735	2735	2735
<b>18" DEEP</b>	12 Shoe Cubbies						
ECB243418E	2718	2718	2718	2718	2718	2718	2718
	16 Shoe Cubbies						
ECB303418E	2843	2843	2843	2843	2843	2843	2843
ECB363418E	2958	2958	2958	2958	2958	2958	2958

40-1/2" HIGH	A	B	C	D	E	F	G
<b>15" DEEP</b>	12 Shoe Cubbies, 1 Drawer						
ECB244015E	2636	2767	2900	3032	3243	3375	3533
	16 Shoe Cubbies, 1 Drawer						
ECB304015E	2767	2905	3044	3183	3404	3542	3708
ECB364015E	2887	3031	3176	3321	3552	3696	3869
<b>18" DEEP</b>	12 Shoe Cubbies, 1 Drawer						
ECB244018E	2849	2991	3134	3277	3505	3647	3818
	16 Shoe Cubbies, 1 Drawer						
ECB304018E	2979	3127	3277	3426	3665	3814	3992
ECB364018E	3099	3253	3409	3564	3812	3967	4153

## CLOSET BASE - STYLE G

- Specify Hinge (L or R)
- Decrease Depth Not Available
- White wire hamper
- Finished Interior

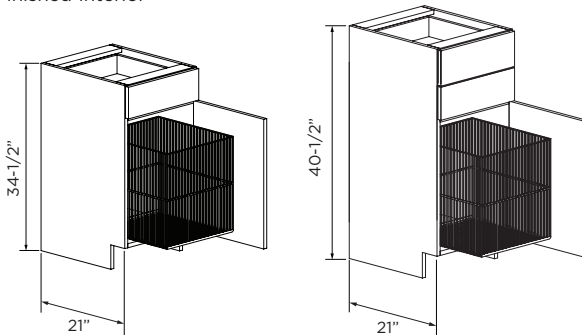

34-1/2" HIGH	A	B	C	D	E	F	G
	1 Drawer, 1 Pull Out Hamper						
ECB183421G	1015	1065	1117	1168	1249	1300	1361

40-1/2" HIGH	A	B	C	D	E	F	G
	2 Drawer, 1 Pull Out Hamper						
ECB184021G	1272	1335	1400	1463	1565	1629	1705

## CLOSET BASE - STYLE H

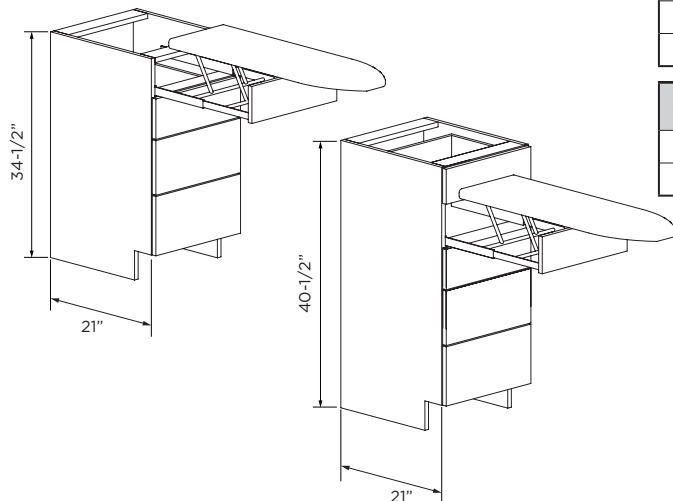

34-1/2" HIGH	A	B	C	D	E	F	G
	3 Drawers, 1 Pull Out Ironing Board						
ECB183421H	2075	2178	2283	2387	2553	2656	2781

40-1/2" HIGH	A	B	C	D	E	F	G
	4 Drawers, 1 Pull Out Ironing Board						
ECB184021H	2303	2418	2534	2649	2833	2948	3087

# ELAN CLOSET/FURNITURE CABINETS

## CLOSET END PANEL

- Finished Both Sides
- Both Long Edges Banded
- 3/4" Thick



ITEM	PRICE
ECEP 1584	311
ECEP 1590	351
ECEP 1593	361
ECEP 1596	368
ECEP 1884	427
ECEP 1890	473
ECEP 1893	485
ECEP 1896	495
ECEP 2184	543
ECEP 2190	594
ECEP 2193	608
ECEP 2196	622

**DESIGN NOTE:** This can be used for attaching to top of units to create open sections.

## CLOSET END PANEL ONE

- Finished Both Sides
- Both Long Edges Banded
- Line Boring One Side
- 3/4" Thick

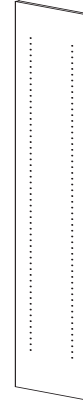

ITEM	PRICE
ECEP1 1584	365
ECEP1 1590	391
ECEP1 1593	404
ECEP1 1596	417
ECEP1 1884	437
ECEP1 1890	469
ECEP1 1893	485
ECEP1 1896	500
ECEP1 2184	511
ECEP1 2190	547
ECEP1 2193	565
ECEP1 2196	584

## CLOSET END PANEL TWO

- Finished Both Sides
- Both Long Edges Banded
- Line Boring Both Sides
- 3/4" Thick

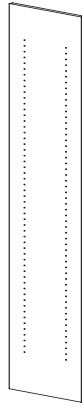

ITEM	PRICE
ECEP2 1584	389
ECEP2 1590	417
ECEP2 1593	431
ECEP2 1596	445
ECEP2 1884	467
ECEP2 1890	500
ECEP2 1893	516
ECEP2 1896	534
ECEP2 2184	544
ECEP2 2190	584
ECEP2 2193	603
ECEP2 2196	622

## CLOSET SLOTTED SHELF

- Finished Both Sides
- Front Edge Banded
- 1-15/16" Thick

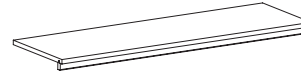
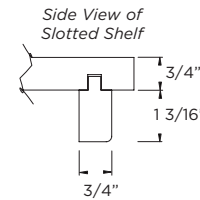

ITEM	PRICE	ACTUAL DEPTH
ECSS1524	119	14-13/16
ECSS1536	177	
ECSS1548	236	
ECSS1596	472	
ECSS1824	138	17-13/16
ECSS1836	207	
ECSS1848	275	
ECSS1896	550	
ECSS2124	157	20-13/16
ECSS2136	236	
ECSS2148	314	
ECSS2196	629	

## CLOSET SHELF CLEAT

- Finished Top, Bottom, Front

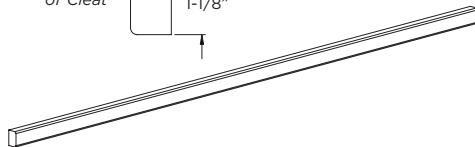
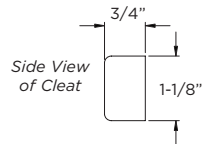

ITEM	PRICE
ECSC48	38
ECSC96	100

## CLOSET CORNER SHELVING

- Includes 6 shelf clips per shelf.
- For a corner application you will need 3 Closet End Panel One's.

ITEM	PRICE
ECS15	401
ECS18	
ECS21	

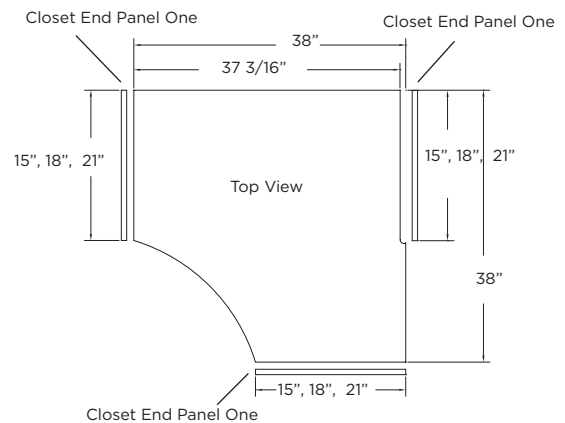

# ELAN CLOSET/FURNITURE CABINETS

## VALET ROD

- Satin Nickel or Oil Rubbed Bronze Finish
- Specify distance from floor

ITEM	PRICE
VR14-SN	59
VR14-ORB	

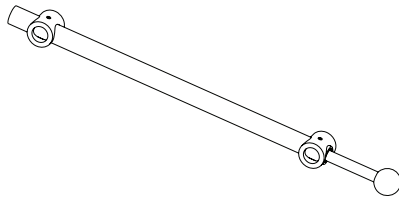

## PANTS RACK

- Chrome Finish
- Available 18" or 24" wide

ITEM	PRICE
PR18-CR	258
PR24-CR	

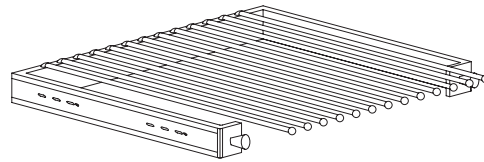

## TIE RACK

- Satin Nickel or Oil Rubbed Bronze Finish
- Specify distance from floor.

ITEM	PRICE
TR14-SN	74
TR14-ORB	

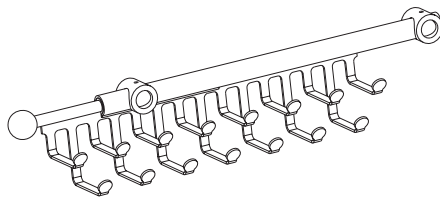

## Closet Rod Assembly

- Satin Nickel or Oil Rubbed Bronze Finish
- Available 4" or 8" wide.
- Includes 2 end supports and 1 center support

ITEM	PRICE
CRA4-SN	54
CRA4-ORB	
CRA8-SN	84
CRA8-ORB	

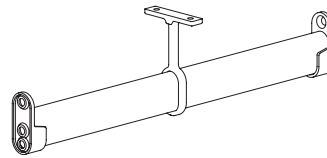

## JEWELRY TRAY

- Black Velvet Lined
- Available for 24", 30" and 36" wide cabinets.
- 21" deep cabinets.

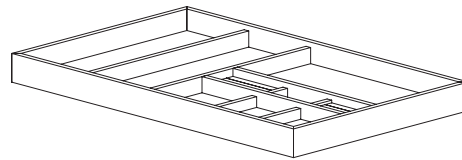

ITEM	PRICE
JT24	210
JT30	
JT36	

JT24

JT30

JT36

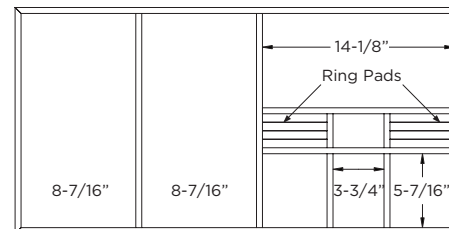
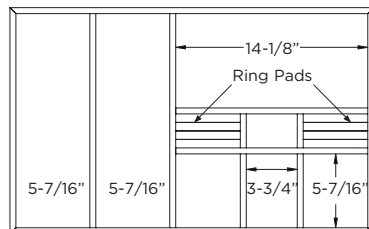
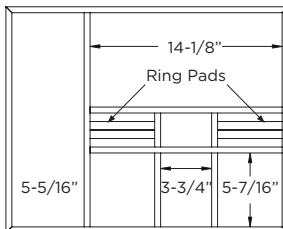

# ELAN CLOSET/FURNITURE CABINETS

## MUDROOM SPLIT WALL WITH DOORS

- 60" High x 15" Deep
- 12" Upper Cabinet Section
- Finished Interior, No Shelves

12"W - 24-1"W

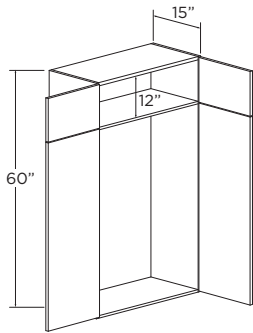

24-2"W - 42"W

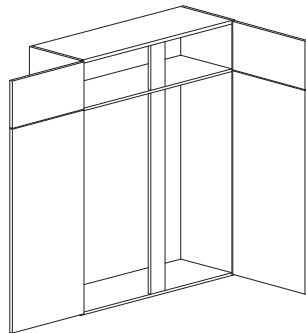

ITEM	A	B	C	D	E	F	G
EMRSW-D186015	1810	1900	1990	2081	2225	2316	2424
EMRSW-D216015	2009	2109	2209	2310	2470	2570	2691
EMRSW-D246015-1	2229	2340	2450	2563	2741	2852	2987
EMRSW-D246015-2	2403	2523	2643	2764	2956	3076	3220
EMRSW-D276015	2667	2800	2932	3067	3279	3413	3573
EMRSW-D306015	2578	2707	2835	2964	3170	3300	3454
EMRSW-D336015	2711	2848	2984	3118	3337	3474	3636
EMRSW-D366015	2851	2993	3136	3279	3507	3650	3821
EMRSW-D396015	2999	3149	3297	3449	3688	3839	4018
EMRSW-D426015	3155	3312	3469	3628	3879	4038	4227

**DESIGN NOTES:** Height modifications affect the upper section only unless otherwise specified.

## MUDROOM SPLIT WALL

- Finished Interior
- No Doors
- No shelves

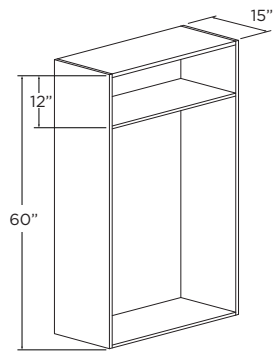

ITEM	PRICE
EMRSW186015	1340
EMRSW216015	1488
EMRSW246015	1651
EMRSW276015	1775
EMRSW306015	1910
EMRSW336015	2009
EMRSW366015	2112
EMRSW396015	2222
EMRSW426015	2338

**DESIGN NOTES:** Height modifications affect the upper section only unless otherwise specified.

## MUDROOM SPLIT WALL WITH NO BOTTOM FLOOR

- Finished Interior
- No Doors
- No shelves

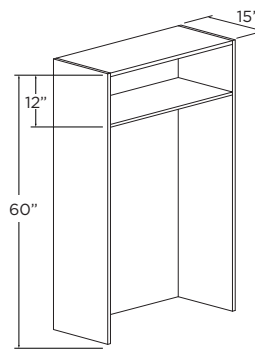

ITEM	PRICE
EMRSW-NBF186015	1340
EMRSW-NBF216015	1488
EMRSW-NBF246015	1651
EMRSW-NBF276015	1775
EMRSW-NBF306015	1910
EMRSW-NBF336015	2009
EMRSW-NBF366015	2112
EMRSW-NBF396015	2222
EMRSW-NBF426015	2338

**DESIGN NOTES:** Height modifications affect the upper section only unless otherwise specified.

## MUDROOM WALL

- 12" High x 15" Deep
- No Doors
- No Shelves
- Finished Interior
- Finished Flush Bottom

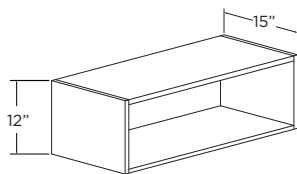

ITEM	PRICE
EMRW181215	751
EMRW211215	776
EMRW241215	802
EMRW271215	828
EMRW301215	854
EMRW331215	898
EMRW361215	943
EMRW391215	990
EMRW421215	1024

# ELAN CLOSET/FURNITURE CABINETS

## MUDROOM DRAWER

**1 DRAWER**  
18"W - 36"W

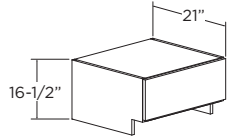

**2 DRAWER**  
39"W - 42"W

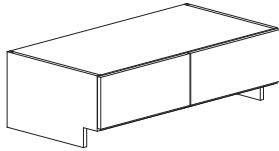

ITEM	A	B	C	D	E	F	G
EMRD18	747	781	794	808	842	954	1000
EMRD21	788	824	839	853	889	1009	1056
EMRD24	831	870	885	901	938	1064	1114
EMRD27	879	918	935	951	990	1125	1178
EMRD30	928	970	988	1005	1047	1188	1244
EMRD33	967	1010	1030	1047	1091	1237	1296
EMRD36	1007	1052	1072	1090	1137	1289	1350
EMRD39	1385	1447	1474	1499	1563	1772	1856
EMRD42	1443	1508	1536	1562	1629	1847	1934

## MUDROOM DRAWER WITH CUBBIES

**18", 21" & 24" DEEP**

- False Back at 15" Depth for Shoe Area
- Finished Interior
- No Toekick

**1 DRAWER**  
18"W - 36"W

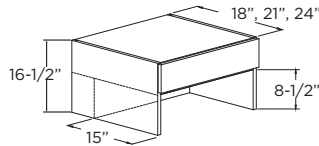

**2 DRAWER**  
39"W - 42"W

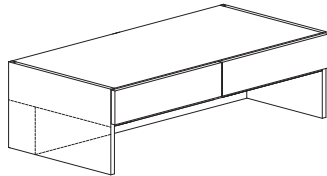

ITEM	A	B	C	D	E	F	G
EMRDC18	1032	1067	1080	1093	1128	1240	1286
EMRDC21	1073	1110	1125	1139	1174	1294	1342
EMRDC24	1117	1155	1170	1187	1224	1350	1400
EMRDC27	1165	1204	1221	1237	1276	1410	1464
EMRDC30	1213	1255	1273	1290	1332	1473	1530
EMRDC33	1252	1296	1315	1332	1377	1523	1582
EMRDC36	1292	1338	1358	1376	1423	1574	1635
EMRDC39	1670	1732	1760	1785	1849	2058	2142
EMRDC42	1729	1793	1822	1848	1914	2132	2220

## CABINERY USED TO CREATE THIS LOOK.

1. EMRSW186015, DEP Left
2. EMRSW186015
3. EMRSW186015
4. EMRSW186015, DEP Right
5. EMRDC36, DEP Left
6. EMRDC36, DEP Right
7. FBM-T96
8. CR1411
9. Wood Top/Veneer

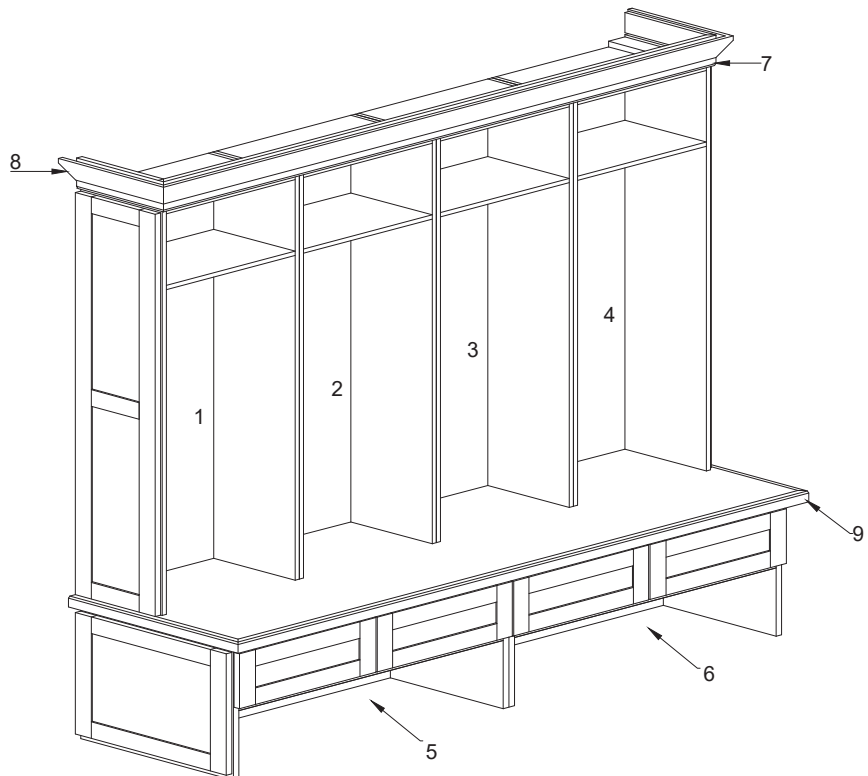





**TABLE OF CONTENTS**

**BATH CABINETS..... E1000-1 thru E1000-19**

Vanity Sink..... E1000-2  
Vanity Sink with Full Height Door(s)..... E1000-2  
Vanity Sink Front..... E1000-3  
Vanity 2 Drawers/3 Drawers/4 Drawers/6 Drawers..... E1000-3  
Vanity Base Cabinets..... E1000-4  
Vanity Base Full Height Door(s) Cabinets..... E1000-4  
Vanity 2 Drawer/3 Drawer/4 Drawer Bases..... E1000-5  
Vanity Pull-Out Storage..... E1000-6  
Vanity Outlet Drawer..... E1000-6  
Wall Mount Vanities..... E1000-7  
Wall Mount Linen Cabinet..... E1000-8  
Vanity Leg Base..... E1000-8  
Vanity Linen Cabinets..... E1000-9 thru E1000-10  
Vanity Wall Commode..... E1000-11  
Medicine Cabinet/Wall Cabinet/Mirrors..... E1000-11



# ELAN BATH CABINETS

## VANITY SINK

- Standard Height is 31", 34-1/2" available specify (T)
- Standard Depth is 21", 18" available, specify (18), at no charge.  
Example: EVS2118T or EVS2118

### SINGLE DOOR

- Specify Hinge (L or R)
- 21"W - 24-1"W

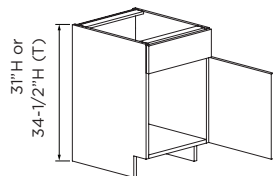

### BUTT DOORS

24-2"W - 36"W

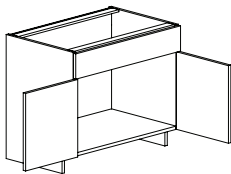

### DOUBLE DOORS

39"W - 48-2"W

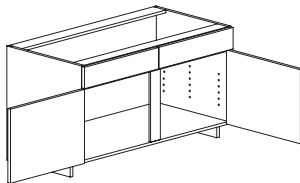

31" HIGH	A	B	C	D	E	F	G
No Shelves, No Drawers							
EVS21	636	667	698	731	782	814	852
EVS24-1	665	698	732	765	818	851	891
EVS24-2	732	770	806	844	902	938	982
EVS27	749	787	824	862	923	960	1004
EVS30	790	831	869	908	973	1011	1059
EVS33	818	861	901	941	1007	1046	1095
EVS36	862	906	949	991	1061	1103	1155
EVS39	890	935	979	1024	1095	1139	1193
EVS42	929	974	1021	1067	1143	1189	1245
EVS45	969	1020	1067	1116	1194	1241	1300
EVS48-2	1005	1056	1106	1156	1237	1286	1346

34-1/2" HIGH	A	B	C	D	E	F	G
No Shelves, No Drawers							
EVS21	699	735	770	804	861	896	938
EVS24-1	730	767	803	840	899	935	978
EVS24-2	806	846	886	927	991	1032	1081
EVS27	825	867	908	950	1016	1056	1106
EVS30	869	913	957	1000	1070	1114	1165
EVS33	901	946	991	1037	1109	1154	1208
EVS36	949	996	1044	1092	1167	1215	1271
EVS39	980	1029	1079	1128	1207	1256	1314
EVS42	1021	1072	1123	1175	1257	1307	1368
EVS45	1067	1121	1175	1227	1313	1367	1430
EVS48-2	1108	1163	1219	1274	1363	1418	1485

## VANITY SINK WITH FULL HEIGHT DOOR(S)

- Standard Height is 31", 34-1/2" available specify (T)
- Standard Depth is 21", 18" available, specify (18), at no charge.  
Example: EVS2718FHDT or EVS2718FHD
- 6" High Concealed Apron behind Door(s)

### SINGLE DOOR

- Specify Hinge (L or R)
- 24"W - 24-1"W

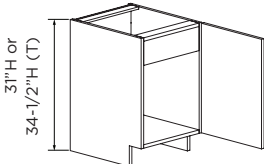

### BUTT DOORS

24-2"W - 36"W

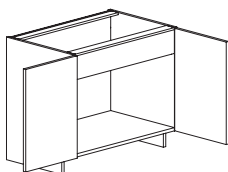

### DOUBLE DOORS

39"W - 48-2"W

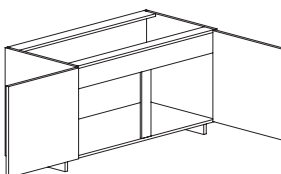

31" HIGH	A	B	C	D	E	F	G
No Shelves							
EVS24FHD-1	604	634	665	696	743	774	809
EVS24FHD-2	782	822	861	900	963	1002	1049
EVS27FHD	831	873	914	956	1023	1065	1115
EVS30FHD	885	929	974	1018	1089	1133	1187
EVS33FHD	933	979	1027	1073	1148	1194	1251
EVS36FHD	983	1032	1082	1131	1209	1259	1318
EVS39FHD	1042	1094	1147	1198	1281	1334	1396
EVS42FHD	1082	1136	1191	1245	1331	1385	1450
EVS45FHD	1127	1183	1241	1297	1388	1444	1511
EVS48FHD-2	1171	1230	1289	1347	1441	1500	1570

34-1/2" HIGH	A	B	C	D	E	F	G
No Shelves							
EVS24FHD-1T	664	697	731	764	817	851	890
EVS24FHD-2T	862	905	949	991	1061	1104	1155
EVS27FHDT	916	961	1007	1054	1127	1172	1227
EVS30FHDT	972	1021	1070	1119	1196	1245	1303
EVS33FHDT	1027	1078	1130	1181	1264	1315	1377
EVS36FHDT	1079	1133	1188	1242	1329	1383	1447
EVS39FHDT	1145	1203	1260	1318	1410	1467	1535
EVS42FHDT	1188	1248	1308	1367	1462	1522	1593
EVS45FHDT	1238	1301	1363	1424	1523	1586	1660
EVS48FHD-2T	1289	1353	1418	1483	1586	1650	1727

## VANITY SINK FRONT

- Includes Floor and Supports (Unassembled)
- 21" Depth Only

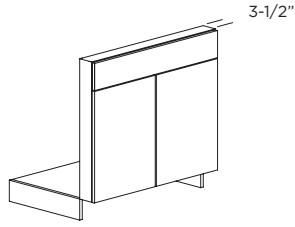

31" HIGH	A	B	C	D	E	F	G
EVSF24-2	545	572	600	627	671	698	731
EVSF27	572	600	630	659	704	734	768
EVSF30	594	623	654	683	731	762	797
EVSF33	620	650	682	714	763	793	831
EVSF36	641	672	705	737	789	820	859

34-1/2" HIGH	A	B	C	D	E	F	G
EVSF24-2T	598	627	658	688	736	765	802
EVSF27T	626	658	689	720	770	802	840
EVSF30T	653	686	719	752	803	836	875
EVSF33T	681	715	749	784	839	872	913
EVSF36T	705	741	776	812	868	903	946

## VANITY 2 DRAWERS

- Standard Height is 31", 34-1/2" available specify (T)
- Standard Depth is 21", 18" available, specify (18), at no charge.  
Example: EVSBD3018T or EVSBD3018
- Drawers Right Unless Specified Left

31" HIGH	A	B	C	D	E	F	G
No Shelves							
EVSBD24*	1377	1445	1515	1583	1693	1763	1845
EVSBD30	1447	1520	1593	1665	1781	1853	1940
EVSBD36	1539	1614	1693	1769	1892	1969	2061
EVSBD42	1619	1698	1781	1861	1990	2072	2168

34-1/2" HIGH	A	B	C	D	E	F	G
No Shelves							
EVSBD24T*	1383	1452	1522	1590	1702	1770	1853
EVSBD30T	1454	1526	1599	1672	1789	1861	1949
EVSBD36T	1543	1619	1698	1774	1897	1975	2067
EVSBD42T	1622	1701	1785	1865	1994	2076	2173

\* This drawer section is 9"

## SINGLE DOOR

24"W - 30"W

## BUTT DOORS

36"W - 42"W

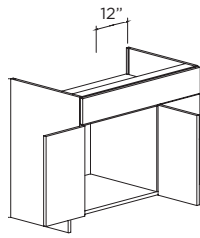
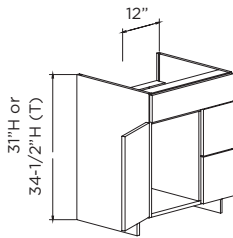

## VANITY 3 DRAWERS

- Standard Height is 31", 34-1/2" available specify (T)
- Standard Depth is 21", 18" available, specify (18), at no charge.  
Example: EV2418DRT or EV2418DR
- Drawer Stack on right (DR) is standard, specify for drawers left (DL).

31" HIGH	A	B	C	D	E	F	G
EV24DR*	1677	1745	1815	1883	1993	2063	2145
EV30DR	1747	1820	1893	1965	2081	2153	2240
EV36DR	1839	1914	1993	2069	2192	2269	2361
EV42DR	1919	1998	2081	2161	2290	2372	2468

## SINGLE DOOR

24"W - 30"W

## BUTT DOORS

36"W - 42"W

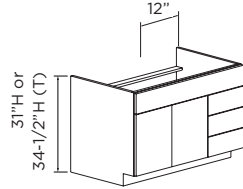
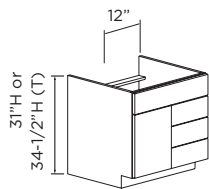

34-1/2" HIGH	A	B	C	D	E	F	G
EV24DRT*	1683	1752	1822	1890	2002	2070	2153
EV30DRT	1754	1826	1899	1972	2089	2161	2249
EV36DRT	1843	1919	1998	2074	2197	2275	2367
EV42DRT	1922	2001	2085	2165	2294	2376	2473

\* This drawer section is 9"

## VANITY 4 DRAWER

- Single door hinge right (HR) is standard, Hinge Left available, specify (HL).
- Standard Height is 31", 34-1/2" available specify (T)
- Standard Depth is 21", 18" available, specify (18), at no charge.  
Example: EVT4818T or EVT4818

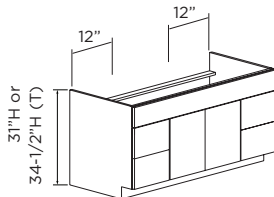

ITEM	A	B	C	D	E	F	G
EVSBD48	2754	2890	3030	3166	3926	3526	3690
EVSBD48T	2766	2904	3044	3180	3404	3540	3706

## VANITY 6 DRAWERS

- Standard Height is 31", 34-1/2" available specify (T)
- Standard Depth is 21", 18" available, specify (18), at no charge.  
Example: EV4818T or EV4818

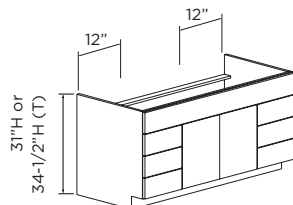

ITEM	A	B	C	D	E	F	G
EV6D48	3354	3490	3630	3766	3986	4126	4290
EV6D48T	3366	3504	3644	3780	4004	4140	4306

# ELAN BATH CABINETS

## VANITY BASE CABINETS

- Standard Height is 31", 34-1/2" available specify (T)
- Standard Depth is 21", 18" available, specify (18), at no charge.  
Example: EVB1218T or EVB1218

### SINGLE DOOR

- Specify Hinge (L or R)
- 12"W - 24-1"W

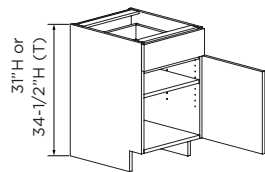

### BUTT DOORS

24-2"W - 36"W

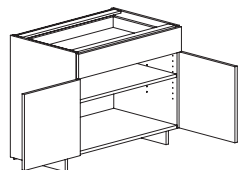

### DOUBLE DOORS

39"W - 48-2"W

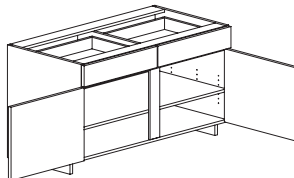

31" HIGH	A	B	C	D	E	F	G
1 Drawer, 1 Adjustable Shelf							
EVB12	671	704	738	773	826	859	900
EVB15	716	752	789	824	881	918	961
EVB18	764	802	841	879	940	978	1024
EVB21	807	847	888	928	993	1033	1082
EVB24-1	851	894	936	979	1048	1089	1141
EVB24-2	972	1021	1070	1119	1196	1245	1303
EVB27	1021	1072	1123	1175	1257	1307	1368
EVB30	1066	1120	1174	1226	1312	1366	1429
EVB33	1110	1165	1221	1278	1366	1422	1488
EVB36	1139	1197	1254	1311	1402	1458	1527
2 Drawers, 1 Adjustable Shelf							
EVB39	1170	1229	1287	1346	1440	1498	1568
EVB42	1199	1259	1320	1380	1476	1535	1608
EVB45	1229	1290	1352	1413	1512	1573	1647
EVB48-2	1258	1320	1384	1447	1548	1611	1686

34-1/2" HIGH	A	B	C	D	E	F	G
1 Drawer, 1 Adjustable Shelf							
EVB12T	735	771	809	846	905	941	985
EVB15T	787	826	867	906	969	1009	1055
EVB18T	831	873	914	956	1023	1065	1115
EVB21T	886	930	976	1020	1090	1134	1188
EVB24-1T	933	979	1027	1073	1148	1194	1251
EVB24-2T	1054	1106	1160	1213	1297	1350	1413
EVB27T	1109	1164	1220	1276	1364	1419	1487
EVB30T	1156	1214	1273	1330	1423	1480	1550
EVB33T	1207	1267	1328	1389	1485	1545	1617
EVB36T	1252	1314	1378	1440	1540	1603	1678
2 Drawers, 1 Adjustable Shelf							
EVB39T	1296	1361	1425	1490	1594	1659	1737
EVB42T	1341	1408	1476	1543	1650	1718	1797
EVB45T	1385	1455	1524	1593	1704	1774	1857
EVB48-2T	1430	1502	1573	1645	1760	1831	1917

## VANITY BASE FULL HEIGHT DOOR CABINETS

- Standard Height is 31", 34-1/2" available specify (T)
- Standard Depth is 21", 18" available, specify (18), at no charge.  
Example: EVB1218FHDT or EVB1218FHD

### SINGLE DOOR

- Specify Hinge (L or R)
- 12"W - 24-1"W

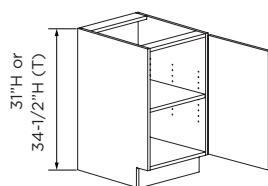

### BUTT DOORS

24-2"W - 36"W

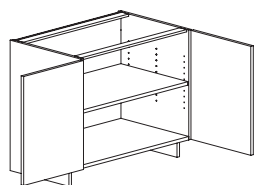

### DOUBLE DOORS

39"W - 48-2"W

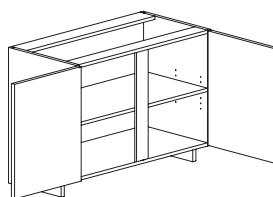

31" HIGH	A	B	C	D	E	F	G
1 Adjustable Shelf							
EVB12FHD	571	599	628	658	703	731	765
EVB15FHD	615	645	677	708	757	787	825
EVB18FHD	654	687	720	753	806	837	877
EVB21FHD	693	727	763	798	853	888	929
EVB24FHD-1	735	771	809	846	905	941	985
EVB24FHD-2	885	929	974	1018	1089	1133	1187
EVB27FHD	930	977	1024	1071	1145	1192	1247
EVB30FHD	971	1020	1068	1117	1194	1243	1301
EVB33FHD	1011	1061	1112	1164	1245	1295	1356
EVB36FHD	1049	1101	1154	1207	1291	1344	1406
EVB39FHD	1088	1142	1197	1252	1339	1394	1458
EVB42FHD	1126	1182	1240	1296	1385	1441	1510
EVB45FHD	1164	1223	1281	1339	1432	1490	1560
EVB48FHD-2	1167	1226	1285	1344	1436	1495	1565

34-1/2" HIGH	A	B	C	D	E	F	G
1 Adjustable Shelf							
EVB12FHDT	693	727	763	798	853	888	929
EVB15FHDT	752	790	828	866	925	963	1009
EVB18FHDT	804	845	885	925	990	1031	1078
EVB21FHDT	866	908	952	996	1065	1109	1160
EVB24FHDT-1T	917	963	1009	1055	1128	1174	1229
EVB24FHDT-2T	1064	1116	1170	1224	1309	1362	1425
EVB27FHDT	1123	1180	1236	1292	1383	1439	1506
EVB30FHDT	1182	1241	1301	1361	1455	1513	1584
EVB33FHDT	1237	1300	1362	1423	1522	1584	1659
EVB36FHDT	1291	1356	1421	1485	1588	1653	1731
EVB39FHDT	1345	1412	1479	1546	1654	1721	1802
EVB42FHDT	1399	1468	1539	1609	1721	1791	1874
EVB45FHDT	1452	1524	1598	1671	1787	1859	1946
EVB48FHDT-2T	1505	1581	1656	1731	1852	1927	2017

## VANITY 2 DRAWER BASE

- Standard Height is 31", 34-1/2" available specify (T)
- Standard Depth is 21", 18" available, specify (18), at no charge.  
Example: EV2DB1218T or EV2DB1218

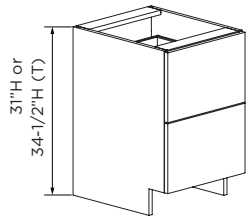

31" HIGH	A	B	C	D	E	F	G
EV2DB12	886	930	976	1020	1090	1134	1188
EV2DB15	950	998	1045	1093	1169	1216	1274
EV2DB18	1009	1059	1110	1160	1241	1291	1352
EV2DB21	1067	1121	1175	1227	1313	1367	1430
EV2DB24	1122	1178	1235	1291	1381	1438	1505
EV2DB27	1185	1243	1303	1363	1457	1517	1588
EV2DB30	1237	1300	1362	1423	1522	1584	1659
EV2DB33	1300	1364	1430	1495	1599	1664	1742
EV2DB36	1357	1425	1493	1561	1670	1737	1819

34-1/2" HIGH	A	B	C	D	E	F	G
EV2DB12T	991	1042	1092	1141	1220	1270	1329
EV2DB15T	1035	1087	1139	1192	1274	1326	1388
EV2DB18T	1099	1154	1209	1264	1352	1407	1473
EV2DB21T	1180	1238	1298	1357	1451	1511	1582
EV2DB24T	1230	1291	1353	1414	1513	1575	1649
EV2DB27T	1276	1340	1405	1468	1571	1634	1710
EV2DB30T	1326	1392	1460	1526	1632	1698	1778
EV2DB33T	1377	1445	1515	1583	1693	1763	1845
EV2DB36T	1427	1498	1570	1642	1756	1826	1912

## VANITY 3 DRAWER BASE

- Standard Height is 31", 34-1/2" available specify (T)
- Standard Depth is 21", 18" available, specify (18), at no charge.  
Example: EV3DB1218T or EV3DB1218

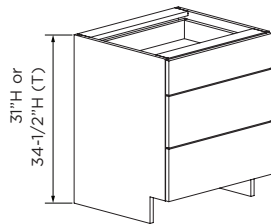

31" HIGH	A	B	C	D	E	F	G
EV3DB12	1046	1099	1152	1204	1287	1340	1403
EV3DB15	1112	1167	1224	1280	1369	1424	1491
EV3DB18	1174	1232	1291	1350	1444	1502	1573
EV3DB21	1238	1301	1363	1424	1523	1586	1660
EV3DB24	1307	1372	1438	1504	1608	1674	1752
EV3DB27	1372	1440	1510	1578	1688	1757	1839
EV3DB30	1436	1509	1581	1653	1768	1839	1925
EV3DB33	1502	1577	1653	1729	1848	1924	2013
EV3DB36	1567	1645	1725	1803	1928	2006	2100

34-1/2" HIGH	A	B	C	D	E	F	G
EV3DB12T	1130	1186	1243	1300	1390	1446	1515
EV3DB15T	1203	1263	1324	1384	1480	1540	1612
EV3DB18T	1270	1334	1397	1461	1562	1626	1703
EV3DB21T	1342	1410	1477	1544	1652	1719	1800
EV3DB24T	1414	1485	1556	1627	1741	1811	1896
EV3DB27T	1482	1556	1631	1704	1823	1897	1987
EV3DB30T	1548	1625	1703	1780	1905	1982	2075
EV3DB33T	1620	1700	1782	1863	1993	2073	2171
EV3DB36T	1689	1774	1859	1944	2078	2163	2264

## VANITY 4 DRAWER BASE

- Standard Height is 31", 34-1/2" available specify (T)
- Standard Depth is 21", 18" available, specify (18), at no charge.  
Example: EV4DB1218T or EV4DB1218

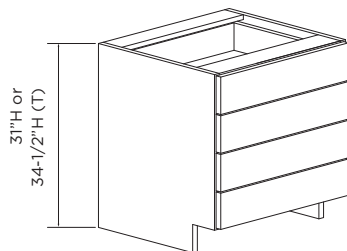

31" HIGH	A	B	C	D	E	F	G
EV4DB12	1346	1399	1452	1504	1587	1640	1703
EV4DB15	1412	1467	1524	1580	1669	1724	1791
EV4DB18	1474	1532	1591	1650	1744	1802	1873
EV4DB21	1538	1601	1663	1724	1823	1886	1960
EV4DB24	1607	1672	1738	1804	1908	1974	2052
EV4DB27	1672	1740	1810	1878	1988	2057	2139
EV4DB30	1736	1809	1881	1953	2068	2139	2225
EV4DB33	1802	1877	1953	2029	2148	2224	2313
EV4DB36	1867	1945	2025	2103	2228	2306	2400

34-1/2" HIGH	A	B	C	D	E	F	G
EV4DB12T	1430	1486	1543	1600	1690	1746	1815
EV4DB15T	1503	1563	1624	1684	1780	1840	1912
EV4DB18T	1570	1634	1697	1761	1862	1926	2003
EV4DB21T	1642	1710	1777	1844	1952	2019	2100
EV4DB24T	1714	1785	1856	1927	2041	2111	2196
EV4DB27T	1782	1856	1931	2004	2123	2197	2287
EV4DB30T	1848	1925	2003	2080	2205	2282	2375
EV4DB33T	1920	2000	2082	2163	2293	2373	2471
EV4DB36T	1989	2074	2159	2244	2378	2463	2564

# ELAN BATH CABINETS

## VANITY PULL-OUT STORAGE

### Style A

- Stainless Steel Storage Bins

### Style B

- Polycarbonate Bins

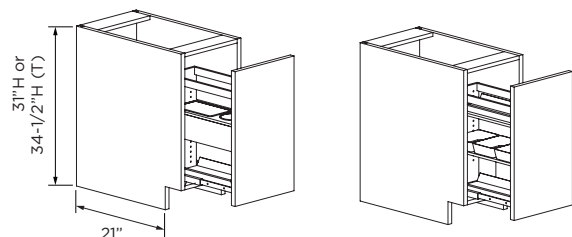

STYLE A	A	B	C	D	E	F	G
2 Stainless Steel Adjustable Storage Bins, 1 Adjustable Shelf							
EVPOS12A	1155	1213	1271	1329	1422	1479	1549
EVPOS12AT	1274	1337	1402	1466	1567	1631	1708

STYLE B	A	B	C	D	E	F	G
6 Polycarbonate Bins, 3 Adjustable Shelves							
EVPOS12B	1258	1320	1384	1447	1548	1611	1686
EVPOS12BT	1400	1469	1540	1610	1723	1792	1877

## VANITY HAMPER PULL-OUT

- 18" Width Only
- Specify Hinge (L or R)
- Decrease Depth Not Available
- White wire hamper

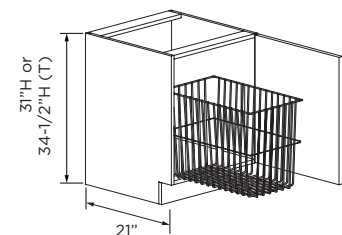

ITEM	A	B	C	D	E	F	G
EVHPO18	836	878	921	962	1029	1071	1121
EVHPO18T	870	914	958	1001	1071	1115	1167

## VANITY PULL-OUT WASTE CAN

- Specify Hinge (L or R)

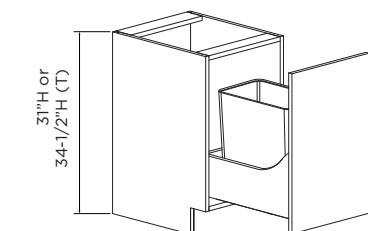

31" HIGH	A	B	C	D	E	F	G
1 - 35 QT. Wastebasket							
EVPOW15FHD	1039	1064	1089	1113	1154	1190	1224
EVPOW18FHD	1085	1111	1138	1163	1205	1247	1281
EVPOW21FHD	1131	1159	1187	1213	1256	1304	1340

34-1/2" HIGH	A	B	C	D	E	F	G
1 - 35 QT. Wastebasket							
EVPOW15FHDT	1142	1169	1197	1224	1268	1308	1344
EVPOW18FHDT	1192	1221	1251	1278	1325	1371	1409
EVPOW21FHDT	1242	1273	1305	1333	1381	1433	1472

## VANITY PULL-OUT ORGANIZER

- Mounts to Cabinet Floor
- L Shape for Plumbing
- 6 Polycarbonate Bins
- Full Extension Soft Motion Glides
- Left or Right Installation
- 21" Deep

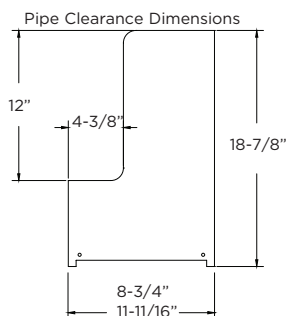
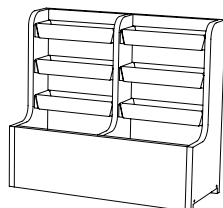

ITEM	PRICE
VPOSC12	599
VPOSC15	721

## VANITY OUTLET DRAWER

- Fits in a 18" Wide Cabinet, middle drawer
- 2 stainless steel cups for safe storage of curling irons, heat iron, blow dryer, etc.
- (2) 120V Plugs
- Power Cord with Nema 5-15 Plug

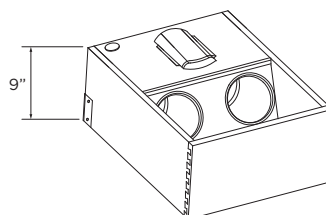

ITEM	PRICE
EVOD18	1125

# ELAN BATH CABINETS

## WALL MOUNT VANITY SINK

- 18" Depth Available, Specify

### BUTT DOOR

24"W - 36"W

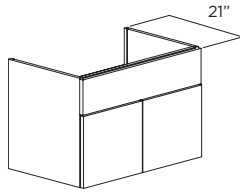

### FULL HEIGHT BUTT DOOR

24"W - 36"W

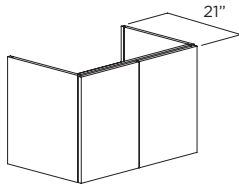

19-7/8" HIGH	A	B	C	D	E	F	G
EVSWM24	834	876	918	960	1027	1068	1118
EVSWM27	877	921	964	1008	1078	1123	1175
EVSWM30	928	974	1021	1068	1142	1189	1244
EVSWM33	1000	1050	1100	1151	1231	1281	1341
EVSWM36	1094	1149	1203	1259	1346	1402	1467

19-7/8" HIGH	A	B	C	D	E	F	G
EVSWM24FHD	834	876	918	960	1027	1068	1118
EVSWM27FHD	877	921	964	1008	1078	1123	1175
EVSWM30FHD	928	974	1021	1068	1142	1189	1244
EVSWM33FHD	1000	1050	1100	1151	1231	1281	1341
EVSWM36FHD	1094	1149	1203	1259	1346	1402	1467

## WALL MOUNT FULL HEIGHT DOOR

- 12", 15" and 18" Depth Available, Specify

### SINGLE DOOR

- Specify Hinge (L or R)
- 12"W - 18"W

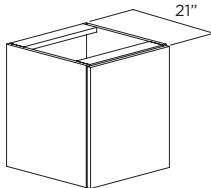

### BUTT DOORS

24"W

19-7/8" HIGH	A	B	C	D	E	F	G
EVWM12FHD	671	704	738	772	826	859	899
EVWM15FHD	708	743	778	814	870	906	948
EVWM18FHD	745	782	819	857	916	954	999
EVWM24FHD	818	859	900	941	1006	1047	1096

## WALL MOUNT DRAWERS

- 18" Depth Available, Specify

### TWO DRAWER

12"W - 24"W

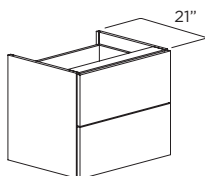

### THREE DRAWER

12"W - 24"W

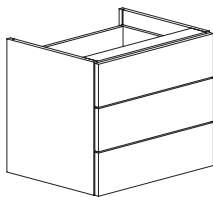

2 DRAWER	A	B	C	D	E	F	G
EV2DWM12	1189	1248	1308	1368	1464	1523	1594
EV2DWM15	1231	1293	1354	1416	1514	1576	1650
EV2DWM18	1296	1361	1427	1492	1595	1661	1738
EV2DWM24	1352	1420	1488	1556	1664	1732	1813

3 DRAWER	A	B	C	D	E	F	G
EV3DWM12	1382	1451	1521	1590	1702	1770	1853
EV3DWM15	1434	1506	1577	1649	1763	1836	1921
EV3DWM18	1490	1565	1640	1715	1834	1909	1998
EV3DWM24	1547	1624	1702	1780	1904	1982	2074

## WALL MOUNT OPEN SHELF

- 12", 15", and 18" Depth Available, Specify
- Interiors of Open Shelf Units will Match Exterior

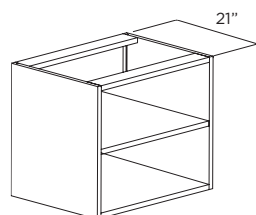

ITEM	A	B	C	D	E	F	G
1 Adjustable Shelf							
EVOSWM12	801	841	882	922	987	1026	1074
EVOSWM15	835	876	918	960	1026	1068	1118
EVOSWM18	865	908	951	995	1064	1108	1159
EVOSWM24	932	978	1025	1072	1147	1194	1249

# ELAN BATH CABINETS

## WALL MOUNT LINEN CABINET

- 3 Adjustable Shelves
- Specify Hinge (L or R)

### SINGLE DOOR

- Specify Hinge (L or R)
- 12"W - 18"W

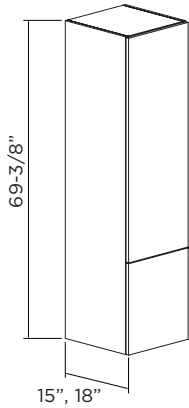

### BUTT DOORS

24"W

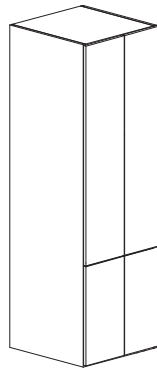

69-3/8" HIGH	A	B	C	D	E	F	G
<b>15" DEEP</b>							
ELCWM1215HR	1677	1761	1846	1930	2066	2149	2249
ELCWM1515HR	1931	2027	2123	2220	2374	2471	2587
ELCWM1815HR	2044	2146	2249	2352	2515	2618	2741
ELCWM2415	2240	2352	2465	2578	2756	2869	3003
<b>18" DEEP</b>							
ELCWM1218HR	1851	1944	2037	2130	2280	2371	2482
ELCWM1518HR	2046	2148	2249	2352	2516	2619	2741
ELCWM1818HR	2262	2375	2489	2603	2783	2897	3033
ELCWM2418	2475	2599	2723	2848	3046	3170	3319

## VANITY LEG BASE

- Available in 18" and 21" Depth
- Standard Height is 11", Also Available 14-1/2" Height, Specify (T)

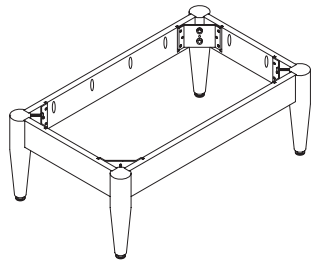

11" HIGH	PRICE
VLBA30	495
VLBA36	500
VLBA48	507

14-1/2" HIGH	PRICE
VLBA30T	570
VLBA36T	574
VLBA48T	583

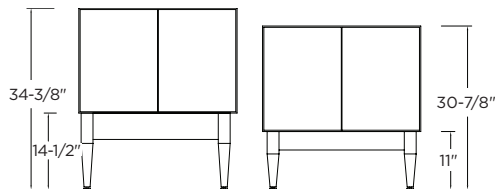



## VANITY LINEN CABINET 84", 90" & 96" HIGH

- 21" Depth is Standard.
- Available 18" or 12" depth for no charge.
- Specify 18" or 12" after the code. Example EVLC158412
- Cabinets over 96" High Not Available in Foil

### SINGLE DOOR

- Specify Hinge (L or R)
- 15"W - 24-1"W

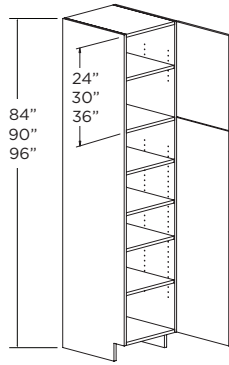

### BUTT DOORS

24-2"W - 36"W

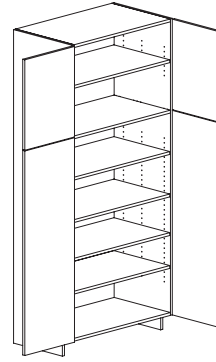

84" HIGH	A	B	C	D	E	F	G
24" Top Section Height, 4 Adjustable Shelves							
EVLC1584	1713	1798	1885	1971	2108	2193	2296
EVLC1884	1836	1928	2021	2112	2259	2351	2461
EVLC2184	1950	2048	2145	2243	2399	2496	2614
EVLC2484-1	2032	2133	2236	2337	2500	2601	2724
EVLC2484-2	2158	2265	2374	2482	2654	2763	2892
EVLC2784	2381	2500	2620	2740	2930	3049	3192
EVLC3084	2506	2632	2757	2883	3083	3208	3358
EVLC3384	2652	2784	2917	3050	3262	3395	3554
EVLC3684	2796	2935	3076	3216	3440	3579	3747

90" HIGH	A	B	C	D	E	F	G
30" Top Section Height, 4 Adjustable Shelves							
EVLC1590	1874	1967	2062	2156	2306	2400	2512
EVLC1890	2009	2109	2212	2311	2472	2573	2693
EVLC2190	2133	2242	2347	2455	2625	2731	2861
EVLC2490-1	2223	2334	2446	2558	2735	2847	2980
EVLC2490-2	2360	2478	2597	2716	2905	3024	3165
EVLC2790	2606	2736	2868	2999	3207	3335	3494
EVLC3090	2741	2881	3017	3155	3374	3509	3674
EVLC3390	2903	3045	3192	3338	3569	3715	3889
EVLC3690	3060	3213	3367	3518	3766	3917	4100

96" HIGH	A	B	C	D	E	F	G
36" Top Section Height, 5 Adjustable Shelves							
EVLC1596	2052	2154	2258	2361	2525	2628	2751
EVLC1896	2199	2309	2423	2531	2707	2817	2949
EVLC2196	2336	2455	2570	2688	2875	2990	3132
EVLC2496-1	2434	2555	2678	2801	2995	3118	3263
EVLC2496-2	2585	2714	2844	2974	3181	3311	3466
EVLC2796	2853	2996	3140	3284	3512	3652	3826
EVLC3096	3002	3155	3303	3455	3694	3843	4023
EVLC3396	3179	3335	3495	3655	3908	4068	4259
EVLC3696	3351	3518	3687	3852	4123	4289	4489

## VANITY LINEN CABINET WITH HAMPER 84", 90" & 96" HIGH

- 18" Width Only
- Specify Hinge (L or R)
- Decrease Depth Not Available
- Cabinets over 96" High Not Available in Foil
- White wire hamper

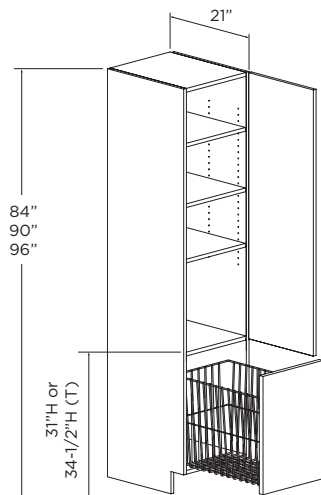

84" HIGH	A	B	C	D	E	F	G
2 Adjustable Shelves							
EVLC1884	2130	2236	2344	2450	2620	2726	2855
EVLC1884T	2130	2236	2344	2450	2620	2726	2855

90" HIGH	A	B	C	D	E	F	G
2 Adjustable Shelves							
EVLC1890	2259	2372	2489	2600	2780	2892	3030
EVLC1890T	2259	2372	2489	2600	2780	2892	3030

96" HIGH	A	B	C	D	E	F	G
3 Adjustable Shelves							
EVLC1896	2388	2508	2630	2748	2939	3057	3202
EVLC1896T	2388	2508	2630	2748	2939	3057	3202

# ELAN BATH CABINETS

## VANITY LINEN CABINET WITH DRAWERS 84", 90" & 96" HIGH

- 21" Depth is Standard.
- Available 18" or 12" depth for no charge.
- Specify 18" or 12" after the code. Example EVLCD158418
- Cabinets over 96" High Not Available in Foil

### SINGLE DOOR

- Specify Hinge (L or R)
- 15"W - 24-1"W

### BUTT DOORS

- 24-2"W - 36"W

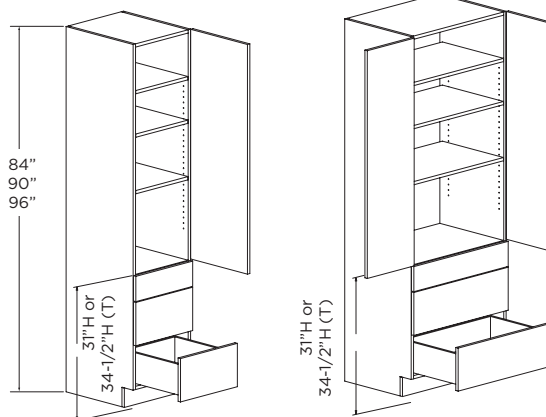

84" HIGH	A	B	C	D	E	F	G
31" High Lower Section, 3 Adjustable Shelves							
EVLCD1584	2455	2577	2701	2824	3020	3143	3290
EVLCD1884	2606	2737	2868	2998	3207	3336	3493
EVLCD2184	2731	2868	3005	3142	3359	3496	3660
EVLCD2484-1	2839	2980	3123	3265	3493	3634	3804
EVLCD2484-2	2958	3106	3254	3402	3639	3787	3965
EVLCD2784	3202	3362	3522	3682	3939	4099	4291
EVLCD3084	3379	3548	3718	3886	4157	4325	4528
EVLCD3384	3548	3725	3903	4081	4364	4542	4754
EVLCD3684	3696	3880	4066	4251	4546	4731	4952

90" HIGH	A	B	C	D	E	F	G
31" High Lower Section, 4 Adjustable Shelves							
EVLCD1590	2567	2693	2822	2951	3156	3285	3439
EVLCD1890	2724	2860	2997	3134	3352	3486	3652
EVLCD2190	2854	2997	3141	3285	3510	3654	3824
EVLCD2490-1	2969	3114	3264	3413	3650	3799	3977
EVLCD2490-2	3093	3248	3401	3557	3803	3959	4144
EVLCD2790	3347	3514	3683	3848	4119	4284	4484
EVLCD3090	3531	3708	3886	4064	4345	4520	4735
EVLCD3390	3708	3893	4080	4267	4563	4749	4967
EVLCD3690	3863	4057	4251	4442	4750	4945	5176

84" HIGH	A	B	C	D	E	F	G
34-1/2" High Lower Section, 3 Adjustable Shelves							
EVLCD1584T	2455	2577	2701	2824	3020	3143	3290
EVLCD1884T	2606	2737	2868	2998	3207	3336	3493
EVLCD2184T	2731	2868	3005	3142	3359	3496	3660
EVLCD2484-1T	2839	2980	3123	3265	3493	3634	3804
EVLCD2484-2T	2958	3106	3254	3402	3639	3787	3965
EVLCD2784T	3202	3362	3522	3682	3939	4099	4291
EVLCD3084T	3379	3548	3718	3886	4157	4325	4528
EVLCD3384T	3548	3725	3903	4081	4364	4542	4754
EVLCD3684T	3696	3880	4066	4251	4546	4731	4952

90" HIGH	A	B	C	D	E	F	G
34-1/2" High Lower Section, 4 Adjustable Shelves							
EVLCD1590T	2567	2693	2822	2951	3156	3285	3439
EVLCD1890T	2724	2860	2997	3134	3352	3486	3652
EVLCD2190T	2854	2997	3141	3285	3510	3654	3824
EVLCD2490-1T	2969	3114	3264	3413	3650	3799	3977
EVLCD2490-2T	3093	3248	3401	3557	3803	3959	4144
EVLCD2790T	3347	3514	3683	3848	4119	4284	4484
EVLCD3090T	3531	3708	3886	4064	4345	4520	4735
EVLCD3390T	3708	3893	4080	4267	4563	4749	4967
EVLCD360T	3863	4057	4251	4442	4750	4945	5176

96" HIGH	A	B	C	D	E	F	G
31" High Lower Section, 4 Adjustable Shelves							
EVLCD1596	2678	2809	2944	3078	3292	3427	3587
EVLCD1896	2841	2983	3126	3269	3496	3636	3809
EVLCD2196	2977	3126	3276	3426	3661	3811	3989
EVLCD2496-1	3096	3248	3404	3560	3807	3963	4148
EVLCD2496-2	3226	3388	3547	3709	3967	4130	4323
EVLCD2796	3491	3665	3841	4014	4296	4468	4677
EVLCD3096	3683	3867	4053	4238	4532	4714	4938
EVLCD3396	3867	4060	4255	4450	4759	4954	5181
EVLCD3696	4029	4231	4434	4633	4954	5158	5399

96" HIGH	A	B	C	D	E	F	G
34-1/2" High Lower Section, 4 Adjustable Shelves							
EVLCD1596T	2678	2809	2944	3078	3292	3427	3587
EVLCD1896T	2841	2983	3126	3269	3496	3636	3809
EVLCD2196T	2977	3126	3276	3426	3661	3811	3989
EVLCD2496-1T	3096	3248	3404	3560	3807	3963	4148
EVLCD2496-2T	3226	3388	3547	3709	3967	4130	4323
EVLCD2796T	3491	3665	3841	4014	4296	4468	4677
EVLCD3096T	3683	3867	4053	4238	4532	4714	4938
EVLCD3396T	3867	4060	4255	4450	4759	4954	5181
EVLCD3696T	4029	4231	4434	4633	4954	5158	5399

# ELAN BATH CABINETS

## VANITY WALL COMMODE

- 9" Deep
- Finished Interior
- 1 Adjustable Shelf

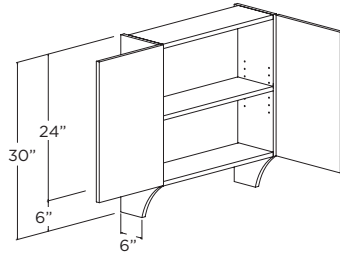

ITEM	A	B	C	D	E	F	G
EVWC2430-2	1015	1065	1116	1167	1248	1300	1361
EVWC2730	1059	1111	1165	1218	1303	1356	1419

## WALL COMMODE

- Opening: 22-1/2"W x 8-7/8"H
- 9" Depth
- 1 Adjustable Shelf
- Finished Interior

ITEM	PRICE
EWCC2430	958

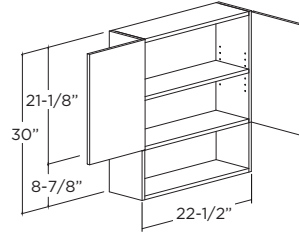

## MEDICINE CABINET

- Surface Mount
- Specify Hinge (L or R)
- 2 Shelves

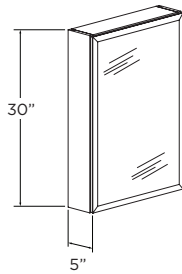

ITEM	PRICE
EMC1830	598
EMC2130	650
EMC2430	705

## VANITY WALL CABINETS

- 2 Adjustable Shelves
- Specify Hinge (L or R)

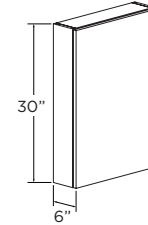

ITEM	A	B	C	D	E	F	G
EVW930	425	446	468	490	524	545	571
EVW1230	460	483	506	529	566	589	616
EVW1530	493	517	543	567	606	631	661
EVW1830	528	555	582	608	650	676	708
EVW2130	564	592	621	649	694	722	756
EVW2430-1	599	628	659	689	737	768	803
EVW2430-2	638	670	703	735	786	819	856

## TRI-VIEW MEDICINE CABINET

- Surface Mount

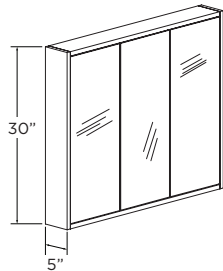

ITEM	SHELVES	PRICE
ETV2430	3	617
ETV3030	9	693
ETV3630	9	767
ETV4830	9	891

## FRAMED MIRROR

- Beveled Mirror
- Available in Square Framed Door Styles Only.

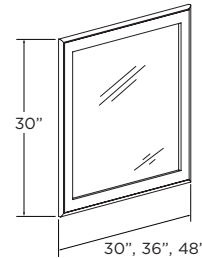

ITEM	PRICE
EFM3030	381
EFM3630	425
EFM4830	526

## OVAL MIRROR

- Beveled Mirror

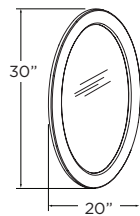

ITEM	PRICE
EFOM	436

## OVAL MEDICINE CABINET

- 4-1/4" Deep
- Box Size: 13-7/16"W x 15-7/8"H x 3-1/2"D
- 2 Adjustable Shelves
- Specify Hinge (L or R)
- Beveled Mirror
- Frame Profile Will Match the Door Profile

ITEM	PRICE
EOMC	786

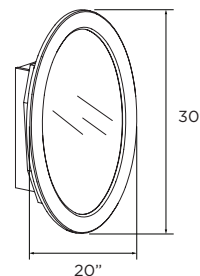





**TABLE OF CONTENTS**

**MODIFICATIONS ..... E1100-1 thru E1100-7**

Increase/Decrease Dimension .....	E1100-2
Finished Side .....	E1100-3
Grooved Flush Finished Side .....	E1100-3
Side Extended Back.....	E1100-3
Extended Side Up or Down.....	E1100-3
Back Extended Down.....	E1100-3
Two Finishes/One Cabinet.....	E1100-3
Finished Interior .....	E1100-3
Decorative End Panel.....	E1100-3
Flush Finished Top or Bottom.....	E1100-4
Finished Back .....	E1100-4
Tru-Bead Back .....	E1100-4
Grooved Interior Back .....	E1100-4
Mirror Lined Back .....	E1100-4
Recessed Bottom .....	E1100-4
Applied Valance Rail Top.....	E1100-4
Box Only.....	E1100-5
Cabinet - No Doors .....	E1100-5
Flush Toe Space/ Recessed Toekick/Toe Space Drawer .....	E1100-5
Omit Bottom Floor.....	E1100-5
Ship Subtoe Loose .....	E1100-5
Fixed Vertical Divider .....	E1100-5
Retractable Doors .....	E1100-6
Pipe Chase.....	E1100-6
Peninsula Cabinet .....	E1100-6
Convert Shelf.....	E1100-6
Walnut Drawer Box.....	E1100-6
Plate Groove.....	E1100-7
Split Drawer .....	E1100-7
Custom Front Arrangement.....	E1100-7



# ELAN MODIFICATIONS

## DECREASE DIMENSIONS

- Most cabinets can be decreased in height, width or depth for no charge.
- Specify the next larger cabinet size and specify the dimension(s) to be decreased.
- See door style section for individual door/drawer front sizing.

Example: EB36  
DW Width: 35"

Minimum cabinet width: 9"

Minimum cabinet depth (with drawer): 12"  
Minimum cabinet depth (without drawer): 4-1/2"  
Cabinets with decreased depth are supplied with standard depth drawers & guides only.  
(21", 18", 15", 12", 9" deep drawer box.)

Minimum height of wall cabinet: 12"  
Minimum height of base cabinet without a drawer: 16-1/2"  
Minimum height of 1-drawer base: 10-5/8"  
Minimum height of 2-drawer base: 15-1/8"  
Minimum height of 3-drawer base: 19-3/4"  
Minimum height of 4-drawer base: 24-1/4"

ITEM	PRICE
Decrease Width (DW)	N/C
Decrease Depth (DD)	N/C
Decrease Height (DH)	N/C

## INCREASE DIMENSIONS

- Most cabinets can be increased in height, width or depth.
- Specify the largest cabinet size and specify the dimension(s) to be increased.

Example: EBR159612  
IDIM, Height = 102"

Maximum width of tall cabinet: 36"  
Maximum width of base or wall cabinet: 48"  
Maximum width of vanity console cabinet: 72"

Maximum depth of wall or tall cabinet: 30" (walls over 15" deep should be anchored through one or both sides)  
Maximum depth of base cabinet: 36" (Drawers remain standard 24" depth unless quoted.)

Maximum height of tall cabinet: 120"  
Maximum height of base cabinet: 48"  
Maximum height of wall cabinet: 72"

ITEM	PRICE
Increase Dimensions (IDIM)	35%

*35% total up-charge for 1, 2 or 3 increased dimensions*

## INCREASE DEPTH TO 13" 12" DEEP CABINETS ONLY:

- INCD13 modification is designed to increase a standard 12" deep cabinet to 13".
- Modification needs to be applied to every cabinet affected.
- 12" x 12" angle and corner cabinets would become 13" x 13".
- Diagonal cabinets remain 24" wide but with a 13" depth.

ITEM	PRICE
Increase Depth 13" (INCD13)	5%

## INCREASE DEPTH TO 15" 12" DEEP CABINETS ONLY:

- INCD15 modification is designed to increase a standard 12" deep cabinet to 15".
- Modification needs to be applied to every cabinet affected.
- 12" x 12" angle and corner cabinets would become 15" x 15".
- Diagonal cabinets remain 24" wide but with a 15" depth.

ITEM	PRICE
Increase Depth 15" (INCD15)	10%

## FINISHED SIDE

- Exposed cabinet side in a matching veneer and finish on the exterior.
- Exposed finished ends are N/C. If a concealed cabinet side is to be finished, an upcharge applies.
- Specify Side (L or R)

	ITEM	PRICE
Walls	Exposed	N/C
	Concealed	29
Bases	Exposed	N/C
	Concealed	40
Talls	Exposed	N/C
	Concealed	70

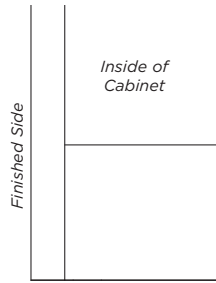

## GROOVED FLUSH FINISHED SIDE

- Specify Side (L or R)

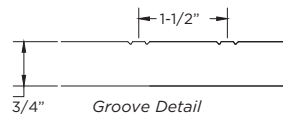

	PRICE
Walls	34/SQ.FT. + 56/Side
Bases	34/SQ.FT. + 93/Side
Talls	34/SQ.FT. + 149/Side

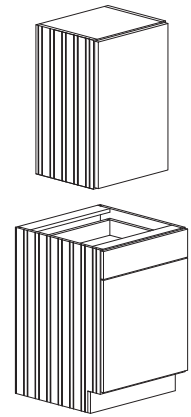

## DECORATIVE END PANEL (APPLIED DOOR ON END)

- Minimum Cabinet Depth is 9"
- Decorative panel (door) is applied to a Finished Side. matches the door style, 3/4" thick, with reveals to match the front.
- Specify side (L or R)

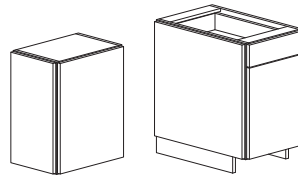

	ITEM	PRICE
Walls	12" - 27"H	192
	30" - 48"H	232
	52-1/2" - 66"H	312
Bases	DEP(L-R)	351
Talls	DEP(L-R) 12"D	497
	DEP(L-R) 24"D	645

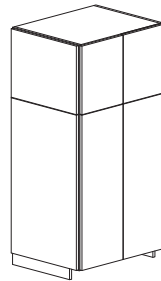

## SIDE EXTENDED BACK

- Specify Side (L or R)
- Specify Overall Depth
- Specify finished side, if needed.
- If extended side is to be edgebanded, specify, and add 16/lineal foot.

	ITEM	PRICE
Walls	WSEB	159
Bases	EBSEB	
Talls	ETSEB	317

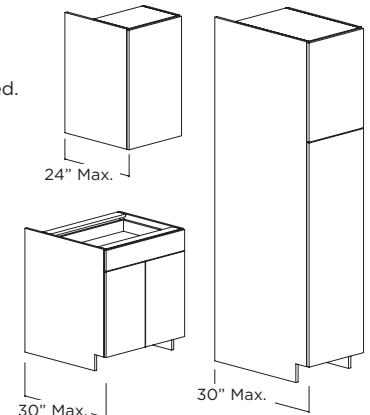

## EXTENDED SIDE UP OR DOWN

- Specify Extended Side (L or R)
- Specify Extension Length (Max. 18")
- Specify finished interior and/or finished side, if needed.

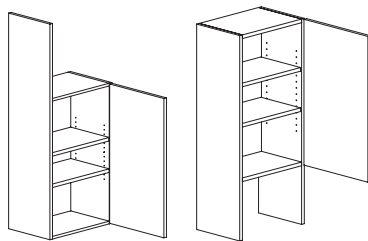

ITEM	PRICE
ESU	253
ESD	

## BACK EXTENDED DOWN

- Available Only When Both Sides Are Extended Down
- Back Extension Will Be Flush With Side Extensions
- Specify Finished Interior, if Needed.

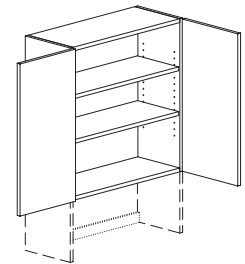

	ITEM	PRICE
Walls	BED	159

## TWO FINISHES/ONE CABINET .....40%

- Must specify in special instructions on the order form.

### CASE/DOORS & DRAWER FRONTS

- Select one species/finish for the doors and drawer fronts.
- Select a second species/finish for the cabinet box.
- If finished sides are needed, specify.

### EXTERIOR/INTERIOR

- Select one species/finish for the cabinet face, doors and drawer fronts.
- Select a second species/finish for the cabinet interior (interior sides, floor, ceiling, back and shelves.)
- Drawer Boxes and accessories (i.e. cutlery tray, spice tray, pull-outs, etc.) will be Birch with a natural finish only.
- If finished sides are needed, specify.

## FINISHED INTERIOR

- Cabinet Interior is finished in the wood species or material and finish chosen for job.

	ITEM	PRICE
Walls, Bases, Talls	FI	25%

# ELAN MODIFICATIONS

## FLUSH FINISHED TOP/BOTTOM

- Specify Finished Top or Finished Bottom (Walls)
- Specify Flush Finished Top (Bases, Talls)
- Will match the finish of the door

	ITEM	PRICE
Walls	FT/FB	209
Bases, Talls	FT	409

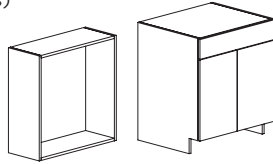

## TRU-BEAD BACK

- Moulded Solid Wood Pieces Attached Together and Applied to a 1/4" Panel
- Decreased Interior Depth by 5/16"
- Specify TBB-3 or TBB-6

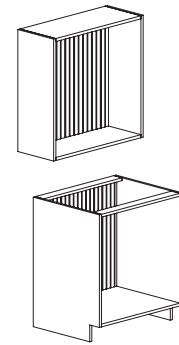
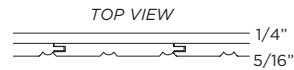

	ITEM	PRICE
Walls, Bases, Talls	TBB-3 TBB-6	68/SQ.FT.

## FINISHED BACK

- Attached to back of cabinet box, adds 3/4" to the depth of the cabinet. Banded all edges.
- Applied to Single Cabinets Only
- Back Extends to Bottom of Cabinet

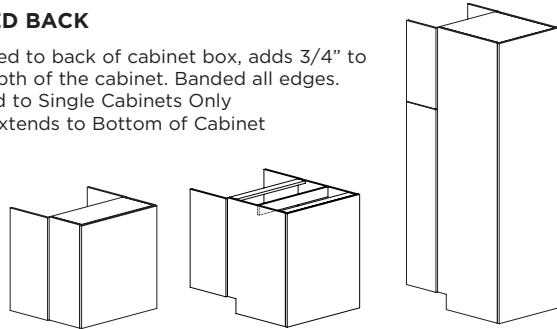

	ITEM	PRICE
Walls, Bases, Talls	FB	38/SQ. FT.

## MIRROR LINED BACK

- Mirror Attaches to Cabinet Back
- Mirror Shipped Loose

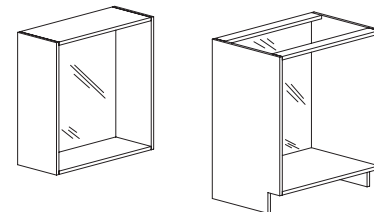

	ITEM	PRICE
Walls, Bases	MLB	55/SQ.FT.

## GROOVED INTERIOR BACK

- 1/4" Plywood with Scored V-Grooves

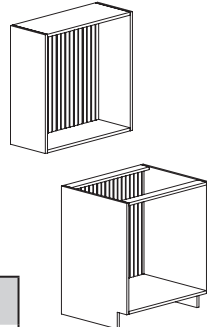
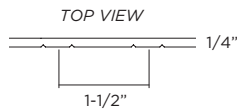

	ITEM	PRICE
Walls, Bases, Talls	GIB	34/SQ.FT.

## APPLIED VALANCE TOP RAIL

- All Doors Removed and Interior Finished
- Specify Valance Style Below

ITEM	PRICE
Straight	125
Arched, Mission, Traditional	220

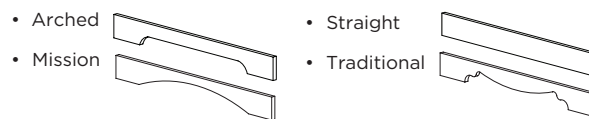

## RECESSED BOTTOM

- Bottom is recessed 3/4". Cabinet back is recessed too. Doors remain full height and extend below the cabinet.
- Sides can be recessed or not, specify L, R, Both (B) or None (N).
- Recessed Bottom Light Rail (RBLR) can be ordered separately in 8' lengths for seamless installation. RBLR is 3/4" x 3" edgebanded and finished.
- Specify Finished Sides and/or Finished Interior if needed.

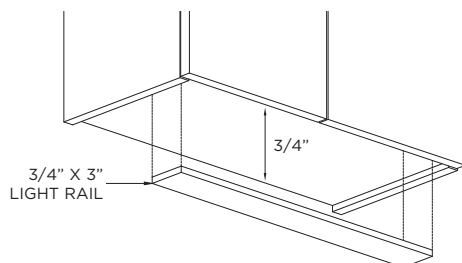

ITEM	PRICE
RB - L (Left side recessed)	260
RB - R (Right side recessed)	
RB - B (Both sides recessed)	
RB - N (Sides not recessed)	
RBLR 8' lengths	148 Each

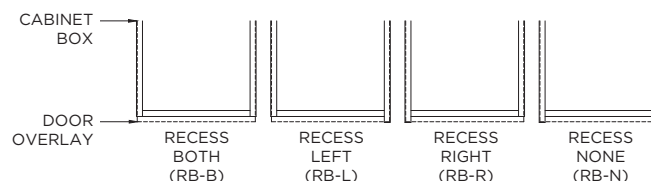



# ELAN MODIFICATIONS

## BOX ONLY

- No interior or exterior parts.
- Standard Interior

ITEM	PRICE
Box Only	Deduct 40%

## CABINET - NO DOORS

- Cabinet Interior Will Be Finished Matching Exterior
- All doors are removed from the cabinet unless a specific section is specified.

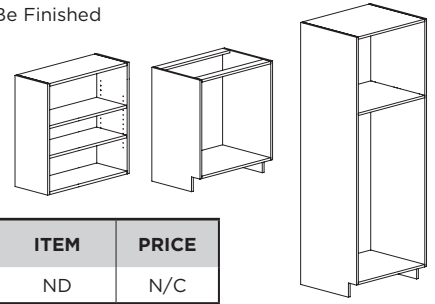

	ITEM	PRICE
Walls, Bases, Talls	ND	N/C

## FLUSH TOE SPACE

- When Specified Cabinet Sides Will Be Flush to Floor And Overlay Toe Base Will be Applied Beneath Doors

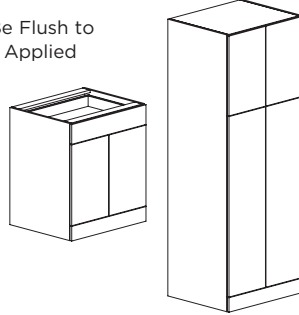

	ITEM	PRICE
Bases, Talls	EFTS	79

## RECESSED TOE ON END OR BACK

- Specify End (L or R or Back)
- Toekick Will be Recessed to Match Standard Toekick

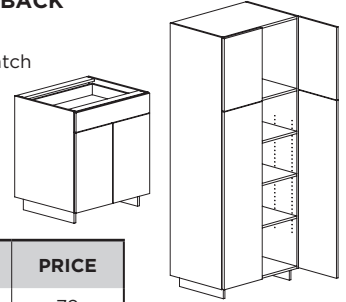

	ITEM	PRICE
Bases, Talls	Recessed Toe	79

## OMIT BOTTOM FLOOR (WALL)

- Bottom Rail and Cabinet Bottom are Omitted.
- Shelves will remain.
- Cabinets with doors will have a 1/4" reveal from bottom.
- If the cabinet has a center stile, a fixed vertical divider will be added for support.

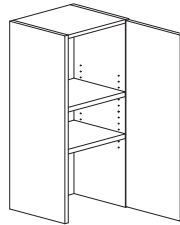

PRICE
227

## TOE SPACE DRAWER

- Touch latch drawer in toe space
- Shipped loose for field installation in toe space.

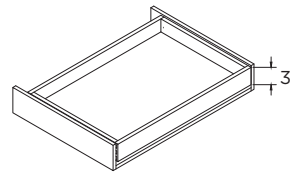

ITEM	PRICE
TSDWR15	417
TSDWR18	433
TSDWR21	450
TSDWR24	468
TSDWR27	454
TSDWR30	500
TSDWR33	519
TSDWR36	535
TSDWR39	552
TSDWR42	570

## OMIT TOE

- Available on Any Cabinet
- Toe is removed and cabinet is 4-1/2" shorter.

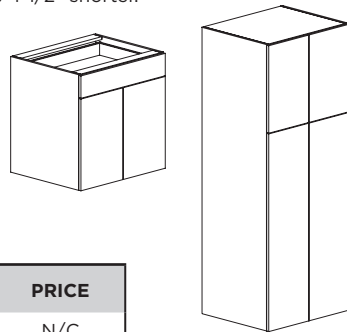

	ITEM	PRICE
Bases, Talls	Omit Toe	N/C

## FIXED VERTICAL DIVIDER

- Unless Specified, Will Be Centered
- Specify Shelves (L or R or Both)

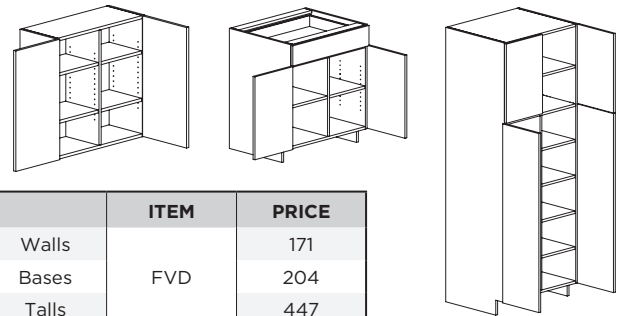

	ITEM	PRICE
Walls		171
Bases	FVD	204
Talls		447

## SHIP SUBTOE LOOSE

- Specify "Ship Subtoe Loose"

	ITEM	PRICE
Bases	Ship Subtoe Loose	79
Talls	Less than 96" High	
	96" High & Above	N/C

# ELAN MODIFICATIONS

## RETRACTABLE DOORS

- Inside opening width is 8" less than cabinet width
- Cabinet must have a minimum depth of 15".
- Doors slide into the cabinet when opened.
- Doors are full inset when closed
- Interior of cabinet is open
- No shelves, center stiles, or dividers.

## RETRACTABLE DOOR OPTION

- Inside opening width is 10" less than cabinet width
- Includes two 3/4" removable dividers
- Shelves optional, specify. (N/C)

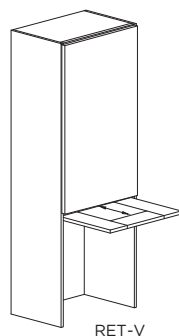

	ITEM	PRICE
Walls	RET	573
Bases	RET-D	934
Talls	RET-V	287

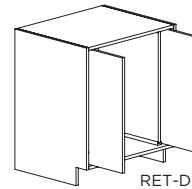
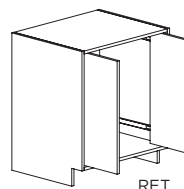

**DESIGN NOTE:** Retractable doors must be fully opened before sliding them back into the cabinet. When closing the doors, fully extend before swinging shut.

## PIPE CHASE

- A Sketch Showing All Dimensions Must be Sent in With The Order

### SPECIFY:

A:      B:      C:      D:

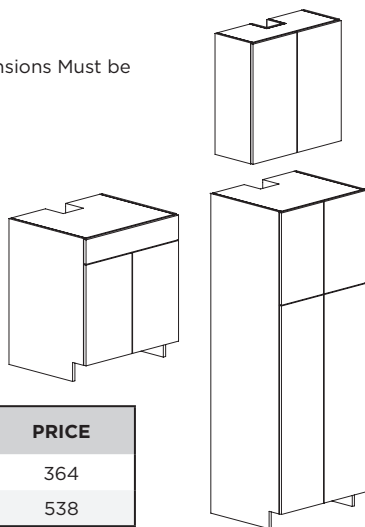
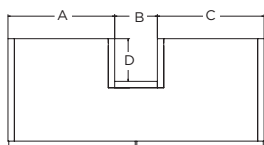

	ITEM	PRICE
Walls, Bases	PC	364
Talls		538

## PENINSULA CABINET

- Depth remains 12" (Wall)
- Specify Functional or Non Functional (Wall)
- Depth Remains 24" (Base & Tall)
- Recessed Toe Front and Peninsula Side (Base & Tall)

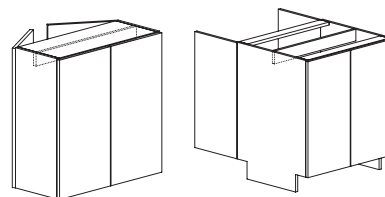

	ITEM	PRICE
Walls, Bases, Talls	Peninsula Cabinet (PEN)	50%

## CONVERT SHELF TO SHELF WITH RAIL

- 3/4" thick plywood shelf with 1-1/2" solid stock on front and back edges. (Replaces Standard Shelf)
- Finished top, bottom and solid stock rails.
- Matches the cabinet interior.
- Not Available in Laminates or Foils

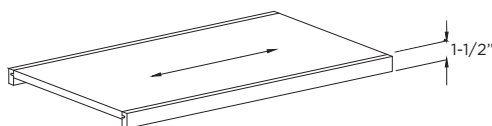

ITEM	PRICE
Shelf with Rail	250/Per Shelf

## CONVERT SHELF TO FURNITURE SHELF

- Two 3/4" thick plywood shelves, attached together with 3/4" thick solid stock on front and back edge. (Replaces Standard Shelf)
- Finished top, bottom, front and back edges.
- SR profile on solid stock
- Matches the cabinet interior
- Not Available in Laminates or Foils

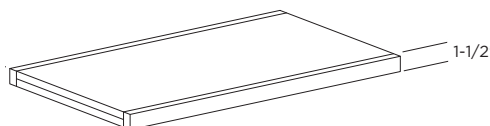

ITEM	PRICE
Furniture Shelf	250/Per Shelf

## WALNUT DRAWER BOXES

- Change any drawer box to Walnut wood. (Natural Finish)
- Available on any standard dovetail drawer box, roll trays, and concealed drawers.
- Available on select drawer box accessories, contact Dealer Services

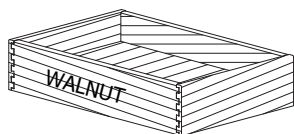

PRICE PER BOX
108

## PLATE GROOVE

- 1/4" x 1/4" groove routed
- 1-1/2" from back of shelf

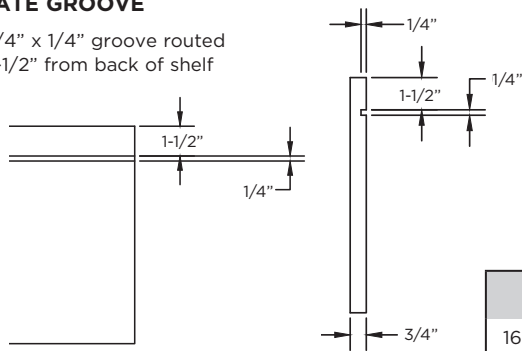

PRICE
160/SHELF

## SPLIT DRAWER

- Changes Single Drawer Into Two drawers

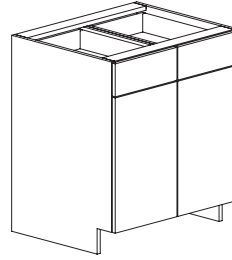

ITEM	PRICE
SPDWR	268

## CUSTOM FRONT ARRANGEMENT

- A sketch showing all dimensions must be sent in with the order.
- For Appliance Cabinets use the Appliance Specification Sheet in the Forms Section of the catalog.

### EXAMPLE PRICING:

Start with the closest cabinet that exists today:

EW1D3648  
 Custom Frame Arrangement  
 Add 1 Fixed Floor  
 Add 1 Drawer 5-1/16" High  
 Finished Interior

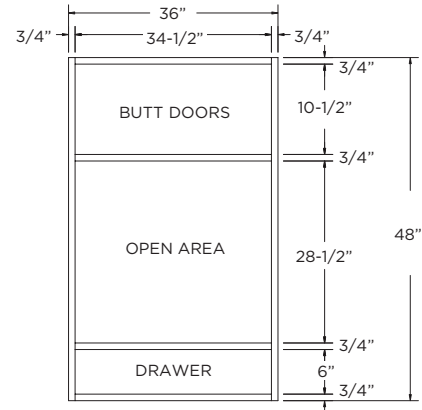

	ITEM	PRICE
Wall Cabinet		318
Base/Bath Cabinet	Custom Front Arrangement	391
Tall Cabinet		896
	Add Floor	43/Sq. Ft.
	Add Drawer	See Chart

DRAWER HEIGHT	CABINET UP TO 24" WIDE	CABINET OVER 24" WIDE
3"	\$319	\$364
4-1/16"	\$331	\$377
5-1/16"	\$344	\$389
6-1/16"	\$356	\$401
7-1/16"	\$368	\$413
9-1/16"	\$392	\$438
12-1/16"	\$429	\$474





**TABLE OF CONTENTS**

**FILLERS/PANELS ..... E1200-1 THRU E1200-10**

Fillers.....	E1200-2
Overlay Filler .....	E1200-2
Angle Filler .....	E1200-2
Corner Filler .....	E1200-2
Corner Overlay.....	E1200-2
Standard Filler with Return.....	E1200-3
Angled Filler with Return .....	E1200-3
End Panel with Filler.....	E1200-3
J-End Panel Filler.....	E1200-4
Box Filler .....	E1200-4
End Panel .....	E1200-5
Overlay End Panel.....	E1200-6
Finished Panels .....	E1200-7
Wainscots .....	E1200-8
Doors Applied to Panels.....	E1200-8
Appliance Panels.....	E1200-9
Refrigerator Panels .....	E1200-10



# ELAN FILLERS & PANELS

## FILLERS

- Exposed Face Matches Job Color
- Over 96" High Not Available in Foil

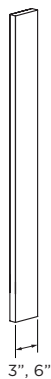

WALL		PRICE
3" Wide		
EFS3	12" up to 30"	40
EFS3	Greater than 30" up to 60"	81
6" Wide		
EFS6	12" up to 30"	66
EFS6	Greater than 30" up to 60"	141

BASE OR VANITY		PRICE
3" Wide		
EFS3	12" up to 30"	40
6" Wide		
EFS6	12" up to 30"	66

TALL		PRICE
3" Wide		
EFS3	Greater than 60" up to 96"	148
EFS3	Greater than 96" up to 120"	300
6" Wide		
EFS6	Greater than 60" up to 96"	243
EFS6	Greater than 96" up to 120"	519

## OVERLAY FILLER

- Includes Filler and Overlay.
- Overlay is profiled on outside edges to match door.
- Over 96" High Not Available in Foil

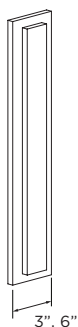

WALL		PRICE
3" Wide		
EFD3	12" up to 30"	79
EFD3	Greater than 30" up to 60"	164
6" Wide		
EFD6	12" up to 30"	134
EFD6	Greater than 30" up to 60"	284

BASE OR VANITY		PRICE
3" Wide		
EFD3	12" up to 30"	79
6" Wide		
EFD6	12" up to 30"	134

TALL		PRICE
3" Wide		
EFD3	Greater than 60" up to 96"	295
EFD3	Greater than 96" up to 120"	612
6" Wide		
EFD6	Greater than 60" up to 96"	485
EFD6	Greater than 96" up to 120"	1028

## ANGLE FILLER

- For designing 3" or 6" angled set back or set forward into a line of cabinetry.
- Not Available in Foil

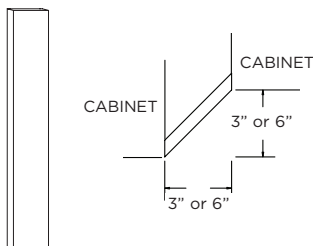

WALL		PRICE
3" x 3" Wide		
EWAF3X3	12" up to 30"	59
EWAF3X3	Greater than 30" up to 60"	154
6" x 6" Wide		
EWAF6X6	12" up to 30"	89
EWAF6X6	Greater than 30" up to 60"	232

BASE OR VANITY		PRICE
3" x 3" Wide		
EBAF3X3	12" up to 30"	59
6" x 6" Wide		
EBAF6X6	12" up to 30"	89

TALL		PRICE
3" Wide		
ETAF3X3	Greater than 60" up to 96"	194
ETAF3X3	Greater than 96" up to 120"	506
6" Wide		
ETAF6X6	Greater than 60" up to 96"	427
ETAF6X6	Greater than 96" up to 120"	1113

## CORNER FILLER

- Exposed Face Matches Job Color

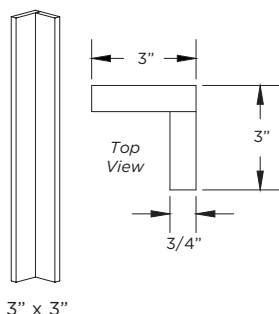

## CORNER OVERLAY

- Top, bottom and outside edges are profiled to match the door.
- Sized to match doors.
- Shipped in 2 pieces, can be trimmed from center, if needed.

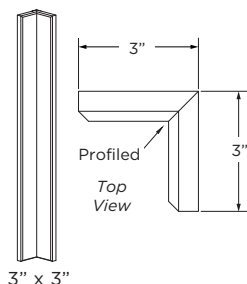

WALL		PRICE
3" x 3" Wide		
EWCF3X3	12" up to 30"	79
EWCF3X3	Greater than 30" up to 60"	290

BASE		PRICE
EBCF3X3	12" up to 30"	79

WALL		PRICE
3" x 3" Wide		
EWCO3X3	12" up to 30"	111
EWCO3X3	Greater than 30" up to 60"	406

BASE		PRICE
EBCO3X3	12" up to 30"	111

# ELAN FILLERS & PANELS

## STANDARD FILLER WITH RETURN

- Exposed Face Matches Job Color
- Specify Height Up to 60"
- Specify Depth

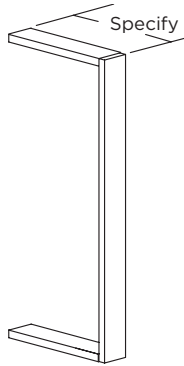

WALL		PRICE
3" Wide		
EFSR3	12" up to 30"	159
EFSR3	Greater than 30" up to 60"	221
6" Wide		
EFSR6	12" up to 30"	191
EFSR6	Greater than 30" up to 60"	253

## ANGLED FILLER WITH RETURN

- 3" Wide
- Specify (L or R)
- Not Available in Foil

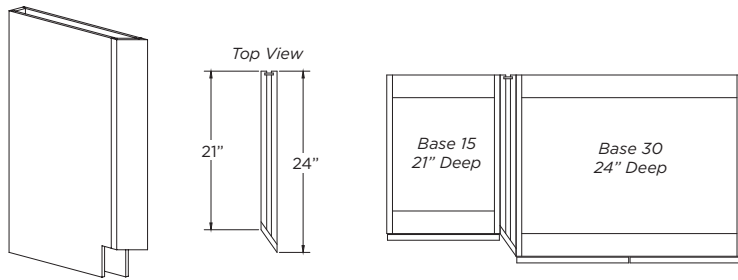

WALL		PRICE
EWAFR	12" up to 30"	216
EWAFR	Greater than 30" up to 60"	457

BASE	PRICE
EBAFR	419

VANITY	PRICE
EVAFR	419

TALL	PRICE
ETAFR3X84	857
ETAFR3X90	1093
ETAFR3X93	1119
ETAFR3X96	1144
ETAFR3X102	1459
ETAFR3X108	1860
ETAFR3X120	2883

## END PANEL WITH FILLER

- Specify Panel (L or R)
- Filler is 3" Wide
- Flush Finished End
- Specify FTS (Flush Toe Space), No Charge
- Over 96" High Not Available in Foil

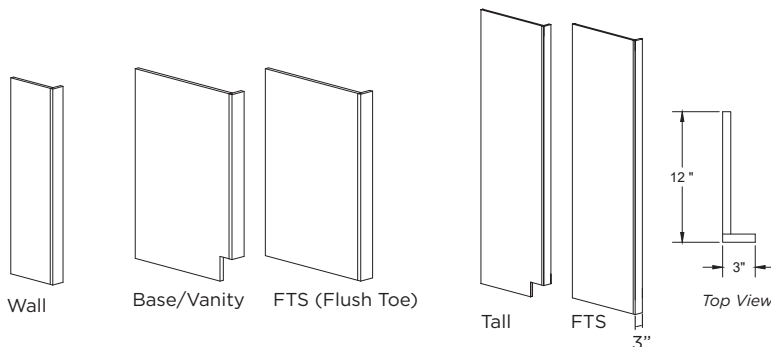

WALL		PRICE
12" DEEP		
EWEPF3	12" up to 30"	148
EWEPF3	Greater than 30" up to 60"	285

BASE	PRICE
24" DEEP	
EBEPF3	229

VANITY	PRICE
21" DEEP	
EVEPF3	229

TALL	PRICE
24" DEEP	
ETEPF3X84	539
ETEPF3X90	600
ETEPF3X93	614
ETEPF3X96	628
ETEPF3X102	699
ETEPF3X108	778
ETEPF3X120	906
27" DEEP	
ETEPF3X8427	642
ETEPF3X9027	685
ETEPF3X9327	700
ETEPF3X9627	712
ETEPF3X10227	781
ETEPF3X10827	860
ETEPF3X12027	984

# ELAN FILLERS & PANELS

## J-END PANEL FILLERS

- J Panels are designed to be flush with the door and 7/8" deeper than the cabinet.
- Specify Panel (L or R)
- 3" Wide
- Finished on Both Sides and Front
- Flush Finished Ends
- Flush Toe is standard. Specify Toe Notch if needed, No Charge.
- Over 96" High Not Available in Foil

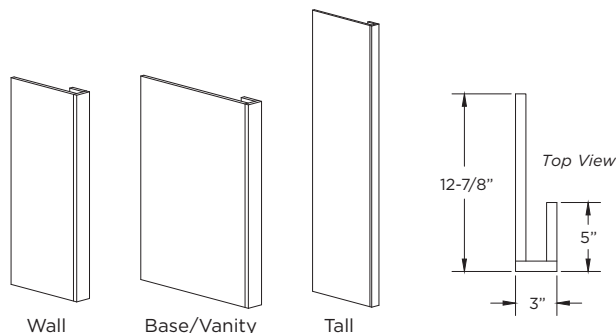

WALL		PRICE
12-7/8" DEEP		
EWE PJF3	12" up to 30"	198
EWE PJF3	Greater than 30" up to 60"	335

BASE	PRICE
24-7/8" DEEP	
EBE PJF3	279

VANITY	PRICE
21-7/8" DEEP	
EVE PJF3	279

TALL	PRICE
24-7/8" DEEP	
ETE PJF3X84	589
ETE PJF3X90	650
ETE PJF3X93	664
ETE PJF3X96	678
ETE PJF3X102	749
ETE PJF3X108	828
ETE PJF3X120	956
27-7/8" DEEP	
ETE PJF3X8427	687
ETE PJF3X9027	731
ETE PJF3X9327	746
ETE PJF3X9627	758
ETE PJF3X10227	807
ETE PJF3X10827	859
ETE PJF3X12027	971

## BOX FILLER

- 3" Wide
- Panel Both Sides
- Flush Finished Panel on Both Sides
- Specify FTS (Flush Toe Space), No Charge
- Over 96" High Not Available in Foil

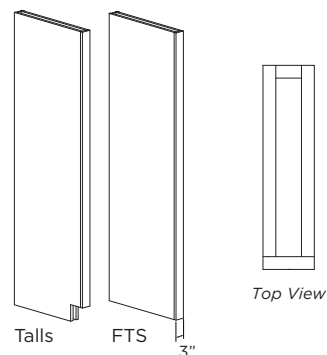
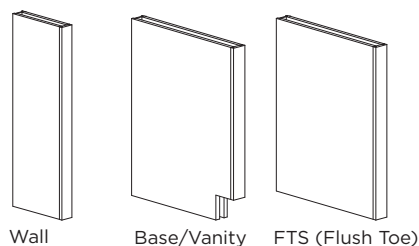

WALL		PRICE
12" DEEP		
EWB XF3	12" up to 30"	347
EWB XF3	Greater than 30" up to 60"	565

BASE	PRICE
24" DEEP	
EBB XF3	413
EBB XF3FTS	

VANITY	PRICE
21" DEEP	
EVB XF3	413

TALL	PRICE
24" DEEP	
ETB XF84	1082
ETB XF90	1194
ETB XF93	1223
ETB XF96	1251
ETB XF102	1381
ETB XF108	1525
ETB XF120	1842
27" DEEP	
ETB XF8427	1223
ETB XF9027	1334
ETB XF9327	1362
ETB XF9627	1390
ETB XF10227	1334
ETB XF10827	1456
ETB XF12027	1721



## END PANEL

- 3/4" Thick
- Front Edge Banded
- Finished on Both Sides
- Over 96" High Not Available in Foil

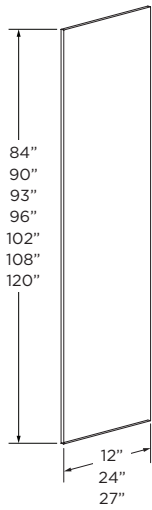

Talls

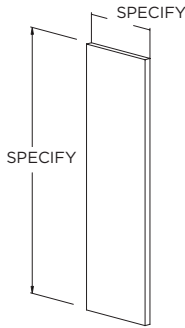

Walls

WALL	PRICE
EWEP 12" up to 30"	142
EWEP Greater than 30" up to 60"	226

BASE	PRICE
EBEPS	205
EBEPA	237
EBEPT	260

TALL	PRICE
12" Deep	
EREPI284	311
EREPI290	351
EREPI293	361
EREPI296	368
EREPI2102	381
EREPI2108	394
EREPI2120	422
24" Deep	
EREPI2484	543
EREPI2490	594
EREPI2493	608
EREPI2496	622
EREPI24102	651
EREPI24108	682
EREPI24120	745
27" Deep	
EREPI2784	628
EREPI2790	675
EREPI2793	697
EREPI2796	718
EREPI27102	764
EREPI27108	813
EREPI27120	917

- Specify Height and Depth
- Specify 4-1/2" or 6-1/8"

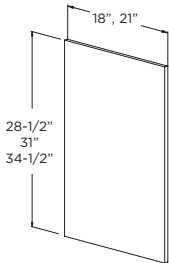

STRAIGHT

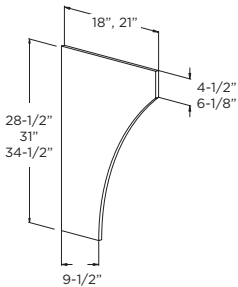

ARCHED

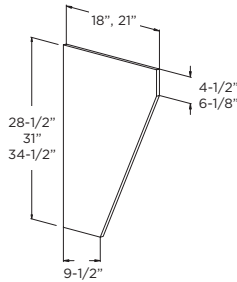

TAPERED

# ELAN FILLERS & PANELS

## OVERLAY END PANEL

- Specify left or right
- Specify Peninsula (POEP)
- Overlay End Panel is 3/4" plywood panel and finished both sides
- Designed to be flush with the face of the door (7/8" deeper than cabinet depth).
- Front edge banded and finished to match order
- Recessed toe notch is standard. Specify Flush Toe Space if needed, no charge.
- Shipped loose for field installation
- Over 96", not available in Foil.

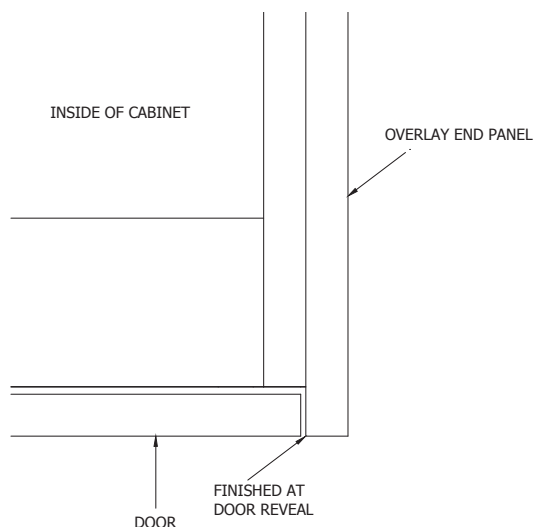
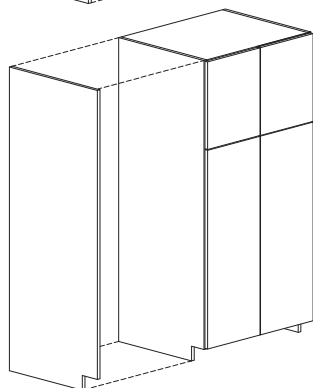
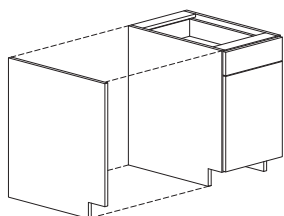
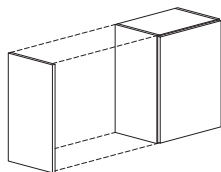

TALL	PRICE
ETOEP1284	374
ETOEP2484	652
ETOEP1290	422
ETOEP2490	713
ETOEP1293	434
ETOEP2493	730
ETOEP1296	442
ETOEP2496	747
ETOEP12102	458
ETOEP24102	782
ETOEP12108	473
ETOEP24108	819
ETOEP12120	507
ETOEP24120	894

WALL	PRICE
EWOEP1230	171
EWOEP1233	184
EWOEP1236	197
EWOEP1239	210
EWOEP1242	222
EWOEP1248	235
EWOEP1254	247
EWOEP1257	260
EWOEP1260	272

BASE	PRICE
EBOEP12	192
EBOEP24	285

VANITY	PRICE
EVOEP18	230
EVOEP21	249
EVOEP18T	242
EVOEP21T	266

CABINET DEPTH	OEP DEPTH
12"	12-7/8"
18"	18-7/8"
21"	21-7/8"
24"	24-7/8"

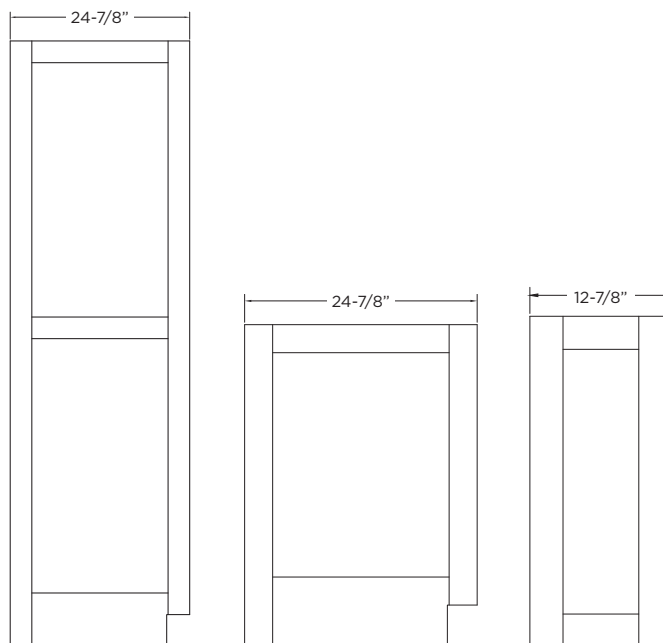

## PANELED END MODIFICATION:

	ITEM	PRICE
Walls	PEC-W 12" - 27"H	159
	PEC-W 30" - 48"H	199
	PEC-W 52-1/2" - 66"H	279
Bases	PEC-B	318
Talls	PEC-T 12" Deep	449
	PEC-T 24" Deep	597

**DESIGN NOTE:** For paneled end add PEC Modification.

## FINISHED PANELS

- 1/4" or 3/4" thick

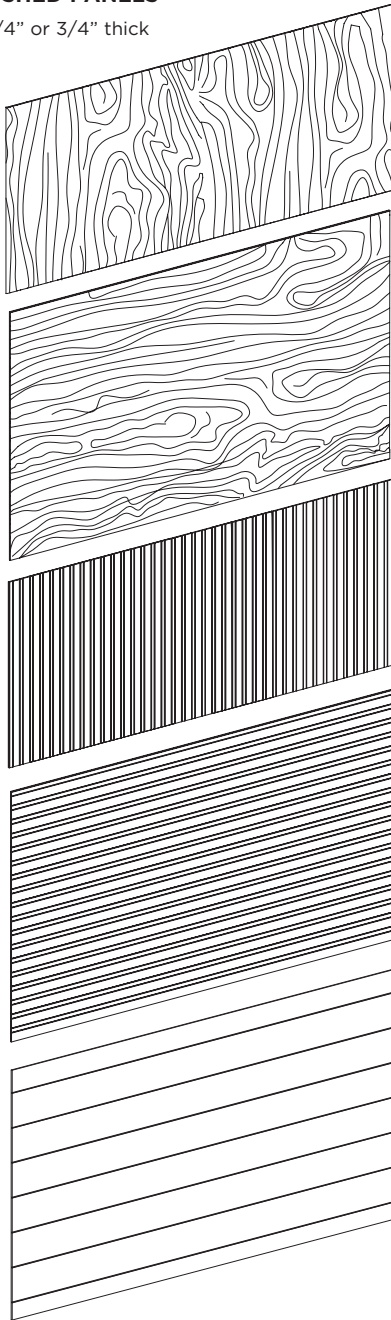

### VERTICAL GRAIN

### HORIZONTAL GRAIN

### GROOVED VERTICAL GRAIN

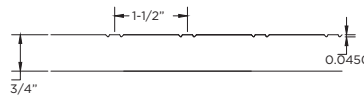

### GROOVED HORIZONTAL GRAIN

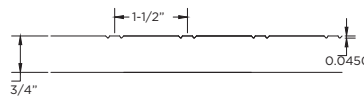

### SHIPLAP HORIZONTAL GRAIN

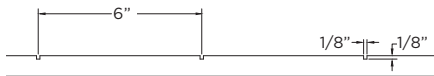

VERTICAL GRAIN	PRICE
<b>34-1/2" HIGH X 48" WIDE</b>	
FP(V)3448x1/4	213
FP(V)3448x3/4	268
<b>34-1/2" HIGH X 96" WIDE</b>	
FP(V)3496x1/4	426
FP(V)3496x3/4	533
<b>48" HIGH X 96" WIDE</b>	
FP(V)4896x1/4	668
FP(V)4896x3/4	836

HORIZONTAL GRAIN	PRICE
<b>34-1/2" HIGH X 48" WIDE</b>	
FP(H)3448x1/4	213
FP(H)3448x3/4	268
<b>34-1/2" HIGH X 96" WIDE</b>	
FP(H)3496x1/4	362
FP(H)3496x3/4	439
<b>48" HIGH X 96" WIDE</b>	
FP(H)4896x1/4	413
FP(H)4896x3/4	581

GROOVED VERTICAL	PRICE
<b>34-1/2" HIGH X 48" WIDE</b>	
FPG(V)3448x1/4	239
FPG(V)3448x3/4	294
<b>34-1/2" HIGH X 96" WIDE</b>	
FPG(V)3496x1/4	400
FPG(V)3496x3/4	478
<b>48" HIGH X 96" WIDE</b>	
FPG(V)4896x1/4	452
FPG(V)4896x3/4	620

GROOVED HORIZONTAL	PRICE
<b>34-1/2" HIGH X 96" WIDE</b>	
FPG(H)3496x1/4	400
FPG(H)3496x3/4	478
<b>48" HIGH X 96" WIDE</b>	
FPG(H)4896x3/4	620

SHIPLAP	PRICE
<b>34-1/2" HIGH X 96" WIDE</b>	
FPS(H)3496x1/4	400
FPS(H)3496x3/4	478
<b>48" HIGH X 96" WIDE</b>	
FPS(H)4896x3/4	620

### OPTIONS:

#### EDGE BANDING

- 3/4" Thick Only
- Specify Which Edges to Band

#### CUT TO SIZE

- Specify Horizontal or Vertical Grain
- Specify Width and Height

EDGE BANDING	PRICE
Loose	4/LINEAL FT
Applied	16/LINEAL FT

FINISHED PANEL CUT TO SIZE	PRICE
1/4" Thick	24/SQ. FT.
3/4" Thick	49/SQ. FT.

GROOVED FINISHED PANEL CUT TO SIZE	PRICE
1/4" Thick	59/SQ. FT.
3/4" Thick	83/SQ. FT.

SHIPLAP	PRICE
1/4" Thick	59/SQ. FT.
3/4" Thick	83/SQ. FT.

# ELAN FILLERS & PANELS

## PANELED WAINSCOTING

- 3" framing with 7-1/2" bottom rail (3" bottom rail available specify)
- Paneled wainscot has 3" stiles/rails and matches the door style profile and panel.
- Frame will be Mortised & Tenon Joint Construction

## SQUARE PANEL WAINSCOTS

- Maximum overall size: 42" High X 96" Wide.
- Minimum overall size: 12" High X 12" Wide.

## ARCHED PANEL WAINSCOTS

- Maximum overall size: 42" High X 96" Wide.
- Minimum overall size: 15" High X 12" Wide.

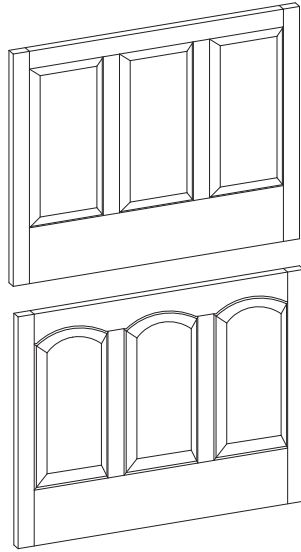

ITEM	PRICE
Square	55/SQ. FT. +\$94/PANEL
Arched	55/SQ. FT. +\$165/PANEL
Molding Attached	55/SQ. FT. +\$165/PANEL

WIDTH	# OF PANELS
26" or Less	1
Over 26" up to 45"	2
Over 45" up to 63"	3
Over 63" up to 84"	4
Over 84" up to 96"	5

## CUSTOM PANELED WAINSCOTS

- Include sketch of all widths and heights of rails, stiles, and panels.
- Insert Panel Width Should Not Exceed 20-1/16"
- Maximum Overall Size 42"H X 96"W
- Frame will be Mortised & Tenon Joint Construction

ITEM	PRICE
Priced Under \$550	ADD 60%
Priced \$550 Or More:	ADD 30%

## DOORS APPLIED TO PANEL

- Doors are mounted on 1/4", 1/2", or 3/4" thick panel.
- Grain direction on panel is vertical with a maximum width of 96" and maximum height of 48".
- Optional edge banding is available on 1/2" or 3/4" thick panels only, must specify. (\$16/LINEAL FT.)

ITEM	PRICE
DAP1/4	24/SQ. FT. + \$130/DOOR
DAP1/2	37/SQ. FT. + \$130/DOOR
DAP3/4	49/SQ. FT. + \$130/DOOR

WIDTH	# OF DOORS
24" or Less	1
Over 24" up to 48"	2
OVER 48" UP TO 73"	3
OVER 73" UP TO 96"	4

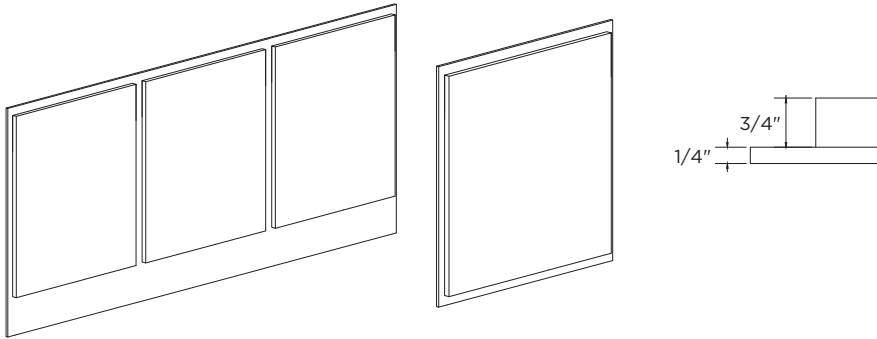

## TRU-BEAD WAINSCOTING

- Maximum Overall Size: 48" High X 96" Wide
- Specify Width And Height
- Specify 3" or 6"

ITEM	PRICE
Tru-Bead Wainscot	68/SQ. FT.

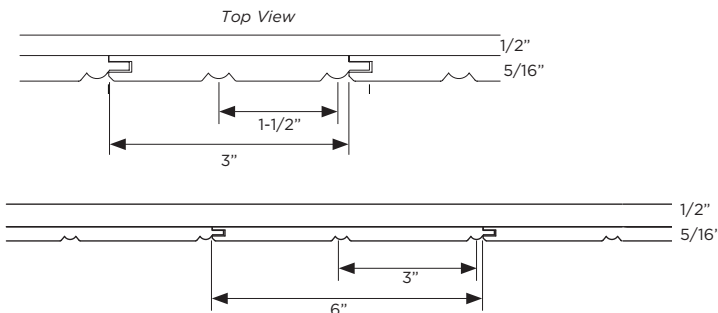
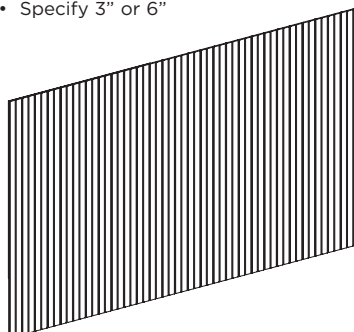

## APPLIANCE PANELS

- Dishwasher Or Compactor Panels (1 or 2 Pieces)
- Appliance Specification Sheet Must Accompany Order (Located in the Forms Section of the Catalog)

ITEM	PRICE
APD	61/SQ. FT.
APE	112/SQ. FT.

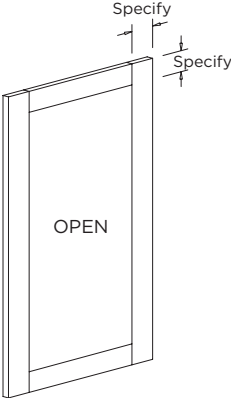

### WINE STORAGE FRAME (APD)

- Door Frame Only  
(Outside edge will have the same profile as the door style, inside edge profile is square)
- Center Area Open
- Specify Width and Height of Door Frame
- Specify Rail and Stile Width  
(Mitered Door Styles need both stile and rail to be the same size)

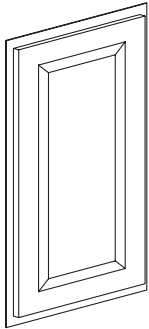

### STYLE E (APE)

- Deluxe Door Style Panel With Custom Reveals
- Specify Width and Height of 1/4" Panel and 3/4" Deluxe Door Style Panel(s)
- To be field applied. Shipped separate.

# ELAN FILLERS & PANELS

## REFRIGERATOR DOOR PANELS

- 1, 2, 3, or 4 pieces - Specify Panel Sizes
- Appliance Specification Sheet Must Accompany Order (Located in the Forms Section of the Catalog)

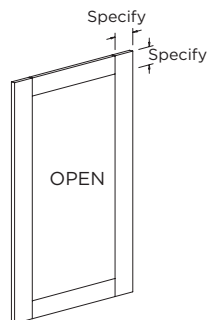

### STYLE D (RDPD)

- Door Frame Only  
(Outside edge will have the same profile as the door style, inside edge profile is square)
- Center Area Open
- Specify Width and Height of Door Frame
- Specify Rail and Stile Width  
(Mitered Door Styles need both stile and rail to be the same size)

ITEM	PRICE
RDPD	61/SQ. FT.
RDPE	112/SQ. FT.

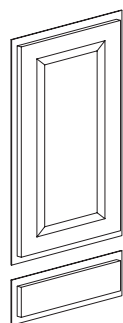

### STYLE E (RDPE)

- Deluxe Door Style Panel With Custom Reveals
- Specify Width and Height of 1/4" Panel, 3/4" Deluxe Door Style Panel (s), and Option 1, 2, 3, or 4
- To be Field Applied
- Shipped Separate
- Note: Single Panel Doors over 26" wide or 48" high will have no warranty.

## MORTISE & TENON DOOR STYLE PARAMETERS

- Doors up to 26" wide default to a single panel door.
- Doors over 26" wide and larger default to a horizontal double panel door.
- Doors up to 48" high default to a single panel door.
- Doors over 48" high and larger default to a vertical double panel door.

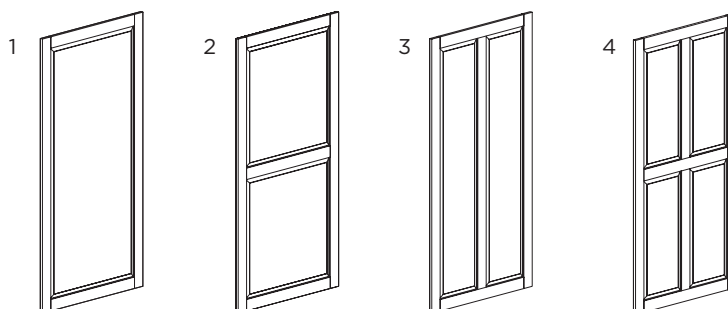

## MITERED DOOR STYLE PARAMETERS

- Doors up to 26" wide default to a single panel door.
- Doors over 26" wide and larger default to horizontal double doors.
- Doors up to 48" high default to a single panel door.
- Doors over 48" high and larger default to vertical double doors.

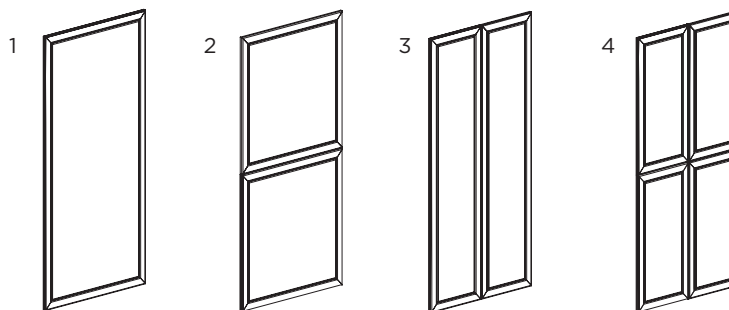



**TABLE OF CONTENTS**

**MOLDINGS/MISCELLANEOUS ..... E1300-1 THRU E1300-13**

Batten Molding/Scribe Molding.....	E1300-2
Chair Rail Molding.....	E1300-2
Deluxe Cove Molding.....	E1300-2
Countertop Edge Trim.....	E1300-2
Inside/Outside Corner Molding.....	E1300-2
Shoe Molding/Quarter Round Molding.....	E1300-2
Recessed Bottom Light Rail.....	E1300-2
Crown Moldings.....	E1300-3
Molding Cleats and Spacers.....	E1300-3
Plywood Trim Molding.....	E1300-3
Mirror Molding.....	E1300-3
Molded Light Rail/Square Light Rail.....	E1300-4
Solid Stock.....	E1300-4
Square 4 Sides A/Square 4 Sides B.....	E1300-4
Tru-Bead Molding.....	E1300-4
Flush Trim Molding.....	E1300-4
Starter Molding.....	E1300-4
Furniture Base Molding.....	E1300-5
Standard Toekick.....	E1300-5
Deluxe Touch Up Kit.....	E1300-5
Phenolic Skins/Pliant Skins.....	E1300-5
Glides/Hinges.....	E1300-5
Doors/Drawer Fronts.....	E1300-5
Stain and Glaze.....	E1300-5
Arched Paneled Valance/Square Paneled Valance.....	E1300-6
Toekick Valances/Valances.....	E1300-7
Wood Top/Shelving.....	E1300-8
Furniture Shelf/Shelf with Rail.....	E1300-9
Turned Posts.....	E1300-10
Architectural Posts.....	E1300-11
Wood Legs/Metal Legs.....	E1300-12
Countertop Wood Support.....	E1300-12
MCA68.....	E1300-12
Casters.....	E1300-12
Foil Moldings.....	E1300-13



# MOLDINGS/MISCELLANEOUS

ALL 96" MOLDING LENGTHS MAY BE FILLED WITH LENGTHS FROM 92" TO 102".

## BATTEN MOLDING

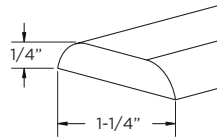

ITEM	PRICE
BM48	32
BM96	62

## SCRIBE MOLDING

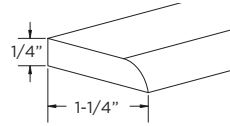

ITEM	PRICE
SM48	32
SM96	62

## CHAIR RAIL MOLDING

3/4" X 1/4" Notch

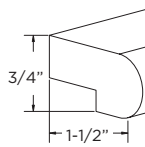

CONTEMPORARY	PRICE
CRM-C3/4X48	50
CRM-C3/4X96	126

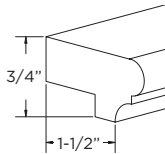

TRADITIONAL	PRICE
CRM-T3/4X48	50
CRM-T3/4X96	126

## DELUXE COVE MOLDING

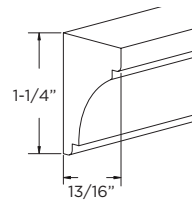

ITEM	PRICE
DCM48	32
DCM96	81

## MINI DELUXE COVE MOLDING

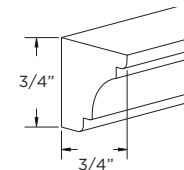

ITEM	PRICE
MDCM48	32
MDCM96	81

## COUNTERTOP EDGE TRIM

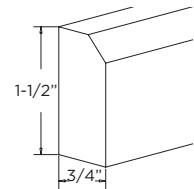

BEVEL	PRICE
CET-B48	38
CET-B96	100

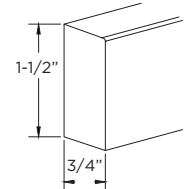

ROUND	PRICE
CET-SR48	38
CET-SR96	100

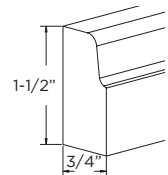

OGEE	PRICE
CET-OG48	38
CET-OG96	100

## INSIDE CORNER MOLDING

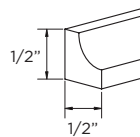

ITEM	PRICE
CBM011-48	32
CBM011-96	62

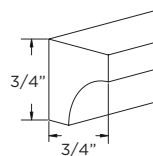

ITEM	PRICE
CBM012-48	32
CBM012-96	62

## OUTSIDE CORNER MOLDING

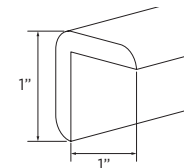

ITEM	PRICE
OSC48	44
OSC96	87

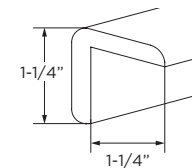

ITEM	PRICE
OSC48-1	59
OSC96-1	117

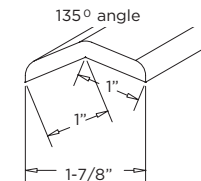

ITEM	PRICE
OSCA48	94
OSCA96	177

## SHOE MOLDING

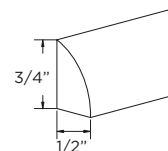

ITEM	PRICE
CBS011-48	32
CBS011-96	56

## SQUARE SHOE MOLDING

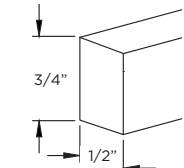

ITEM	PRICE
MCS1/2-48	32
MCS1/2-96	62

## QUARTER ROUND MOLDING

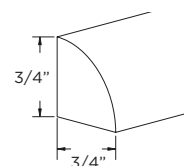

ITEM	PRICE
CBS012-48	32
CBS012-96	56

## RECESSED BOTTOM LIGHT RAIL

- 8' Lengths
- 3/4" x 3", edgelanded and finished

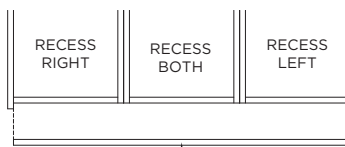
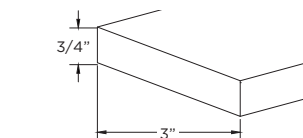

RECESSED BOTTOM LIGHT RAIL

ITEM	PRICE
RBLR 8' Lengths	148 Each

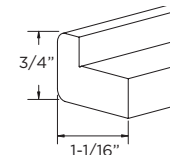

ITEM	PRICE
CBB012-48	44
CBB012-96	87



# MOLDINGS/MISCELLANEOUS

ALL 96" MOLDING LENGTHS MAY BE FILLED WITH LENGTHS FROM 92" TO 102".

## CROWN MOLDING

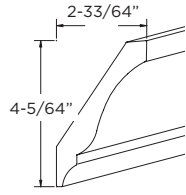

CR1612	PRICE
CR1612-48	75
CR1612-96	188

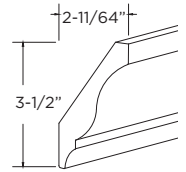

CR1614	PRICE
CR1614-48	65
CR1614-96	163

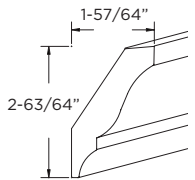

CR1613	PRICE
CR1613-48	55
CR1613-96	137

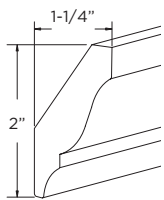

CR1011	PRICE
CR1011-48	50
CR1011-96	131

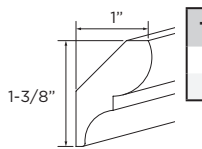

TRADITIONAL	PRICE
T1M48	40
T1M96	100

## CROWN MOLDING - COVE

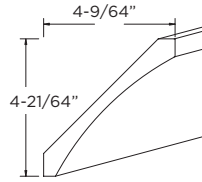

CR1211	PRICE
CR1211-48	95
CR1211-96	238

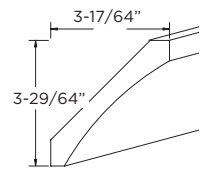

CR1212	PRICE
CR1212-48	75
CR1212-96	188

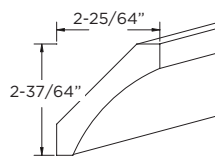

CR1213	PRICE
CR1213-48	55
CR1213-96	137

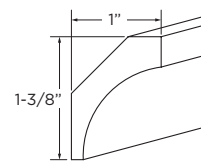

COVE	PRICE
P1M48	40
P1M96	100

## CROWN MOLDING - CRAFTSMAN

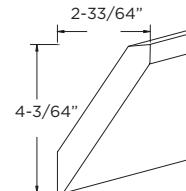

CR1312	PRICE
CR1312-48	75
CR1312-96	188

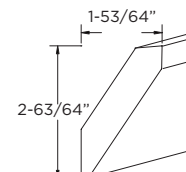

CR1313	PRICE
CR1313-48	55
CR1313-96	137

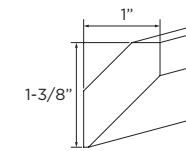

BEVEL	PRICE
Y1M48	40
Y1M96	100

## CROWN MOLDING - BEADED COVE

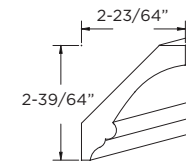

CR1413	PRICE
CR1413-48	55
CR1413-96	137

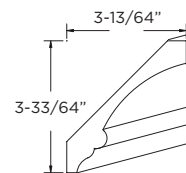

CR1412	PRICE
CR1412-48	75
CR1412-96	188

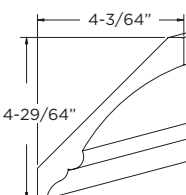

CR1411	PRICE
CR1411-48	95
CR1411-96	238

## MOLDING CLEATS/SPACER

- Finished on 3 sides.

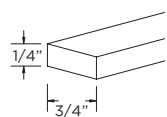

ITEM	PRICE
MCS1/4-48	32
MCS1/4-96	62

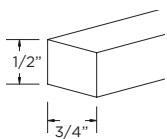

ITEM	PRICE
MCS1/2-48	32
MCS1/2-96	62

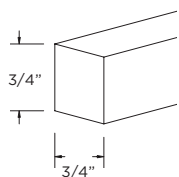

ITEM	PRICE
MCS3/4-48	32
MCS3/4-96	62

## PLYWOOD TRIM MOLDING

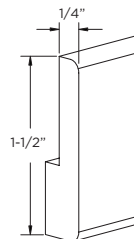

ITEM	PRICE
PTM48	32
PTM96	62

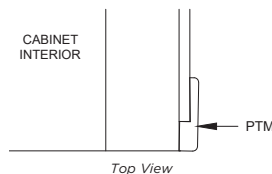

## MIRROR MOLDING

- Specify Profile OG or SR

ITEM	PRICE
MM48	70
MM96	143

OG

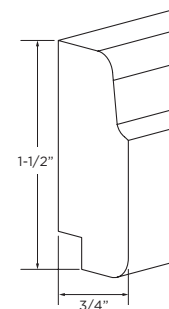

SR

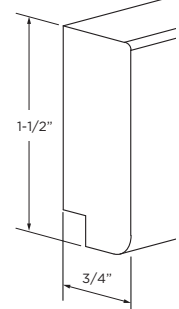

Mirror Molding shipped in lengths to be installed in field to overlap mirror.

# MOLDINGS/MISCELLANEOUS

ALL 96" MOLDING LENGTHS MAY BE FILLED WITH LENGTHS FROM 92" TO 102".

## MOULDED LIGHT RAIL

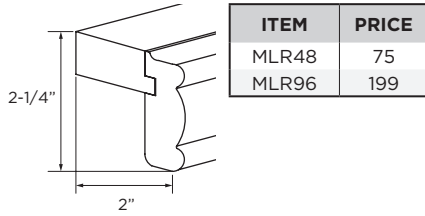

## SQUARE LIGHT RAIL

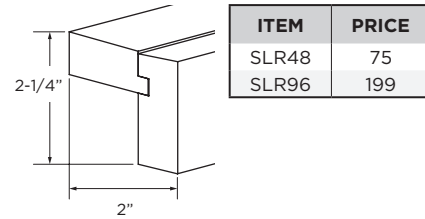

## SOLID STOCK

**A** - All edges and front side are finished.  
**B** - All edges and sides are finished.  
 Maximum Width: 25"  
 Maximum Length: \*96" - 144"

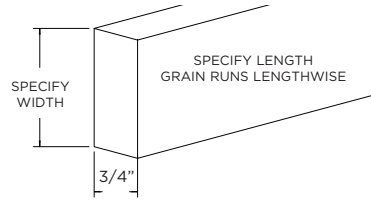

ITEM	PRICE
SOLID STOCK A	\$87/SQ. FT
SOLID STOCK B	\$131/SQ. FT

## SQUARE 4 SIDES A

- 3/4" Solid Wood
- All edges and front side are finished.

ITEM	PRICE
S4S2X48A	50
S4S4X48A	100
S4S6X48A	152
S4S2X96A	100
S4S4X96A	202
S4S6X96A	303

## SQUARE 4 SIDES B

- 3/4" Solid Wood
- All edges and sides are finished.

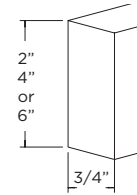

ITEM	PRICE
S4S2X48B	76
S4S4X48B	150
S4S6X48B	227
S4S2X96B	150
S4S4X96B	303
S4S6X96B	455

## TRU-BEAD MOLDING

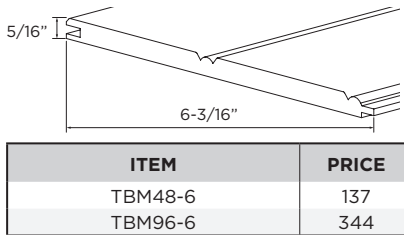
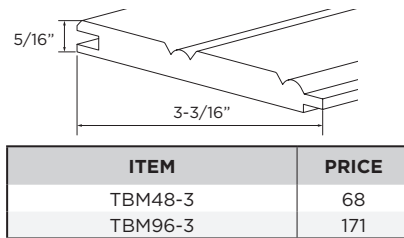

**Design Note:** Shipped in individual pieces. To be attached together on jobsite.

## FLUSH TRIM MOLDING

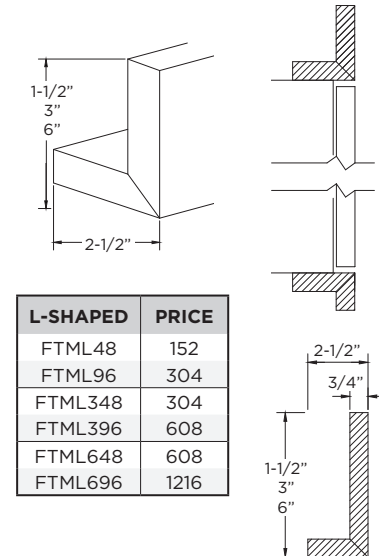
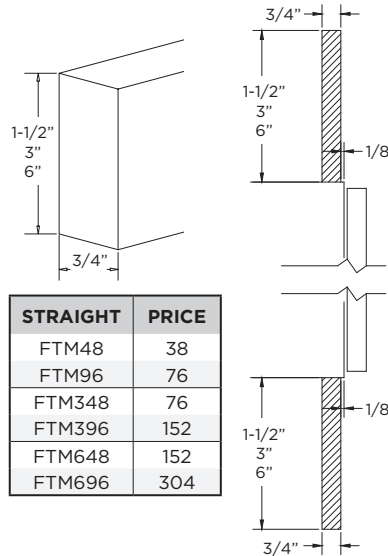

## STARTER MOLDING

- Starter molding is designed as a "build up" for attachment of Crown molding to maintain reveals
- Specify edge profile. If not specified, SR is used.

Profile Options:

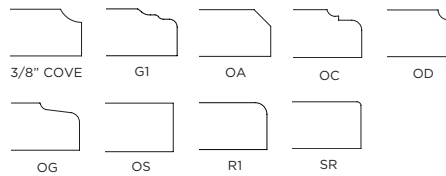

## MP

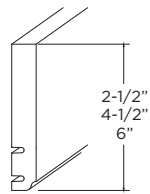

MP4	PRICE
MP248	69
MP296	137
MP448	124
MP496	247
MP648	179
MP696	357

## SMPF

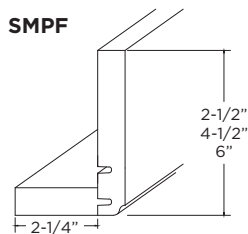

SMPF	PRICE
SMPF248	123
SMPF296	245
SMPF448	170
SMPF496	339
SMPF648	217
SMPF696	433

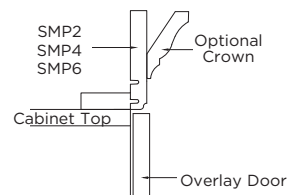

## FURNITURE BASE MOLDINGS

### OG PROFILE

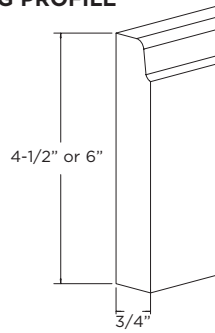

ITEM	PRICE
FBM-T48	70
FBM-T6X48	164
FBM-T96	103
FBM-T6X96	257

### SR PROFILE

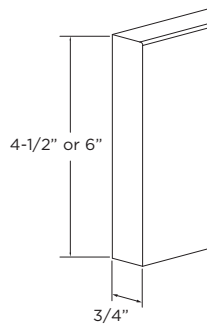

ITEM	PRICE
FBM-SR48	70
FBM-SR6X48	164
FBM-SR96	103
FBM-SR6X96	257

### OC PROFILE

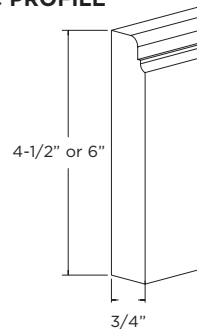

ITEM	PRICE
FBM-OC48	70
FBM-OC6X48	164
FBM-OC96	103
FBM-OC6X96	257

### OD PROFILE

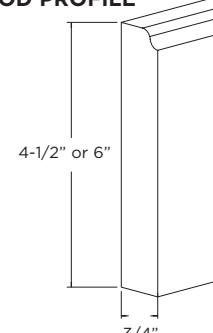

ITEM	PRICE
FBM-OD48	70
FBM-OD6X48	164
FBM-OD96	103
FBM-OD6X96	257

### STANDARD TOEKICK

- 3/4" thick matching the wood specie of the cabinet ordered. Supplied in 4-1/2" X 96" lengths at no charge per order.
- Extra toekick is available in 4-1/2"W X 48"H or 4-1/2"W X 96"H lengths.

ITEM	PRICE
TOEKICK48	34
TOEKICK96	67

### DELUXE TOUCH UP KIT (TUK-D)

- Premium Furniture Polish
- Water Based Top Coat
- (1) Stain Marker
- (1) Stain Wax Pencil
- Bumper Pads

ITEM	PRICE
TUK-D	95
Touch Up Marker Only	24

### PHENOLIC SKINS

- 1/16" Thick, 24"W (Max.) 96"H (Max.)
- Apply with contact cement

ITEM	PRICE
Phenolic Skins	32/SQ. FT.

### PLIANT SKINS

- 1/32" Thick, 24"W (Max.), 96"H (Max.)
- Self Adhesive
- Not Available with Solid Colors

ITEM	PRICE
Pliant Skins	32/SQ. FT.

### HINGE RESTRICTOR CLIP

- Restricts opening angle of hinge to 86 degrees.
- Detach the door from the frame. Click the hinge to the closed position. Insert the restrictor clip into the base of the hinge arm. Rotate the hinge to the open position. Re-attach the hinge to the frame.

ITEM	PRICE
Hinge Restrictor Clip	4

### ROLLTRAY GLIDES

- Full Extension Undermount

ITEM	PRICE
Full Extension Soft Motion	73/Set

### DRAWER GLIDES

- Softmotion Undermount Full Extension
- See page G2 for more information

ITEM	PRICE
Full Extension Soft Motion	73/Set

### HINGES

- Soft Close Concealed Hinge System

ITEM	PRICE
Soft Close	15
Without Soft Close	11

### DOOR(S)

- Specify Hinge Rout, if needed
- Specify cabinet size and factory will size accordingly or specify custom size as needed.
- Limitations vary per door style. Exceeding limitations may void warranty.

ITEM	PRICE
Slab	87/SQ. FT.
Standard	56/SQ. FT. + 71/PANEL
Molding Attached	56/SQ. FT. + 134/PANEL
Curved	Call Factory

### DRAWER FRONT(S)

- Standard Size. Specify Cabinet. (Factory Will Size Accordingly)

ITEM	PRICE
Slab	87/SQ. FT.
5 Piece	56/SQ. FT. + 71/PANEL
Molding Attached	56/SQ. FT. + 134/PANEL

### STAIN AND GLAZE

- Available in Quarts and Gallons

STAIN	PRICE
Quart	86
Gallon	208

GLAZE	PRICE
Quart	171
Gallon	414

# MOLDINGS/MISCELLANEOUS

## ARCHED PANELED VALANCE

- Paneled Valance has 3" stiles/rails and matches the door style profile and panel.
- Frame will be Mortised & Tenon Joint Construction

**DESIGN NOTE:** Door styles with molding will not have molding applied.

**Modifications:** Limited - CALL FACTORY FOR AVAILABILITY AND QUOTE

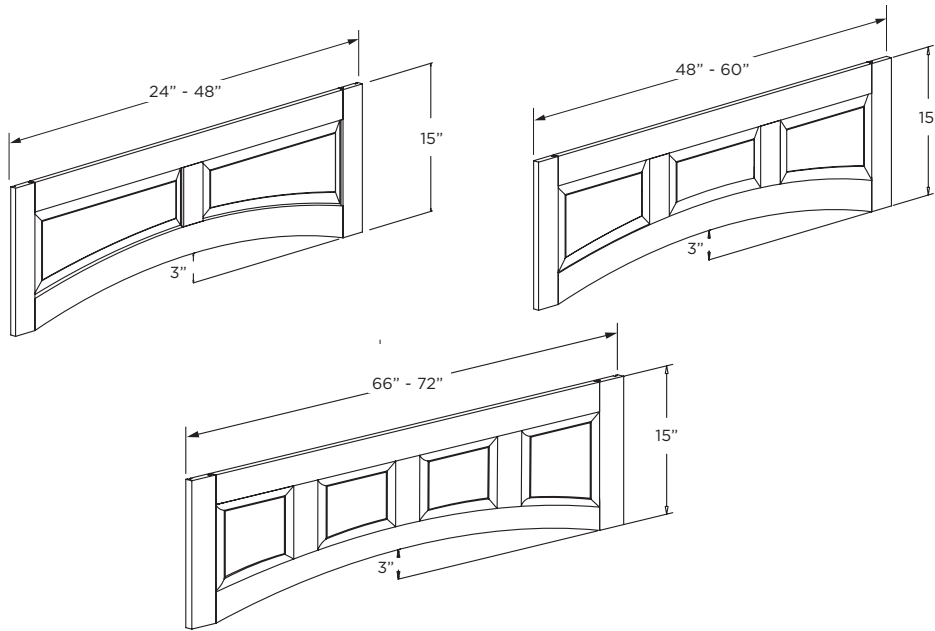

15" HIGH	PRICE
ARPV2415	702
ARPV2715	789
ARPV3015	878
ARPV3315	963
ARPV3615	1053
ARPV3915	1139
ARPV4215	1226
ARPV4515	1314
ARPV4815	1401

15" HIGH	PRICE
ARPV4815-3	1401
ARPV6015-3	1791

15" HIGH	PRICE
ARPV6615-4	1822
ARPV7215-4	2329

## SQUARE PANELED VALANCE

- Paneled Valance has 3" stiles/rails and matches the door style profile and panel.
- Frame will be Mortised & Tenon Joint Construction

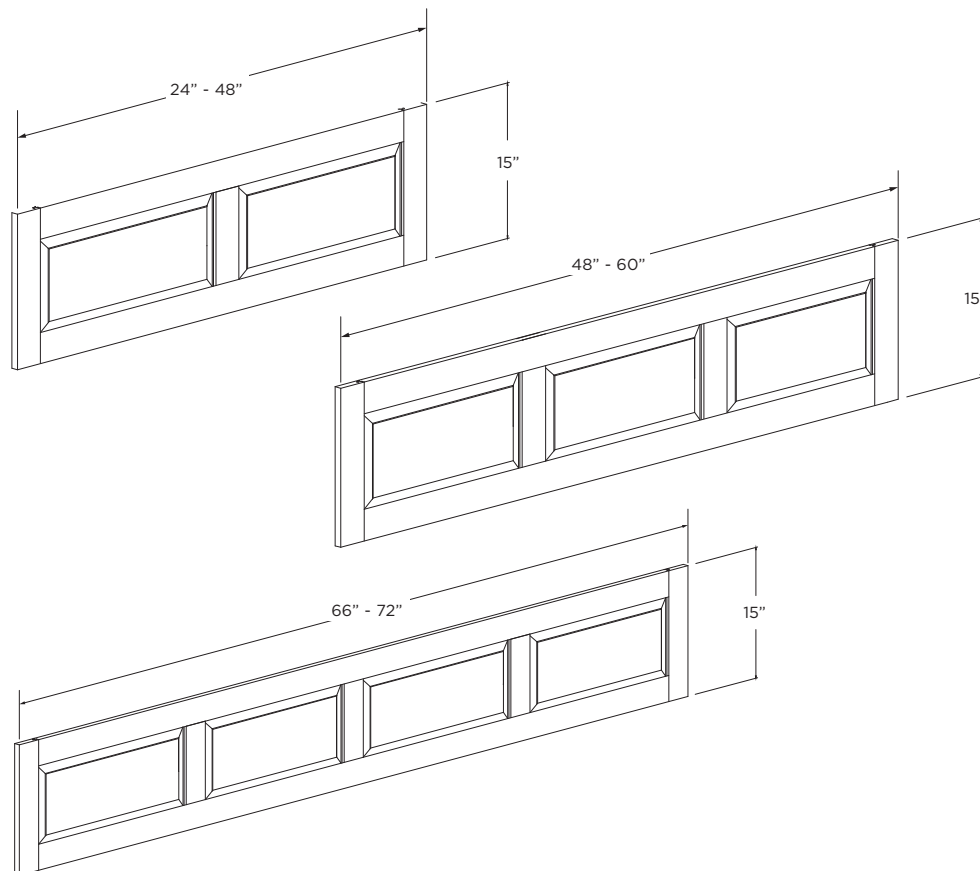

15" HIGH	PRICE
SQPV2415	631
SQPV2715	718
SQPV3015	807
SQPV3315	892
SQPV3615	982
SQPV3915	1068
SQPV4215	1155
SQPV4515	1243
SQPV4815	1330

15" HIGH	PRICE
SQPV4815-3	1330
SQPV6015-3	1720

15" HIGH	PRICE
SQPV6615-4	1751
SQPV7215-4	2258

## TOEKICK VALANCES

- Available with OG, OR, OS or SR profile on top edge.
- Specify profile. Valance to be mitered on job site. (Shipped with extra length for mitering.)
- 4-1/2"H

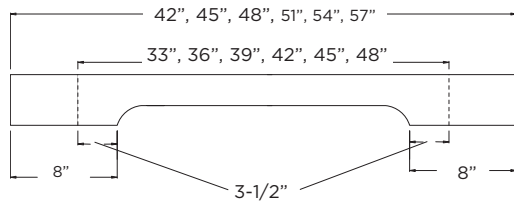

ARCHED	PRICE
ATKV33	166
ATKV36	
ATKV39	
ATKV42	
ATKV45	182
ATKV48	

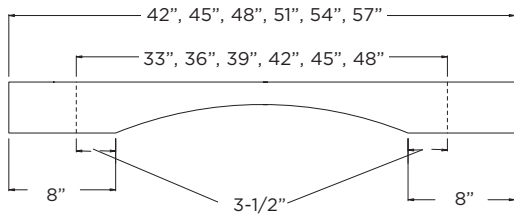

MISSION	PRICE
MTKV33	166
MTKV36	
MTKV39	
MTKV42	
MTKV45	182
MTKV48	

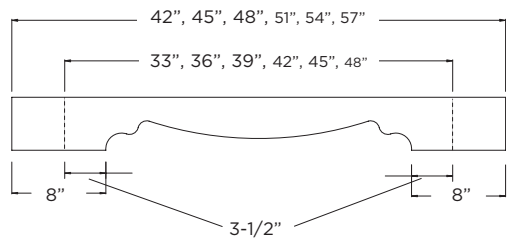

TRADITIONAL	PRICE
TTKV33	166
TTKV36	
TTKV39	
TTKV42	
TTKV45	182
TTKV48	

## VALANCES

- Bottom edge of valance is profiled to match the door profile. Doors with no profile will have SR profile on valance.

### ARCHED VALANCE



4-1/2"H	PRICE	6"H	PRICE
AV37-4	142	AV37-6	177
AV43-4	149	AV43-6	187
AV49-4	158	AV49-6	198
AV55-4	169	AV55-6	214
AV61-4	177	AV61-6	230
AV67-4	188	AV67-6	238
AV73-4	197	AV73-6	253
AV84-4	216	AV84-6	282

### STRAIGHT VALANCE

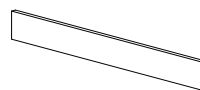

4-1/2"H	PRICE	6"H	PRICE
V37-4	86	V37-6	121
V43-4	94	V43-6	132
V49-4	103	V49-6	143
V55-4	112	V55-6	158
V61-4	123	V61-6	174
V73-4	142	V73-6	198
V84-4	165	V84-6	231

### MISSION VALANCE



4-1/2"H	PRICE	6"H	PRICE
MV37-4	142	MV37-6	177
MV43-4	149	MV43-6	187
MV49-4	158	MV49-6	198
MV55-4	165	MV55-6	210
MV61-4	177	MV61-6	230
MV67-4	188	MV67-6	238
MV73-4	197	MV73-6	253
MV84-4	216	MV84-6	282

### TRADITIONAL VALANCE



4-1/2"H	PRICE	6"H	PRICE
TV37-4	177	TV37-6	213
TV43-4	186	TV43-6	224
TV49-4	193	TV49-6	233
TV55-4	204	TV55-6	249
TV61-4	215	TV61-6	268
TV67-4	225	TV67-6	275
TV73-4	233	TV73-6	290
TV84-4	254	TV84-6	320

# MOLDINGS/MISCELLANEOUS

## WOOD TOPS

- All Wood Tops Must Be Securely Fastened To The Supporting Surface To Avoid Warping Or Twisting Of The Wood Top.
- Rustic Wood Species, Not Available

### VENEER

- 3/4" Thick, Veneered In Species Indicated.
- 1-1/2" CET Applied On Edges (Specify Front, Back, Left or Right)
- Specify CET Profile, See Page 1300-2
- Specify Width (Maximum 96")
- Specify Depth (Maximum 48")

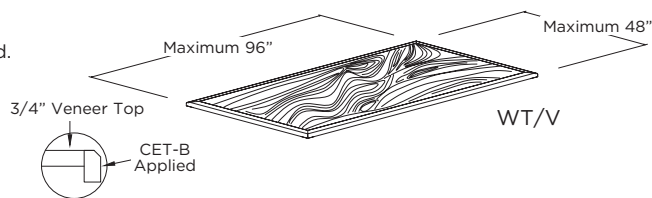

ITEM	PRICE
Veneer	50/SQ. FT.

### SOLID

- 3/4" Thick, Solid Wood In Species Indicated.
- Specify Width (Maximum 96")
- Specify Depth (Maximum 25" Recommended)
- More Depth Can Lead To Excessive Movement
- As Material Expands And Contracts
- Specify Edge Profile (Front, Back, Left or Right) and Edges to be Profiled:

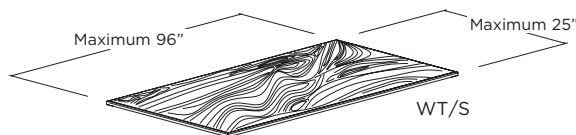

ITEM	PRICE
Solid	87/SQ. FT.

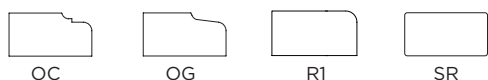

### BUTCHER BLOCK

- 1-1/2" or 3" Thick (Face Glued With Edges Exposed)
- Available in \*Maple, Oak, Cherry, Hickory or Birch
- Butcher Block Tops are unfinished
- Specify Width (Maximum 96")
- Specify Depth (Maximum 36") \*Depth for Maple Is 25"
- Specify Edge Profile (Front, Back, Left or Right) and Edges to be Profiled:

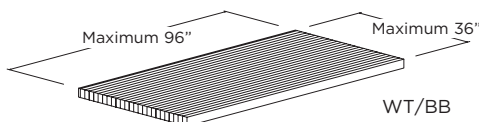

ITEM	PRICE
1-1/2" Thick	132/SQ. FT.
3" Thick	242/SQ. FT.



## SHELVING

### STANDARD SHELF

- Specify Cabinet Width and Depth
- 3/4" Thick Furniture Board
- Melamine Top, Bottom and Face Edge.
- Factory will Size Accordingly.

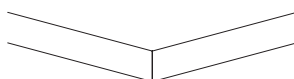

ITEM	PRICE
Standard	34/SQ. FT.

### FINISHED SHELF

- Specify Cabinet Width and Depth
- 3/4" Thick Plywood
- Wood Veneer Top, Bottom and Face Edge
- Custom Size: Specify Width and Depth

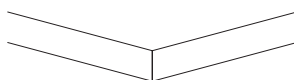

ITEM	PRICE
Finished	49/SQ. FT.

### GLASS SHELF

- Maximum Width 36" (With No Center Supports)
- Maximum Width 48" (With Center Supports Front And Back)
- 3/8" Clear Glass, Polished Edges.

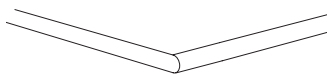

ITEM	PRICE
Replace STD Shelving	49/SQ. FT.
Separate Order	78/SQ. FT.

### WOOD FLOATING SHELF

- Includes Mounting Hardware
- Cut down depth and width at no charge. If depth is less than 10-1/2", steel bracket must be field cut.
- Mounting hardware must be attached to wall studs.
- Weight Capacity: 5 lbs/lineal foot
- Not Available in Laminates or Foils

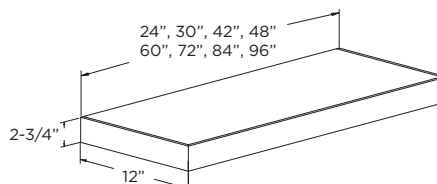

12" DEEP	PRICE
FS2412	390
FS3012	402
FS3612	416
FS4212	428
FS4812	451
FS6012	754
FS7212	781
FS8412	806
FS9612	852

**FURNITURE SHELF (LOOSE)**

- Two 3/4" thick plywood shelves, attached together with 1-1/2" thick solid stock on front and back edge.
- Finished top, bottom, front and back edges.
- SR profile on solid stock
- Matching wood and finish to cabinet exterior.
- Not Available in Laminates or Foils

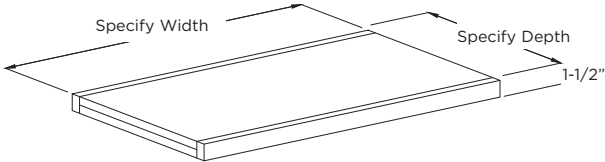

ITEM	PRICE
Shelf Only	49/SQ. FT. + 250 Per Shelf

**SHELF WITH RAIL (LOOSE)**

- 3/4" thick plywood shelf with 1-1/2" solid stock on front and back edges
- Finished top, bottom and solid stock rails.
- Matching wood and finish to cabinet exterior.
- Not Available in Laminates or Foils

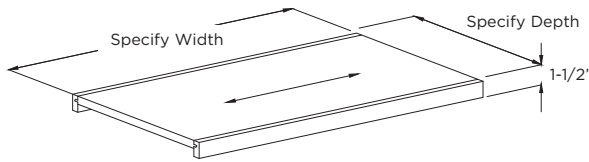

ITEM	PRICE
Shelf Only	49/SQ. FT. + 250 Per Shelf

# MOLDINGS/MISCELLANEOUS

## TURNED POSTS

- Available in all Standard Wood Species and Finishes
- All Turned Posts can be Trimmed
- Split Turned Posts are Sold in Sets of Two Only
- Please Specify Split Turned Post
- Please call factory for availability on custom sizes and/or styles of posts.

SMOOTH COLUMN



TOP VIEW

ITEM	PRICE
TPA03	476
TPA06	905
TPB03	476
TPB06	905
TPC03	476
TPC06	905
TPE03	476
TPE06	905
TPD03	476
TPD06	905
TPS03	476
TPS06	905
TPL03	234
TPL06	421
TPM03	264
TPM06	451
TPN03	264
TPN06	451
SPLIT TURN POST	ADD 114/SET

### TPA03

- (3" X 3" X 36")
- Can Trim up to 4" Each End

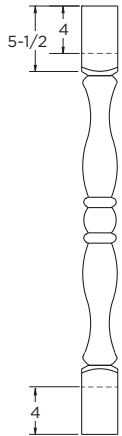

### TPA06

- (5" X 5" X 36")
- Can Trim up to 5" Each End

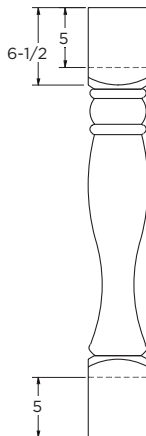

### TPC03

- (3" X 3" X 36")
- Can Trim up to 4" One End

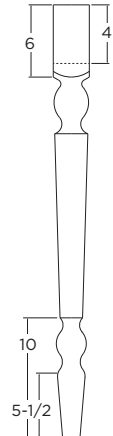

### TPC06

- (5" X 5" X 36")
- Can Trim up to 4" One End

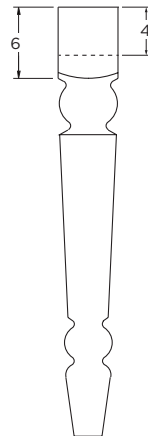

### TPE03

- (3" X 3" X 36")
- Can Trim up to 5" Each End

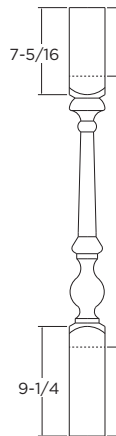

### TPE06

- (5" X 5" X 36")
- Can Trim up to 5" Each End

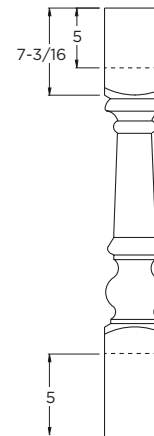

### TPB03

- (3" X 3" X 36")
- Can Trim up to 4" Each End

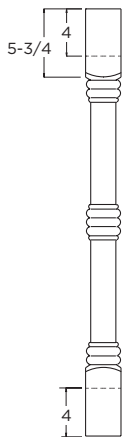

### TPB06

- (5" X 5" X 36")
- Can Trim up to 4" Each End

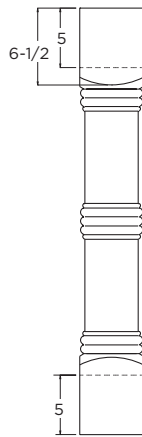

### TPD03

- (3" X 3" X 36")
- Can Trim up to 4" Each End

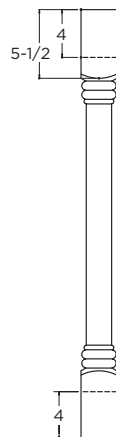

### TPD06

- (5" X 5" X 36")
- Can Trim up to 5" Each End

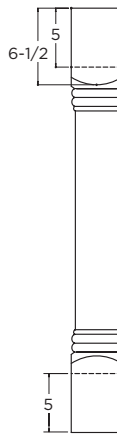

### TPS03

- (3" X 3" X 36")
- Can Trim up to 4" Each End

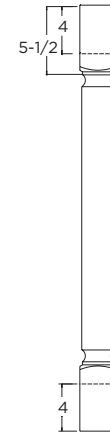

### TPS06

- (5" X 5" X 36")
- Can Trim up to 5" Each End

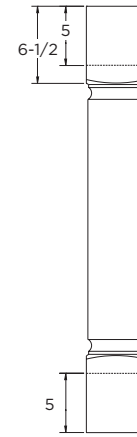

### TPL03

- (3" X 3" X 36")
- Can Trim, Specify



### TPL06

- (5" X 5" X 36")
- Can Trim, Specify



### TPM03

- (3" X 3" X 36")
- Can Trim on One End, Specify



### TPM06

- (5" X 5" X 36")
- Can Trim on One End, Specify



### TPN03

- (3" X 3" X 36")
- Can Trim up to 4" Each End

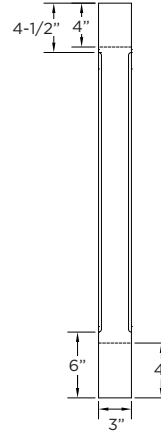

### TPN06

- (5" X 5" X 36")
- Can Trim up to 4" Each End

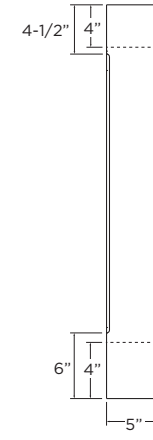



**ARCHITECTURAL POSTS**

• Specify Height

**3" WIDE**

AP3 (12-35)  
 AP3 (36-59)  
 AP3 (60-96)



**6" WIDE**

AP6 (12-35)  
 AP6 (36-59)  
 AP6 (60-96)



**WAINSCOT POST**

APW6 (12-35)  
 APW6 (36-59)  
 APW6 (60-96)

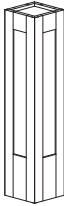

ITEM	PRICE
AP3 (12-35)	760
AP3 (36-59)	979
AP3 (60-96)	1265
AP6 (12-35)	1132
AP6 (36-59)	1469
AP6 (60-96)	1900
APW6 (12-35)	1189
APW6 (36-59)	1542
APW6 (60-96)	1995

# MOLDINGS/MISCELLANEOUS

## WOOD LEGS

- Available in all Standard Wood Species and finishes (except Rustic)
- All Wood legs are trimmable
- Split Wood Legs are sold in sets of two only
- Use split wood legs for toe space applications.
- Please specify split wood legs

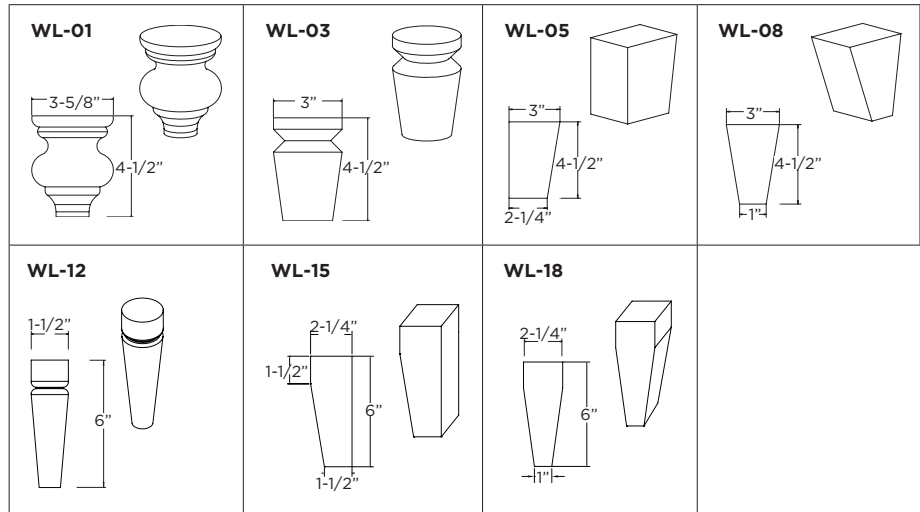

ITEM	PRICE
Wood Legs	117
Split Wood Legs	Add 114/SET
Attaching Leg to Cabinet	227/CABINET

## METAL LEGS

- All legs shipped loose.

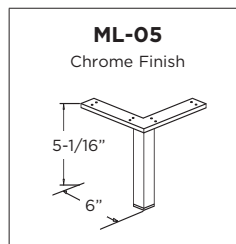

ITEM	PRICE
ML-05	95
Attaching Leg to Cabinet	227/Cabinet

## COUNTERTOP WOOD SUPPORT

- 1-1/4" X 8" X 8"
- Solid Wood

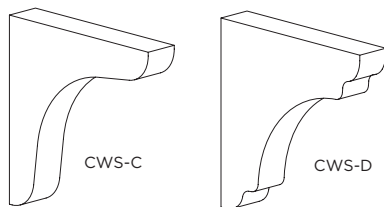

ITEM	PRICE
CWS-C	130
CWS-D	

## MCA68

- Carved Corbel

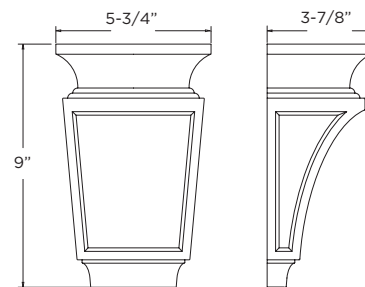

ITEM	WOOD SPECIES	PRICE
MCA68-C	Cherry	677
MCA68-M	Maple	534
MCA68-O	Oak	

## CASTERS (4) LOOSE

- Die Cast Metal Hooded Twin Wheel Caster with Nylon Wheels.
- 75 LB. Weight Capacity per caster.
- Wheel Size: 2"
- Overall Height: 2-5/8"
- Color: Black

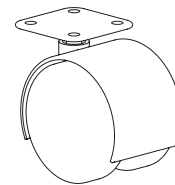

ITEM	PRICE
Casters (4)	509

FOIL MOULDINGS AVAILABLE IN GLOSS, MATTE, AND TEXTURED FOILS.

## FOIL, CEILING/LIGHT VALANCE MOLDING

- Straight FTMFOIL Molding is available for foil. Moldings are reversible for use as ceiling valance (top) or light valance (under-cabinet).
- Straight FTMFOIL molding is finished on both faces and edgebanded on one long edge.
- Grain runs the length of the molding when present.

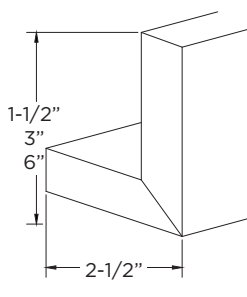
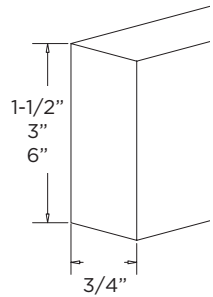
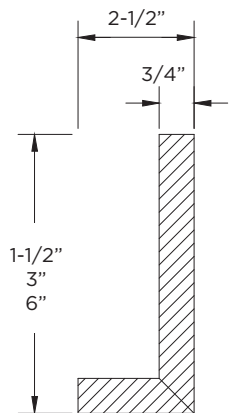
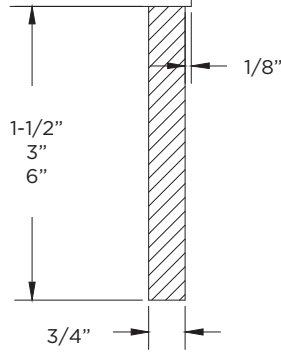
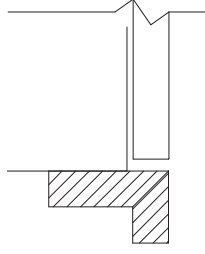
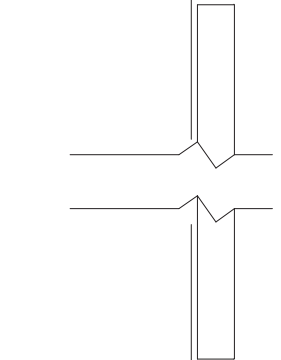
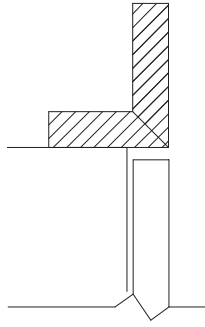
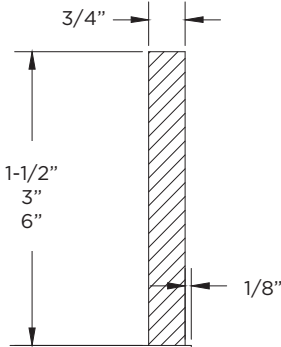

STRAIGHT	PRICE
FTMFOIL-96	208
FTM3FOIL-96	259
FTM6FOIL-96	414

L-SHAPED	PRICE
FTMLFOIL-96	518
FTML3FOIL-96	621
FTML6FOIL-96	725

## SCRIBE MOLDING

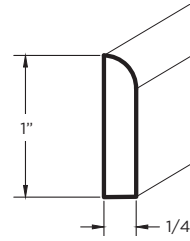

ITEM	PRICE
SMFOIL-96	195

## BATTEN MOLDING

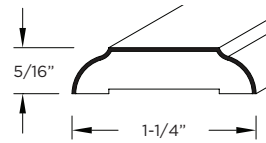

ITEM	PRICE
BMFOIL-96	195

## SHOE MOLDING

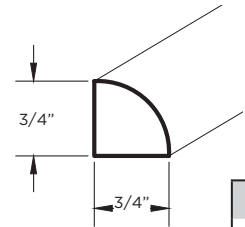

ITEM	PRICE
CBSFOIL-96	227

## OUTSIDE CORNER MOLDING

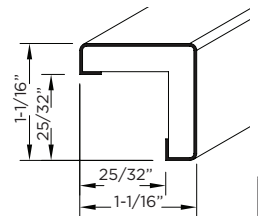

ITEM	PRICE
OSCFoil-96	259

## COVE CROWN

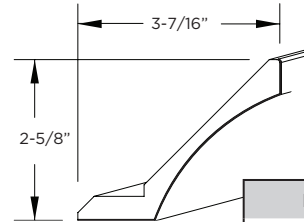

ITEM	PRICE
CR1215FOIL-96	342

## STRAIGHT CROWN

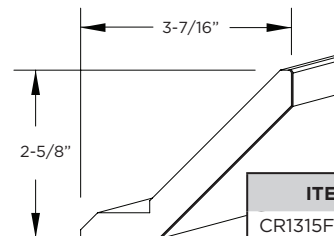

ITEM	PRICE
CR1315FOIL-96	342





**TABLE OF CONTENTS**

**FORMS ..... F1 THRU F20**

Marketing Order Form.....F3  
Molding Sample Order Form ..... F4  
Merchandiser Order Form.....F5  
Color Chip Order Form ..... F6  
Leaded Glass Order Form.....F7  
Appliance Specification Order Forms ..... F8 thru F10  
Job Site Delivery Form..... F11  
Product Awareness Statement ..... F12  
Dealer Product Awareness Form ..... F13  
Improvement Report Form..... F14  
Quote Form..... F15  
Standard Order Form..... F16 thru F17  
Job Completion Order Form..... F18  
Replacement Parts Order Form..... F19  
Custom Finish Match Form.....F20







**MAILING ADDRESS:** P.O. Box 2280, Waterloo, Iowa 50704  
**SHIPPING ADDRESS:** 4747 Crestwood Drive, Waterloo, Iowa 50702  
**P:** 319-268-2592 **F:** 1-800-973-1200 **E:** kitchen+@bertch.com

## KITCHEN+/ELAN MARKETING SUPPORT ORDER FORM

<b>DATE:</b>	<b>DEALER NAME:</b>	<b>ACCOUNT CODE:</b>	<b>DEALER PO#</b>	<b>JOB NAME:</b>
	<b>Bill To:</b>	<b>Sold To:</b>	<b>Ship To:</b>	
<b>NAME &amp; ADDRESS:</b>				
<b>PHONE:</b>				
<b>EMAIL:</b>				
<b>FAX:</b>				

CATALOGS/LITERATURE	QTY	LIST	QTY
Kitchen+ Literature - <i>KLT</i>	10	\$55	
Kitchen+ Catalog - <i>Binder, Tabs, Inserts</i>	1	\$120	
Kitchen+ Insert ONLY	1	\$57	
Kitchen+ Tabs ONLY	1	\$29	
Kitchen+ Binder ONLY	1	\$61	
Elan Catalog - <i>Binder, Tabs, Inserts</i>	1	\$120	
Elan Insert ONLY	1	\$57	
Elan Tabs ONLY	1	\$29	
Elan Binder ONLY	1	\$61	

SAMPLES	LIST	QTY
Glass Sample Set	\$40	
Color Chip Sample Kit (Box) - <i>142 Wood Samples, 8 Foil Samples</i>	\$1330	
Wooden Box Sample Holder	\$318	
Foil Chip Set - <i>8 Pieces</i>	\$128	
Molding Sample Set	\$600	
Distressing Menu Door	\$153	
<i>The following items have their own Order Form located in the Form Section of the catalog.</i>		
Kitchen+ Merchandiser Style B	\$9350	
Kitchen+ Merchandiser Style C	\$7500	
Molding Sample - <i>1 Piece</i>	\$11	
Wood Color Chip - <i>1 Piece</i>	\$16	
Foil Chip - <i>1 Piece</i>	\$16	

ITEM	LIST	QTY	DESCRIPTION
<b>Quick Response Sample Door</b>			
<i>Northbrook door style ONLY, 10"W x 15"H</i>			
<b>Standard Woods/Finishes</b>			
Standard Delivery UPS	\$90		
Second Day Delivery UPS	\$119		
Next Day Delivery UPS	\$169		
<b>Standard Woods/Glazes</b>			
Standard Delivery UPS	\$119		
Second Day Delivery UPS	\$143		
Next Day Delivery UPS	\$193		
<b>Drawer &amp; Door</b>			
<i>15"W x 26.5"H</i>			
Standard Woods/Finishes	\$200		
Foil/Laminate	\$200		
<b>Merchandiser Door</b>			
<i>13-7/8"W x 15"H</i>			
Standard Woods/Finishes/Glazes	\$153		
<b>Half Sample Door</b>			
Standard Woods/Finishes/Glazes	\$227		
Custom Color	\$886		
<b>Mini Base With Roll Tray</b>			
Standard Woods/Finishes	\$378		

## KITCHEN+/ELAN MOLDING SAMPLE ORDER FORM

DATE:	DEALER NAME:	ACCOUNT CODE:	DEALER PO#	JOB NAME:
	<b>Bill To:</b>	<b>Sold To:</b>	<b>Ship To:</b>	
<b>NAME &amp; ADDRESS:</b>				
<b>PHONE:</b>				
<b>EMAIL:</b>				
<b>FAX:</b>				

CHECK HERE TO ORDER ALL SAMPLES.

Molding pieces will be 4" in length, random wood species and finished in natural. Each piece will be \$11.00 list.  
 Check the individual molding pieces you need.

Batten Molding	BM	Crown Molding	CR1212
Chair Rail Molding - Contemporary 3/4"	CRM-C3/4	Crown Molding	CR1213
Chair Rail Molding - Traditional 3/4"	CRM-T3/4	Crown Molding	CR1011
Countertop Edge Trim - B	CET-B	Mirror Molding	MM
Countertop Edge Trim - OG	CET-OG	Moulded Light Rail	MLR
Countertop Edge Trim - SR	CET-SR	Molding Cleats and Spacers - 1/4"	MCS1/4
Corner Wing Molding	CWM	Molding Cleats and Spacers - 1/2"	MCS1/2
Crown Molding Angled	CR1313	Molding Cleats and Spacers - 3/4"	MCS3/4
Crown Molding Angled	CR1312	Outside Corner Molding	OSC
Crown Molding	CR1211	Outside Corner Molding Angled	OSCA
Crown Molding	CR1612	Outside Corner Molding	OSC-1
Crown Molding	CR1613	Outside Corner Molding	CBB012
Crown Molding Cove	CR1411	Plywood Trim Molding	PTM
Crown Molding Cove	CR1412	Quarter Round Molding	CBSO12
Crown Molding Cove	CR1413	Shoe Molding	CBSO11
Deluxe Cove Molding	DCM	Scribe Molding	SM
Flush Trim Molding	FTM	Small Crown Bevel	Y1M
Furniture Base Molding - OC	FBM-OC	Small Crown Cove	P1M
Furniture Base Molding - SR	FBM-SR	Small Crown Traditional	T1M
Furniture Base Molding - OD	FBM-OD	Square 4 Sides	S4S
Furniture Base Molding - OG	FBM-T	Square Light Rail	SLR
Inside Corner Molding	CBMO12	Tru-Bead Molding	TBM-3
Inside Corner Molding	CBMO11	Tru-Bead Molding	TBM-6
Mini Deluxe Cove Molding	MDCM		



## KITCHEN+/ELAN MERCHANDISER ORDER FORM

DATE:	DEALER NAME:	ACCOUNT CODE:	DEALER PO#	JOB NAME:
BILL TO:		SOLD TO:		SHIP TO:

CABINET SUGGESTIONS:				
STYLE B	WOOD	FINISH	GLAZE	SHEEN
EDGEWOOD	BIRCH	POLAR	--	MATTE
CHANGE TO:				
STYLE C	WOOD	FINISH	GLAZE	SHEEN
QUINCY	CHERRY	MINERAL	--	MATTE
CHANGE TO:				
QUINCY				

MERCHANDISER INCLUDES:
<p><b>STYLE B</b> - LIST PRICE: \$9,350</p> <ul style="list-style-type: none"> <li>• Overall Size: 64"W x 88"H x 25"D</li> <li>• Maximum Capacity 48 Doors</li> <li>• Your choice of cabinet door style, wood, finish, glaze, and sheen.</li> </ul> <p><b>STYLE C</b> - LIST PRICE: \$7,500</p> <ul style="list-style-type: none"> <li>• Overall Size: 30"W x 90"H x 21"D</li> <li>• Maximum Capacity 45 Doors</li> <li>• Your choice of wood, finish, glaze, and sheen.</li> </ul> <ul style="list-style-type: none"> <li>• <b>35 Merchandiser Doors Included</b> (option to change style, wood, finish)</li> <li>• <b>1 Color Chip Set (150)</b></li> <li>• <b>Glass Sample Set</b></li> <li>• <b>Molding Sample Set</b></li> </ul>

DOOR SAMPLE SUGGESTIONS:					CHANGE TO:				
STYLE	WOOD	FINISH	GLAZE	SHEEN	STYLE	WOOD	FINISH	GLAZE	SHEEN
ASHTON	PAINT	INDIGO	--	MATTE					
BECKETT	BIRCH	FLAGSTONE	--	S. GLOSS					
BRISTOL	ALDER	KODIAK	--	MATTE					
CLARKSON	PAINT	GROVE	--	MATTE					
CRAFTWOOD	BIRCH	DAWN	BRUSHED BLACK	MATTE					
DAWSON	BIRCH	SPRUCE	--	MATTE					
DELANEY	HICKORY	MINERAL	--	S. GLOSS					
DISTRICT	PAINT	GRAPHITE	--	MATTE					
EDGEWOOD	WALNUT	NATURAL	--	MATTE					
EMERSON	PAINT	DUNE	--	MATTE					
HUNTINGTON	PAINT	POLAR	FULL GRAY	MATTE					
HUTTON	PAINT	HARBOR	--	MATTE					
LEXINGTON	CHERRY	SHALE	--	MATTE					
LEXINGTON 3	QSRO	DRIFTWOOD	--	MATTE					
MARCUS	WALNUT	DRIFTWOOD	--	MATTE					
MONTEREY	PAINT	CLOUD	--	MATTE					
NORTHBROOK	BIRCH	INKWELL	--	MATTE					
ODESSA	MAPLE	SNOWBANK	--	MATTE					
PORTLAND	PAINT	BLACK	--	MATTE					
QUINCY	PAINT	WHITE	--	MATTE					
RIVERSIDE	WALNUT	DAWN	--	MATTE					
SAWYER	PAINT	POLAR	--	MATTE					
SEVILLE	PAINT	OLIVE	--	MATTE					
SONOMA	MAPLE	LODGE	--	MATTE					
VENICE	ALDER	MOCHA	--	MATTE					
VERONA	MAPLE	CHINCHILLA	--	S. GLOSS					
VERONA 3	CHERRY	RIVER ROCK	--	MATTE					
VILLAGER	PAINT	COBALT	--	MATTE					
WICKER PARK	PAINT	SNOWFLAKE	--	MATTE					
WILLIAMSBURG	CHERRY	TOFFEE	--	S. GLOSS					
WINSTON	BIRCH	SHORELINE	--	MATTE					
WOODBIDGE	RUSTIC HICKORY	CHALET	--	MATTE					
JOSS	FOIL	GIBRALTAR	--	--					
RIDLEY	FOIL	WHITE MATTE	--	--					
SULLIVAN	FOIL	MIDNIGHT MATTE	--	--					

## KITCHEN+/ELAN STANDARD WOOD COLOR CHIP ORDER FORM

DEALER NAME	ACCOUNT CODE	DEALER PO NO.	JOB NAME
-------------	--------------	---------------	----------

WHEN ORDERING A GLAZE FINISH, PLEASE SPECIFY GLAZE APPLICATION. ■ NOT AVAILABLE • INCLUDED IN SAMPLE CHIP SET

Finishes		Alder Select Alder Rustic Alder \$16				Birch \$16				Cherry \$16				Hickory Rustic Hickory \$16				Maple \$16				Oak 1/4 Sawn Red Oak \$16				Walnut \$21			
		GLAZE				GLAZE				GLAZE				GLAZE				GLAZE				GLAZE							
		STANDARD	BLACK	BROWN	GREY	STANDARD	BLACK	BROWN	GREY	STANDARD	BLACK	BROWN	GREY	STANDARD	BLACK	BROWN	GREY	STANDARD	BLACK	BROWN	GREY	STANDARD	BLACK	BROWN	GREY	STANDARD	BLACK	BROWN	GREY
STAINS	BRINDLE				•				•																				
	CANYON	•							•				•								•				•				
	CHALET	•							•				•								•				•				
	CHINCHILLA					•			•				•								•				•				
	COFFEE BEAN					•			•				•								•				•				
	DAWN	•				•	•		•				•								•				•				
	DRIFTWOOD	•				•			•				•								•				•				
	FLAGSTONE	•				•			•				•								•				•				
	HARVEST	•				•			•				•								•				•				
	HONEY	•				•			•				•								•				•				
	INKWELL					•			•				•								•				•				
	KODIAK	•				•			•				•								•				•				
	KONA					•			•				•								•				•				
	LODGE	•				•			•				•								•				•				
	MINERAL	•				•			•				•								•				•				
	MOCHA	•				•			•				•								•				•				
	NATURAL	•				•			•				•								•				•				
	RIVER ROCK	•				•			•				•								•				•				
	SHALE	•				•			•				•								•				•				
	SHORELINE	•				•			•				•								•				•				
SNOWBANK	•				•			•				•								•				•					
TOFFEE	•				•	•		•				•								•				•					
SOLIDS	BLACK				•																								
	CLOUD				•																								
	COBALT				•																								
	DUNE				•																								
	EGGSHELL				•																								
	GRAPHITE				•																								
	GROVE				•																								
	HARBOR				•																								
	INDIGO				•																								
	LIGHTHOUSE				•																								
	LOFT				•																								
	OLIVE				•																								
	OYSTER BAY				•																								
	POLAR				•	•	•	•																					
	SAGE				•																								
	SAILCLOTH				•																								
	SMOKE				•																								
	SNOWFLAKE				•																								
SPRUCE				•																									
WHITE				•																									

### LEAD GLASS ORDER FORM

DATE:	DEALER NAME:	ACCOUNT CODE:	DEALER PO#	JOB NAME:
<b>NAME &amp; ADDRESS:</b>	<b>Bill To:</b>	<b>Sold To:</b>	<b>Ship To:</b>	
PHONE:				
EMAIL:				
FAX:				

Indicate on the drawing the textures (by number) of glass you want for each glass piece in the style.

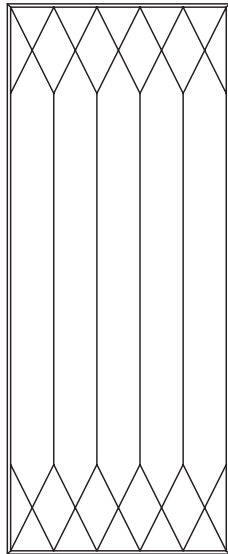

**DIAMOND**  
Style "A"

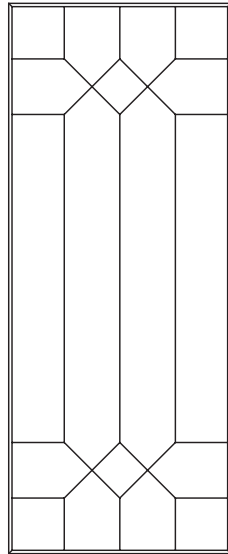

**TRADITIONAL**  
Style "B"

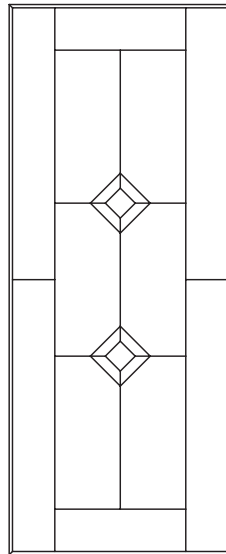

**DOUBLE CLEAR BEVEL**  
Style "C"

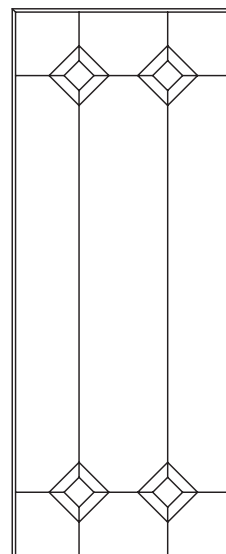

**QUADRANT CLEAR BEVEL**  
Style "D"

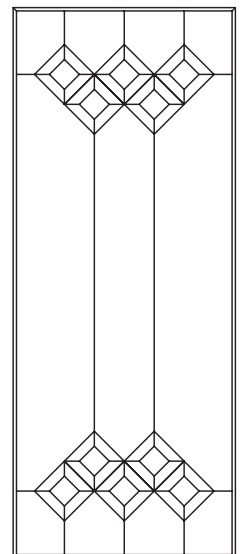

**CLEAR BEVEL CLUSTERS**  
Style "E"

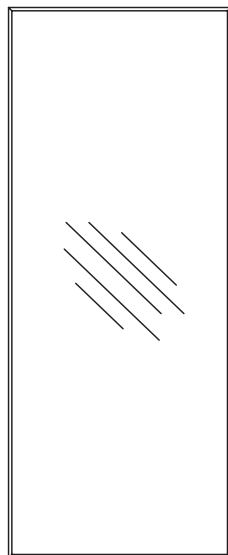

**CLEAR WITH TEXTURE**  
Style "G1"

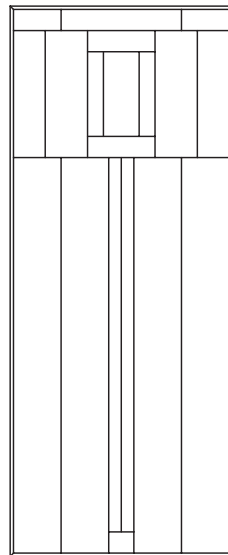

**CONTEMPORARY**  
Style "H"

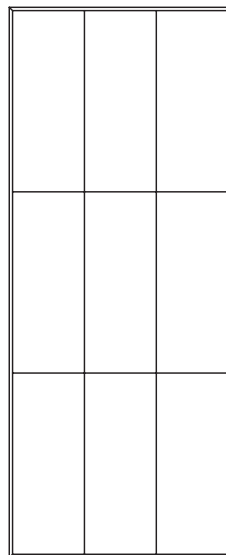

**WINDOWPANE**  
Style "K"

## APPLIANCE SPECIFICATION ORDER FORM

Order Date	COMPANY NAME	DEALER PO NO.	JOB NAME
------------	--------------	---------------	----------



**STYLE "A"**  
 APA  
 1/4" Flat Panel  
 Specify Panel  
 Sizes

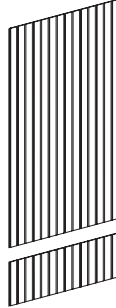

**STYLE "B"**  
 APB  
 1/4" Grooved Flat Panel  
 Specify Panel Sizes

<b>STYLE "A" OR "B"</b>	<b>1/4" PLYWOOD PANEL</b>
-------------------------	---------------------------

Style _____	<b>WIDTH</b>	<b>HEIGHT</b>
<b>Panel #1</b>	_____	_____
<b>Panel #2</b>	_____	_____

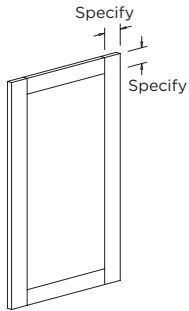

**STYLE "D"**  
 APD  
 Door Frame Only  
 Center Area Open  
 Specify Width and Height of  
 Door Frame  
 Specify Rail & Stile Width

<b>STYLE "D"</b>	<b>3/4" DOOR FRAME WITH CENTER OPEN</b>
------------------	---

	<b>WIDTH</b>	<b>HEIGHT</b>
<b>Door #1</b>	_____	_____
<b>Rail &amp; Stile</b>	_____	_____

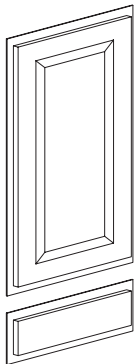

**STYLE "E"**  
 APE  
 Deluxe Door Style Panel  
 With Custom Reveals  
 Specify Width and Height  
 of 1/4" Panel and 3/4" Deluxe  
 Door Style Panel (s)

To be Field Applied  
Shipped Separate

<b>STYLE "E"</b>	<b>1/4" PLYWOOD PANEL &amp; DELUXE DOOR STYLE PANEL</b>
------------------	---

	<b>WIDTH</b>	<b>HEIGHT</b>
<b>Panel #1</b>	_____	_____
<b>Panel #2</b>	_____	_____
<b>Door #1</b>	_____	_____
<b>Door #2</b>	_____	_____

## APPLIANCE SPECIFICATION ORDER FORM

ORDER DATE	COMPANY NAME	JOB NAME	DEALER PO#
------------	--------------	----------	------------

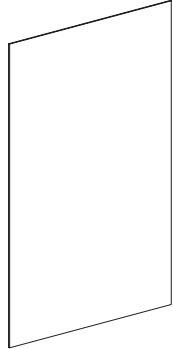

**Style "A"**  
 RDPA  
 1/4" Flat Panel  
 Specify Panel Sizes

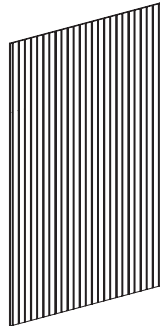

**Style "B"**  
 RDPB  
 1/4" Groove Flat Panel  
 Specify Panel Sizes

<b>STYLE "A" OR "B"</b>	<b>1/4" PLYWOOD PANEL</b>
-------------------------	---------------------------

Style _____	<b>WIDTH</b>	<b>HEIGHT</b>
<b>Panel #1</b>	_____	_____
<b>Panel #2</b>	_____	_____
<b>Panel #3</b>	_____	_____
<b>Panel #4</b>	_____	_____
<b>Panel #5</b>	_____	_____
<b>Panel #6</b>	_____	_____



**Style "D"**  
 RDPD  
 Door Frame Only  
 Center Area Open  
 Specify Width and Height of Door Frame  
 Specify Rail and Stile Width

<b>STYLE "D"</b>	<b>3/4" DOOR FRAME WITH CENTER OPEN</b>
------------------	---

	<b>WIDTH</b>	<b>HEIGHT</b>
<b>Door #1</b>	_____	_____
<b>Rail &amp; Stile</b>	_____	_____

## APPLIANCE SPECIFICATION ORDER FORM

Order Date	COMPANY NAME	DEALER PO NO.	JOB NAME
------------	--------------	---------------	----------

### STYLE "E"

RDPE  
 Deluxe Door Style Panel With Custom Reveals  
 Specify Width and Height of 1/4" Panel, 3/4" Deluxe Door Style Panel (s), and Option 1, 2, 3, or 4

To be Field Applied  
 Shipped Separate

### Mortise & Tenon Door Style Parameters

Doors up to 26" wide default to a single panel door.  
 Doors over 26" wide and larger default to a horizontal double panel door.

Doors up to 48" high default to a single panel door.  
 Doors over 48" high and larger default to a vertical double panel door.

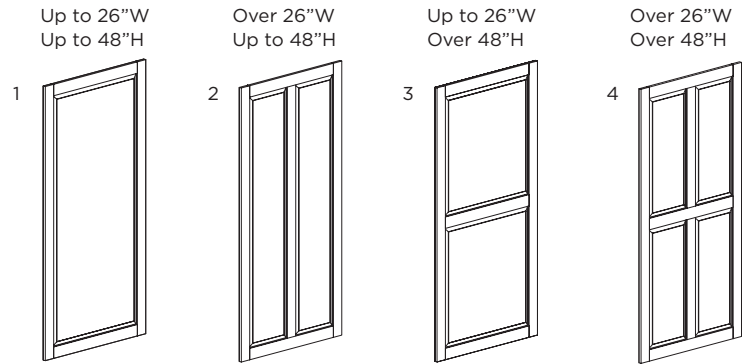

### Mitered Door Style Parameters

Doors up to 26" wide default to a single panel door.  
 Doors over 26" wide and larger default to horizontal double doors.

Doors up to 48" high default to a single panel door.  
 Doors over 48" high and larger default to vertical double doors.

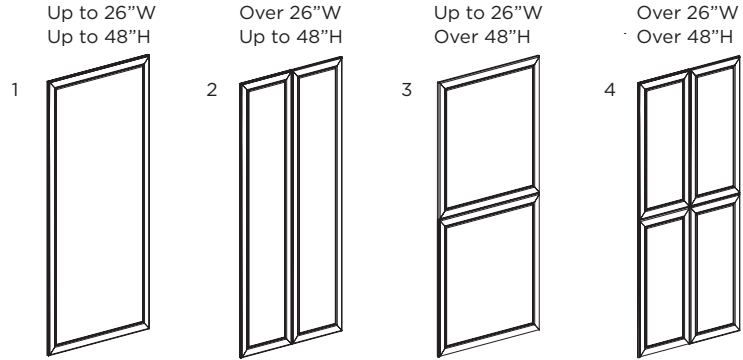

<b>STYLE "E"</b>	<b>1/4" PLYWOOD PANEL</b>	
------------------	---------------------------	--

	WIDTH	HEIGHT
Panel #1	_____	_____
Panel #2	_____	_____
Panel #3	_____	_____
Panel #4	_____	_____
Panel #5	_____	_____
Panel #6	_____	_____

<b>DELUXE DOOR STYLE PANEL</b>				
--------------------------------	--	--	--	--

	DOOR OR DRAWER FRONT	WIDTH	HEIGHT	OPTION
Door #1	_____	_____	_____	_____
Door #2	_____	_____	_____	_____
Door #3	_____	_____	_____	_____
Door #4	_____	_____	_____	_____
Door #5	_____	_____	_____	_____
Door #6	_____	_____	_____	_____

## JOB SITE DELIVERY FORM

**PLEASE FAX COMPLETED FORM TO 1-800-973-1200.  
 IF JOB SITE DELIVERY FORM IS NOT COMPLETE, THE DELIVERY WILL GO TO THE DEALER'S LOCATION.**

BATH     MARKETPLACE     KITCHEN+

DEALER NAME		DEALER CONTACT	
BUSINESS HOURS		BUSINESS PHONE	BUSINESS CELL PHONE
JOB NAME		JOB SITE CONTACT	
JOB SITE PHONE#	JOB SITE CELL PHONE	JOB SITE ADDRESS (STREET, CITY, STATE)	

Please include your job site delivery form with your order. The form must be complete including written directions and signature. If the form is not complete the delivery will go to the Dealer's location. The Dealer will be notified by an acknowledgement as to which week to expect delivery. Bertch drivers will call the Dealer direct a minimum of 24 hours prior to delivery. Type or print specific directions below from the nearest major highway. If you need more room continue on the back of this form.  
**WRITTEN DIRECTIONS MUST ACCOMPANY ORDER.**

---



---



---



---

**JOBSITE DELIVERY FEE \$950 LIST**

**DEALER RESPONSIBILITY CHECK LIST - ITEMS MUST BE CHECKED-OFF**

- Physically check the job site for accessibility of a 68' Semi Tractor-Trailer. Our trailers require a height clearance of 13'6". (This includes power lines, low tree branches, low overpasses, bridge or road weight or width limits). There must be ample space to turn around (NO CUL-DE-SACS, hairpin curves or extreme grades). We will not travel on dirt/gravel roads. Check for any other obstructions that will cause an accessibility problem.
- Two able-bodied people must be at the job site location to help unload the products from the trailer to the residence. Our drivers will be responsible for tailgating the products and assisting the Dealer Staff when necessary to unload large/heavy items.
- Upon Bertch/S.C.B. drivers 24 hour notification of delivery the dealer must make the necessary arrangements with the customer for a timely delivery. If contact cannot be made we reserve the right to return the products to Bertch and reschedule them on our next available truck. Dealer will accept additional charges if driver is not met as agreed and needs to reschedule.
- Any materials damaged during delivery on our trucks, requiring factory repair or replacement must be noted immediately and returned on the same truck.
- Upon driver inspection of the actual job site the driver may refuse to make the delivery at the job site if he feels it is unsafe or unmanageable with the consent of Bertch Cabinet, LLC./S.C.B. Fines or charges incurred as a result of a job site delivery will be paid by the Dealer (this includes any towing charges, repairs to low power lines, overweight/over-width restriction fines, damages to property or equipment).

**If the above criteria is not met when driver arrives, future job site deliveries to Dealer location will be denied.  
 The undersigned understands his/her responsibility and acknowledges the conditions of this application.**

DEALER SIGNATURE \_\_\_\_\_ DATE \_\_\_\_\_

DEALER NAME (PLEASE PRINT) \_\_\_\_\_

## PRODUCT AWARENESS STATEMENT

DEALER NAME	ACCOUNT CODE	DEALER PO NO.	JOB NAME
-------------	--------------	---------------	----------

**As the purchaser of this product, we want you to be fully informed of the characteristics below. We cannot produce the product without these characteristics, therefore it is important that you find them acceptable.**

<p><b>SOLID COLOR FINISHES</b></p> <p><b>TELEGRAPHING</b> The solid finishes are applied to a solid wood face frame. Oak is an open or coarse grain wood. The grain will “telegraph” or show visibly throughout the finish. Birch is a close or fine grain wood. Some “telegraphing” will occur, though the effect will be subtle.</p> <p><b>JOINT FRACTURE</b> Because wood is a product which is in a constant state of expansion and contraction, hairline fractures will very soon be noticeable at the joints on the cabinet face frame and doors. These will not weaken the finish, but they will be visible.</p> <p><b>MITER DOORS</b> When mitered doors are painted with a solid color finish, the joints of the miter door will appear as the wood expands and contracts due to normal environmental changes.</p>	<p><b>GLAZING</b> Glaze is a transparent finish material applied over the sealer which tones the overall appearance and highlights profiles and recessed areas creating an “antique” or “aged” look. This additional finishing step emphasizes joints, character marks and grain areas. A protective topcoat is applied over the glaze, which adds depth to the finish. Natural variations will be apparent on individual parts and within Jobs.</p> <p><b>SHRINKING AND SWELLING</b> Shrinking and swelling occur as wood changes moisture content in response to daily (as well as seasonal) changes in the relative humidity of the environment to which the wood is exposed. When the air is humid, wood absorbs moisture and swells; when the air is dry, wood loses moisture and shrinks. This is a fundamental law of nature and is NOT a defect in materials or workmanship by Bertch Cabinet, LLC. Doors that swell and rub; center panels of doors that shrink and expose pre-stained areas; and miters that either open to the outside or widen on the inside at the joint are all examples of wood movement due to the consumer’s environment. These effects should be minimized by maintaining a moisture content in the home (or, where the cabinets are stored) between 30 and 40% relative humidity (temperature between 50 and 80 degrees F).</p>	<p><b>WOOD VARIATIONS</b> Some trees vary in color shades of white, pink, green, gray, and black. Some have even grain patterns; others can be quite wild. Some have worm tracks and pitch marks and mineral streaks. Some absorb stain readily; others practically refuse to absorb. Some tend to get darker and some considerably darker (especially Cherry) as time passes.</p> <p>Most combinations of woods and finishes are seen commonly, thus the final look is no surprise. There are a few combinations which are rarely enough seen that most people may be surprised by the aforementioned combination of independent characteristics and their effect on the visual appearance of the final wood product. Please see the Product Awareness Matrix for information on wood/color combinations that should be explained to your customer.</p> <p><b>VENEER DOORS</b> The grain pattern will not always flow throughout the kitchen depending on the layout and length of the run of cabinets. Some species and cuts will be less noticeable than others. Rift cut for example, tends to be a pretty straight grain, so differences in one piece of veneer to the next are much less noticeable. Flat cuts - like walnut tend to have much more variation in the flow and appearance of the grain.</p>	<p><b>RUSTIC WOODS</b> All natural characteristics of Rustic Woods may be represented in this product which include the following character marks: Solid wood will have character marks such as large knots and wane. Other characteristics include: small pin knots, bird pecks, worm tracks, mineral stain, irregular figures in the grain, cracks that do not hurt the strength of the part, sap wood and cherry pitch marks. Cabinet face frames, plywood returns, Tri Views, Oval Mirror and Medicine Cabinet, Wood Tops, Frieze Valances, Wood Hoods (plywood components, scribe and outside corner moulding) will not be rustic.</p> <p>Available Mouldings: CM, MCM, PR, FBM-T, FBM-C</p> <p>Not available with solid color finishes due to the nature of open knots not accepting solid color finishes.</p> <p><b>CLEANING CABINETRY</b> Information on cleaning your cabinets is located on the Bertch website.</p> <p><a href="https://www.bertch.com/support/cleaning-care/">https://www.bertch.com/support/cleaning-care/</a></p>
---	--	--	--

**The undersigned understands their responsibility and acknowledge the conditions of this declaration and will not hold Bertch responsible for these natural characteristics.**

DEALER SIGNATURE \_\_\_\_\_ DATE \_\_\_\_\_

DEALER NAME (PLEASE PRINT) \_\_\_\_\_

CUSTOMER SIGNATURE \_\_\_\_\_ DATE \_\_\_\_\_

CUSTOMER NAME (PLEASE PRINT) \_\_\_\_\_



---

## DEALER PRODUCT AWARENESS AGREEMENT

---

As an authorized dealer of Bertch products the undersigned (representing the dealership) acknowledges the responsibility of explaining, and educating each of our (Bertch) customers in the specific characteristics inherent to the various wood species, wood traits (to include rustic and knotty as well as distressing) and unique finishes available through Bertch Cabinet, LLC. The undersigned understands that as new finishes, traits and wood species become available it is their responsibility to present these new characteristics for these items, as well as any current items available from Bertch.

The undersigned agrees not to hold Bertch Cabinet, LLC. responsible if a customer has not been made aware of the unique characteristics of the properties of their specific project, if those characteristics are within the standards established by Bertch Cabinet, LLC.

The undersigned must be either an Officer or Principal of the dealership. The undersigned understands their responsibility and acknowledges the conditions of this declaration, and will not hold Bertch Cabinet, LLC. responsible for these characteristics.

**DEALERSHIP** \_\_\_\_\_ **DATE** \_\_\_\_\_

**LOCATION** \_\_\_\_\_

**OFFICER OR PRINCIPAL'S SIGNATURE** \_\_\_\_\_

**PLEASE PRINT ABOVE NAME** \_\_\_\_\_

THE ABOVE SIGNED DEALER PRODUCT AWARENESS STATEMENT ALLOWS BERTCH TO PROCESS ORDERS WITHOUT AN INDIVIDUAL CUSTOMER SIGNED PRODUCT AWARENESS DECLARATION FORM WITH EACH PERTINENT ORDER.



**MAILING ADDRESS:** P.O. Box 2280, Waterloo, Iowa 50704  
**SHIPPING ADDRESS:** 4747 Crestwood Drive, Waterloo, Iowa 50702  
**P:** 319-268-2592 **F:** 1-800-973-1200 **E:** kitchen+@bertch.com

### IMPROVEMENT REPORT

Date: \_\_\_\_\_ Dealer Name: \_\_\_\_\_  
 Job Name: \_\_\_\_\_ Salesman: \_\_\_\_\_  
 Complaint: \_\_\_\_\_ Compliment: \_\_\_\_\_ Suggestion: \_\_\_\_\_

**REASON:**

_____ Acknowledgement	_____ Cabinets	_____ Quality _____
_____ Doors	_____ Shipping UPS, RPS or SCB	_____ Drawer Fronts
_____ Order Processing	_____ Wood	_____ Phone Call Not Returned
_____ Stain	_____ Product	_____ Pricing
_____ Service	_____ Other	

**COMMENTS:** \_\_\_\_\_

INTERNAL USE ONLY			
ORIGINAL BCM#	PW:	SEQ#	LINE#
JOB NAME:	NEW BCM#	DEALER REP:	



**MAILING ADDRESS:** P.O. Box 2280, Waterloo, Iowa 50704  
**SHIPPING ADDRESS:** 4747 Crestwood Drive, Waterloo, Iowa 50702  
**P:** 319-268-2592 **F:** 1-800-973-1200 **E:** kitchen+@bertch.com

### IMPROVEMENT REPORT

Date: \_\_\_\_\_ Dealer Name: \_\_\_\_\_  
 Job Name: \_\_\_\_\_ Salesman: \_\_\_\_\_  
 Complaint: \_\_\_\_\_ Compliment: \_\_\_\_\_ Suggestion: \_\_\_\_\_

**REASON:**

_____ Acknowledgement	_____ Cabinets	_____ Quality _____
_____ Doors	_____ Shipping UPS, RPS or SCB	_____ Drawer Fronts
_____ Order Processing	_____ Wood	_____ Phone Call Not Returned
_____ Stain	_____ Product	_____ Pricing
_____ Service	_____ Other	

**COMMENTS:** \_\_\_\_\_

INTERNAL USE ONLY			
ORIGINAL BCM#	PW:	SEQ#	LINE#
JOB NAME:	NEW BCM#	DEALER REP:	



**MAILING ADDRESS:** P.O. Box 2280, Waterloo, Iowa 50704  
**SHIPPING ADDRESS:** 4747 Crestwood Drive, Waterloo, Iowa 50702  
**P:** 319-268-2592    **F:** 1-800-973-1200    **E:** kitchen+@bertch.com

### QUOTE FORM

<b>DATE:</b>	<b>PHONE:</b>	<b>FAX:</b>	<b>FROM:</b>
<b>DEALER NAME:</b>	<b>ACCT. CODE:</b>	<b>JOB NAME:</b>	<b>DOOR STYLE:</b>

**ADDITIONAL INFORMATION:**

**SKETCH:**



MAILING ADDRESS: P.O. Box 2280, Waterloo, Iowa 50704  
 SHIPPING ADDRESS: 4747 Crestwood Drive, Waterloo, Iowa 50702  
 P: 319-268-2592 F: 1-800-973-1200 E: kitchen+@bertch.com

Kitchen+  Elan

### ORDER FORM

BCM Order#:	Acct#	Order Date:	Job Name:	Ship VIA:	
Order Type:		Est Ship Date:	Dealer PO#:	Sold By:	# of Pages:
Name & Address:		Bill To:	Sold To:	Ship To:	
Phone:					
Email:					
Fax:					

DELIVERY OF LESS THAN SIX CABINETS WILL HAVE A \$180.00 LIST DROP CHARGE.

DOOR	UPPER	LOWER	DRAWER
Style:			<input type="checkbox"/> Slab
Profile/Panel:			<input type="checkbox"/> 5-Piece
Material/Species:			
Finish:			

BOX		FINISH	
Style Series:		Finish:	
Material/Species:		Sheen:	
Construction:	<input type="checkbox"/> Standard <input type="checkbox"/> All Plywood	Finish Traits:	
Wood Traits:		Glaze Color:	
		Glaze Application:	

FRAMED	CASEWORK	ELAN	FRAMED	DRAWER BOX/ GLIDE	ELAN
<input type="checkbox"/> Standard (Birch Natural Laminate)	<input type="checkbox"/> Birch Natural Laminate (Standard Option)		<input type="checkbox"/> Dovetail Softmotion (Default)	<input type="checkbox"/> Dovetail Softmotion (Default)	
<input type="checkbox"/> All Plywood (Birch Veneer)	<input type="checkbox"/> White Laminate (Standard Option)			<input type="checkbox"/> Tandem	
	<input type="checkbox"/> All Plywood (Birch Veneer)				

#### SPECIAL INSTRUCTIONS



**MAILING ADDRESS:** P.O. Box 2280, Waterloo, Iowa 50704  
**SHIPPING ADDRESS:** 4747 Crestwood Drive, Waterloo, Iowa 50702  
**P:** 319-268-2592   **F:** 1-800-973-1200   **E:** kitchen+@bertch.com

Kitchen+    Elan

## ORDER FORM

BCM Order#:	Acct#	Order Date:	Job Name:	Ship VIA:	
Order Type:		Est Ship Date:	Dealer PO#:	Sold By:	# of Pages:

ITEM#	ITEM	QTY	HINGE	FINISH ENDS	ITEMIZED INSTRUCTIONS	UNIT PRICE	EXTENSION

## JOB COMPLETION ORDER FORM

Reference Original Order # \_\_\_\_\_

Kitchen+  Elan

**LEVEL 1** -- Completed in 9-13 Calender Days and Ships UPS or on Next Available SCB Truck if too large to ship UPS, Unless Commercial Carrier Arrangements are Made at Dealers' Expense. Items available: All Standard Catalog Items. Under \$1559 List. 20% PREMIUM (Plus shipping and crating charges if applicable)

**LEVEL 2** -- Completed in 3-4 Weeks and Ships UPS or on Next Available SCB Truck if too large to ship UPS, Unless Commercial Carrier Arrangements are Made at Dealers' Expense. Items available: All Standard Catalog Items. Under \$6235 List. (Plus shipping and crating charges if applicable)

**These shipment dates are guaranteed by Bertch. Any Shipment not meeting the committed shipment date will have the premium charge waived, however, shipping and/or crating will remain the responsibility of the dealer. Delivery of less than 6 cabinets will have a \$180.00 drop charge added to the order.**

BCM Order#:	Acct#	Order Date:	Job Name:	Ship VIA:	
Order Type:		Est Ship Date:	Dealer PO#:	Sold By:	# of Pages:
	Bill To:	Sold To:		Ship To:	
Name & Address:					
Phone:					
Email:					
Fax:					

DELIVERY OF LESS THAN SIX CABINETS WILL HAVE A \$180.00 LIST DROP CHARGE.

DOOR	UPPER	LOWER	DRAWER
Style:			<input type="checkbox"/> Slab
Profile/Panel:			<input type="checkbox"/> 5-Piece
Material/Species:			
Finish:			

BOX	FINISH
Style Series:	Finish:
Material/Species:	Sheen:
Construction: <input type="checkbox"/> Standard <input type="checkbox"/> All Plywood	Finish Traits:
Wood Traits:	Glaze Color:
	Glaze Application:

FRAMED	CASEWORK	ELAN	FRAMED	DRAWER BOX/GLIDE	ELAN
<input type="checkbox"/> Standard (Birch Natural Laminate)	<input type="checkbox"/> Birch Natural Laminate (Standard Option)		<input type="checkbox"/> Dovetail Softmotion (default)	<input type="checkbox"/> Dovetail Softmotion (Default)	
<input type="checkbox"/> All Plywood (Birch Veneer)	<input type="checkbox"/> White Laminate (Standard Option)			<input type="checkbox"/> Tandem	
	<input type="checkbox"/> All Plywood (Birch Veneer)				

ITEM#	ITEM	QTY	HINGE	FINISH ENDS	ITEMIZED INSTRUCTIONS	UNIT PRICE	EXTENSION



MAILING ADDRESS: P.O. Box 2280, Waterloo, Iowa 50704  
 SHIPPING ADDRESS: 4747 Crestwood Drive, Waterloo, Iowa 50702  
 P: 319-268-2592 F: 1-800-973-1200 E: kitchen+@bertch.com

## REPLACEMENT PARTS ORDER FORM

Kitchen+     Elan

Reference Original BCM: \_\_\_\_\_

Reason For Replacement: \_\_\_\_\_

REPLACEMENT ORDERS EXCEEDING \$935 LIST PRICE REQUIRE FIELD INSPECTION AND SIGNED AUTHORIZATION BY THE BERTCH SALES REPRESENTATIVE, ORIGINAL CABINETS OR PARTS MUST BE RETURNED TO BERTCH FOR CREDIT.

THESE ORDERS WILL BE COMPLETED WITHIN 8 CALENDAR DAYS. THOUGH SHIPMENT MUST BE ARRANGED ON THE NEXT AVAILABLE SCB TRUCK INTO YOUR AREA. PLEASE CHECK WITH YOUR DEALER SERVICES REPRESENTATIVE FOR SHIPPING DATE.

BCM Order#:	Acct#	Order Date:	Job Name:	Ship VIA:	
Order Type:		Est Ship Date:	Dealer PO#:	Sold By:	# of Pages:
	Bill To:	Sold To:		Ship To:	
Name & Address:					
Phone:					
Email:					
Fax:					

DELIVERY OF LESS THAN SIX CABINETS WILL HAVE A \$180.00 LIST DROP CHARGE.

DOOR	UPPER	LOWER	DRAWER
Style:			<input type="checkbox"/> Slab
Profile/Panel:			<input type="checkbox"/> 5-Piece
Material/Species:			
Finish:			
BOX		FINISH	
Style Series:		Finish:	
Material/Species:		Sheen:	
Construction:	<input type="checkbox"/> Standard <input type="checkbox"/> All Plywood	Finish Traits:	
Wood Traits:		Glaze Color:	
		Glaze Application:	

FRAMED	CASEWORK	ELAN	FRAMED	DRAWER BOX/GLIDE	ELAN
<input type="checkbox"/> Standard (Birch Natural Laminate)	<input type="checkbox"/> Birch Natural Laminate (Standard Option)		<input type="checkbox"/> Dovetail Softmotion (default)	<input type="checkbox"/> Dovetail Softmotion (Default)	
<input type="checkbox"/> All Plywood (Birch Veneer)	<input type="checkbox"/> White Laminate (Standard Option)			<input type="checkbox"/> Tandem	
	<input type="checkbox"/> All Plywood (Birch Veneer)				

ITEM#	ITEM	QTY	HINGE	FINISH ENDS	ITEMIZED INSTRUCTIONS	UNIT PRICE	EXTENSION

## KITCHEN+/ELAN CUSTOM FINISH MATCH FORM

BCM Order#:	Acct#	Order Date:	Job Name:	Ship VIA:
Order Type:	Est Ship Date:	Dealer PO#:	Sold By:	# of Pages:
	Bill To:	Sold To:	Ship To:	
Name & Address:				
Phone:				
Email:				
Fax:				
DOOR	UPPER	LOWER	DRAWER FRONT	
Style:				<input type="checkbox"/> Slab
Profile/Panel:				<input type="checkbox"/> 5-Piece
BOX			FINISH	
Style Series:	<input type="checkbox"/> Kitchen+ <input type="checkbox"/> Elan		Finish:	
Construction:	<input type="checkbox"/> Standard <input type="checkbox"/> All Plywood		Sheen:	
Wood Species:			Finish Traits:	
Wood Traits:			Glaze Color:	
			Glaze Application:	

\*Glaze kitchen product requires a half door and a custom number, excluding samples and Bath package colors.  
 All cabinet programs that have a color match must be processed in the same manner following the Custom match program.  
 Color match will be supplied within 2 weeks after sample is received for matching.

<input type="checkbox"/> <b>PAINT MATCH</b>	<input type="checkbox"/> <b>CUSTOM FINISH</b>
SHEEN: <input type="checkbox"/> Matte <input type="checkbox"/> Semi Gloss	SHEEN: <input type="checkbox"/> Matte <input type="checkbox"/> Semi Gloss
SHERWIN WILLIAMS Color Name & Number:	DOOR STYLE:
BENJAMIN MOORE Color Name & Number:	WOOD SPECIES:
Paint Match will be supplied on a color chip within 2 weeks. \$886 set-up fee + 15% on order. Color Sample is good for 9 months.	Custom Stain, Custom Paint or Custom Multi-Step finish with sample provided for matching. Color match will be provided on a half door for approval. \$886 set-up fee + additional custom up-charge. Color sample is good for 9 months.

<input type="checkbox"/> <b>BERTCH COLOR MATCH</b> <i>(For Current Finishes Over 1 Year Old)</i>	<input type="checkbox"/> <b>GLAZE SAMPLE REQUEST</b>
ORIGINAL BCM#:	DOOR STYLE:
DOOR STYLE:	WOOD SPECIES:
WOOD SPECIES:	STAIN OR PAINT COLOR:
For current Bertch Colors over 1 year old. Color match will be provided on a half door for approval. \$227 set-up fee + additional custom up-charge. Color Sample is good for 9 months.	GLAZE COLOR: <input type="checkbox"/> Black <input type="checkbox"/> Brown <input type="checkbox"/> Grey
	GLAZE APPLICATION: <input type="checkbox"/> Soft <input type="checkbox"/> Full <input type="checkbox"/> Brushed
	Glaze finishes will be viewed on a 1/2 door for approval. \$227set up fee with standard glaze pricing on order. Color sample is good for 9 months.